

REPAIR MANUAL





CONTENTS

1. Products specification	2
2. Out look	3
3. Names of principal parts	4
4. Removing methods of external parts	
4.1 Face plate.....	5
4.2 Free arm cover	5
4.3 Base plate.....	5
4.4 Back cover.....	5
4.5 Front cover	6
5. Adjusting methods of each part	
5.1 Symbol instructions	7
5.2 Play of arm shaft.....	7
5.3 Play of arm shaft worm and pattern cam.....	8
5.4 Drop middle point of needle.....	8
5.5 Height of presser foot	9
5.6 Needle flow at maximum zigzag width	10
5.7 Drop middle point of needle.....	11
5.8 Needle position of zigzag	12
5.9 Height of needle bar	13
5.10 Automatic needle threader adjustment.....	14
5.11 Distance-needle-hook.....	15
5.12 Timing of needle and hook	16
5.13 Distance adjustment between shuttle driver shaft gear complete and lower shaft gear complete	17
5.14 Play between shuttle driver shaft gear and lower shaft gear.....	18
5.15 Feed cam position adjustment.....	19
5.16 Feed lifting rock cam position adjustment	19
5.17 Feed-dog height	20
5.18 Position of the feed-dog in relation to the needle plate (front to back)	21
5.19 Position of feed-dog in relation to the needle plate (left to right)	22
5.20 Upper thread tension adjustment	23
5.21 Lower thread tension adjustment	24
5.22 Motor belt tension	25
5.23 Reverse patterns	26
5.24 Forward and reverse stitching in buttonhole sewing (feeding pitch of reverse and forward stitching is not even).....	27
5.25 Buttonhole upper and lower stitching problem	28
5.26 Bobbin winding problem	29
6. Circuit diagram.....	30



ATTENTION

Be sure to observe the following, as they may well become causes for fire, electric-shock, injuries, and damage to parts.

- Be sure to unplug power source before engaged in disassembly, installation, adjustment.
- In case of installing please pay special care to clamp electrical cords, etc., scars to sheath, mis-circuit, etc.
- Be sure to use regular standard part in replacing.

1. Products specification

ITEM	TYPE	KXOL		
		SPARROW 15		
Machine style	Free arm			
Size of machine (mm) L x W x H	398 x 169 x 298.5 mm			
Weight (kg)	6 (only machine)			
Max rotation speed (rpm)	750±50 rpm			
Rated voltage	North America AC 120V		Europe AC 230V	
Motor power	North America 70W		Europe 70W	
Motor type	AC Option (Auto type)			
Needle position	Center and left position			
Zigzag out-breaking device	Multiple-player cams conversion type			
Hook system	Semi rotary hook			
Thread take up lever	Slit type			
Presser foot lift	Two-steps type			
Needle threader	Manually	Auto type	Auto type	
Needle plate	Screw fixing type			
Upper thread tension adjust device	Top of upper plate inclusive turning knob			
Bobbin winder	Self releasing with automatic stop			
Reverse	Press down type			
Kinds of stitches	32			
Dials	3			
Stitch length adjust device	Dial type			
Max. length of stitch (mm)	4.0 ~ 4.5mm			
Max. width of zigzag (mm)	4.6 ~ 5.0mm			
Face plate upper plate	Plastic			
Sewing table	Coupled with accessories / Spare parts box			
LED Lamp	Inclusive within face plate			
Speed control device	Controller			
Power supply switch	Pulsating, two steps			
Protective cover	Option			
Nos. of accessories	Option			

2. Out Look

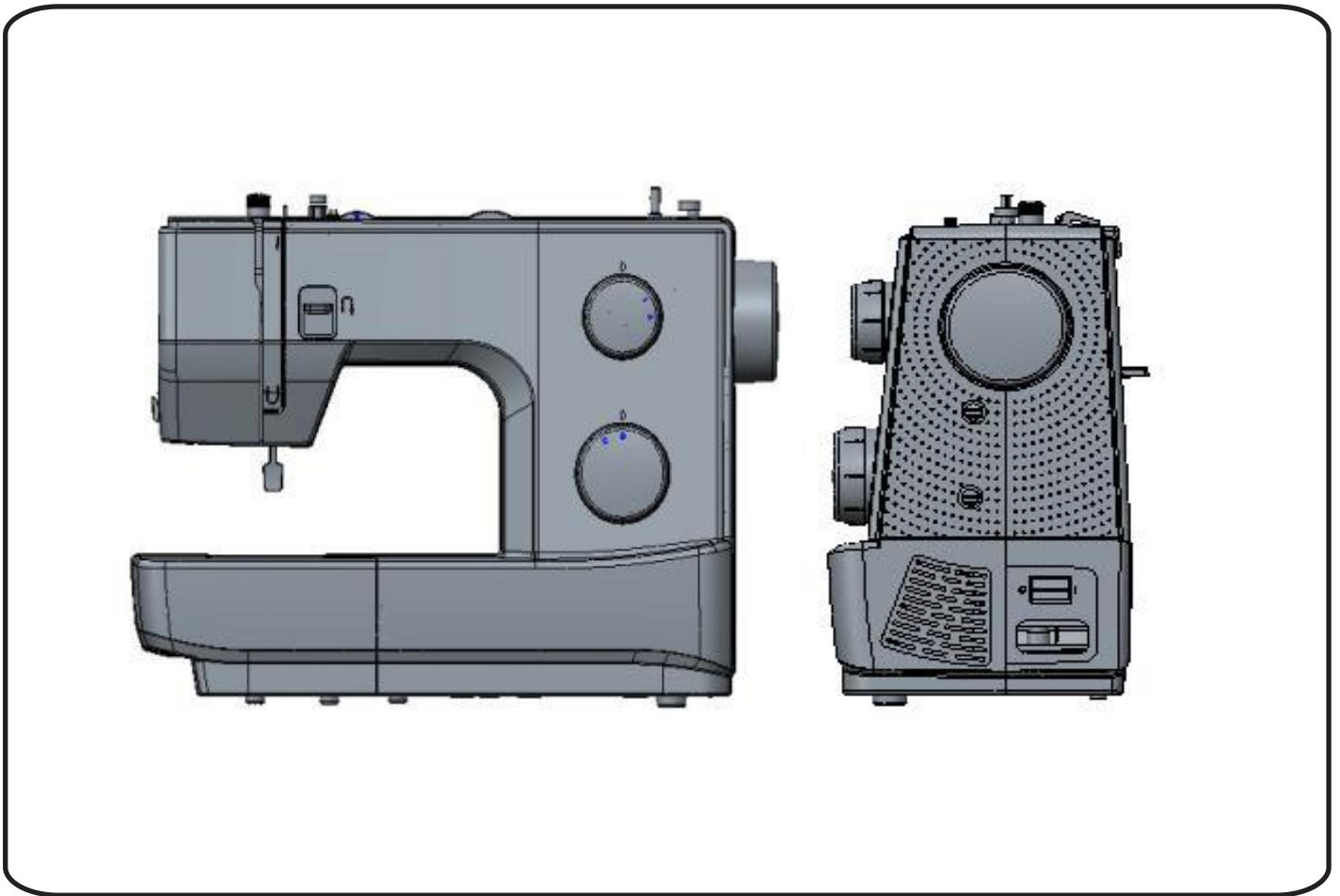

3. Names of principal parts

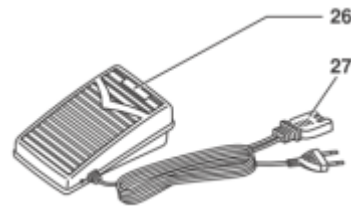
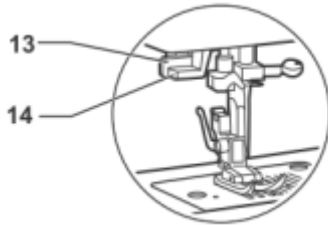
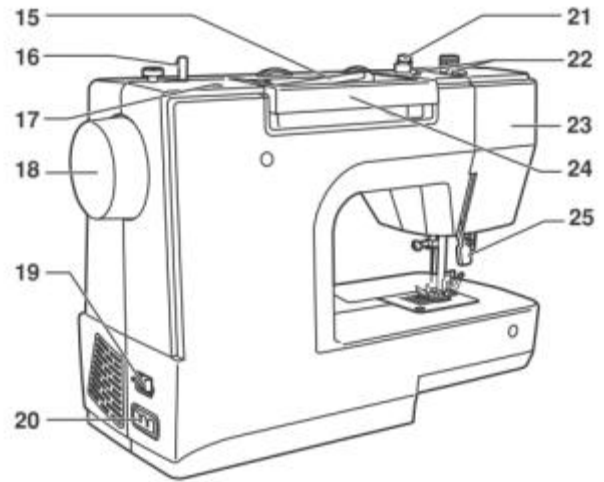
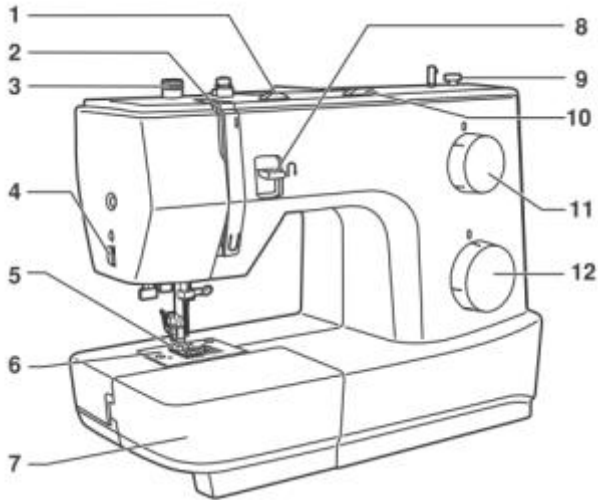

1. Thread tension dial
2. Thread take-up lever
3. Presser foot pressure adjustment
4. Thread cutter
5. Presser foot
6. Needle plate
7. Sewing table and accessory box
8. Reverse sewing lever
9. Bobbin wider stopper
10. Stitch width dial (for sew&go 5)
11. Stitch length dial
12. Pattern selector dial
13. One step buttonhole lever (for sew&go 5)
14. Automatic threader (optional)

15. Horizontal spool pin
16. Bobbin winder spindle
17. Hole for second spool pin
18. Handwheel
19. Power switch
20. Main plug socket
21. Bobbin thread guide
22. Upper thread guide
23. Face plate
24. Handle
25. Presser foot lifter
26. Foot control
27. Power cord

4. Removing methods of external parts

4-1 Face plate

Remove the screw (a) and the face plate. ①

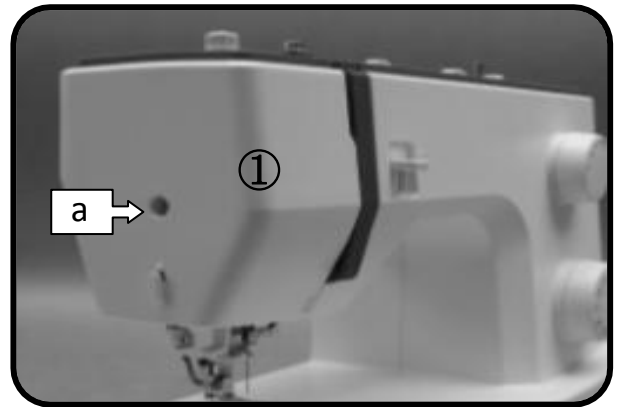

4-2 Free arm cover

Remove the screw (b) and the free arm cover. ②

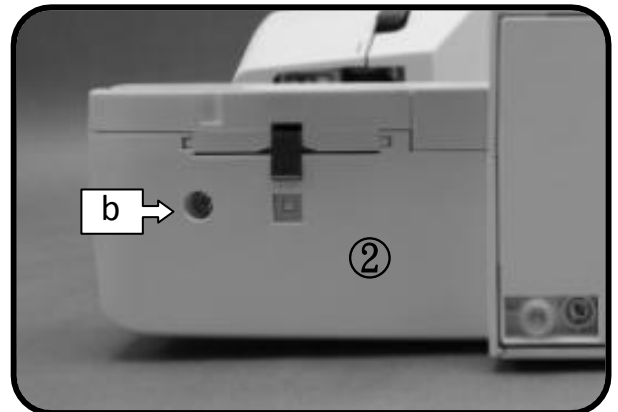

4-3 Base plate

- Lay down machine. Remove 4 screws (c, d, e, f).
- Remove the base plate. ③

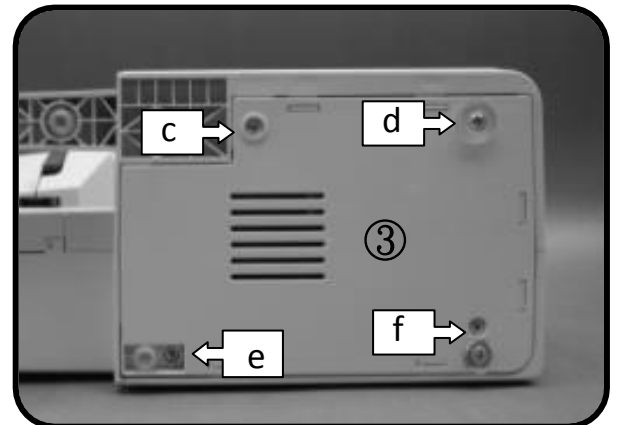

4-4 Back cover

- Remove the face plate, cap, free arm cover, and base plate first.
- Lift spool rod and remove 4 screws (g, h, i, j).
- Loosen screw (k) about 3mm.
- Remove the back cover. ④

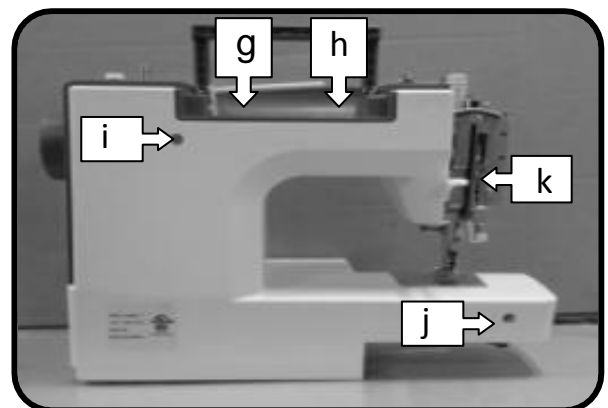

4-5 Front cover

- Loosen screw (l) about 3mm.

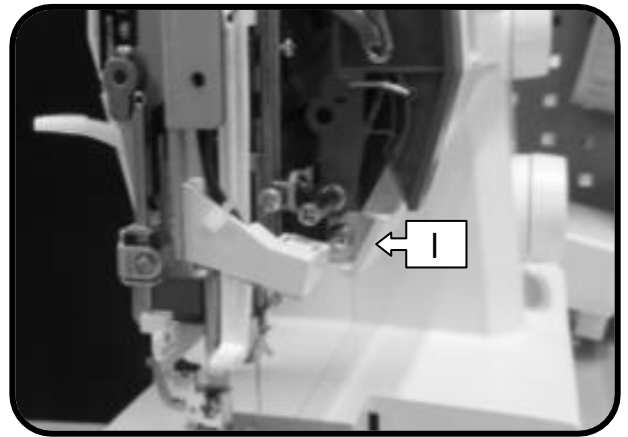

- Remove the screw (m) which deeply inside the machine.

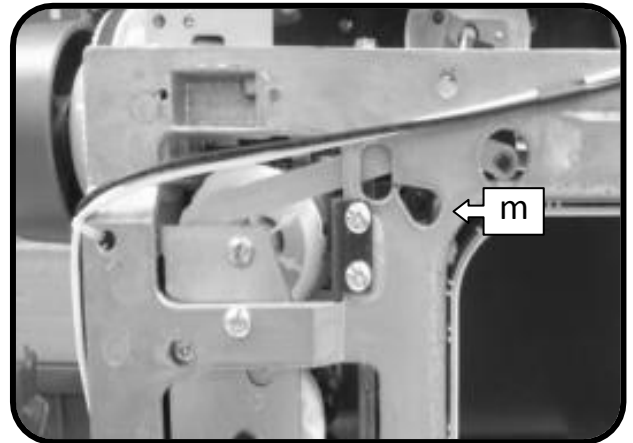

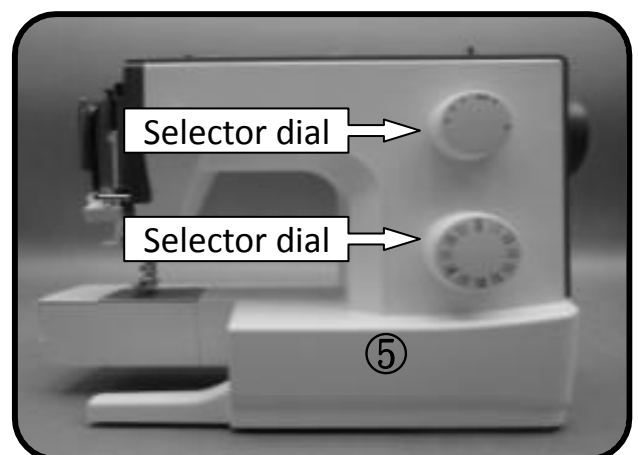

- Remove the pattern selector dial.
- Remove the front cover following direction of arrow. ⑤





5. Adjusting methods of each part

5-1 Symbol instructions

 Noise occur while the machine is running.

 Delivery of cloth to be in disorder and insufficient, problems associated with delivery amount.

 BH right and left stitching is not even, incorrect length and problems associated with buttonhole sewing.

 Skip-over stitching, needle breakage, and problems associated with needle.

 Stitch tightening problem.

 Bobbin winding problem.

5-2 Play of arm shaft

1) Remove the face plate, free arm cover, base plate, back cover, front cover and loosen screws (a, b) of arm shaft collar (A). (1)

2) Pull hand wheel backward.

3) Push arm shaft collar (A) to left tightly against arm shaft bushing (B). Then fasten and secure screws (a, b). (1)

4) Be sure proper distance between arm shaft collar and arm shaft bushing. (2)

5) Be sure arm shaft operates smoothly after adjustment.

6) Arm shaft collar and arm shaft bushing being too tightly closed might cause insufficient operation of arm shaft.

7) Follow steps 1, 2, 3 in order to re-adjust.

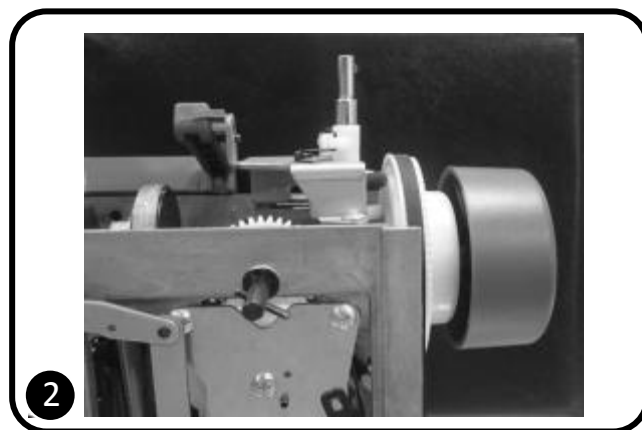
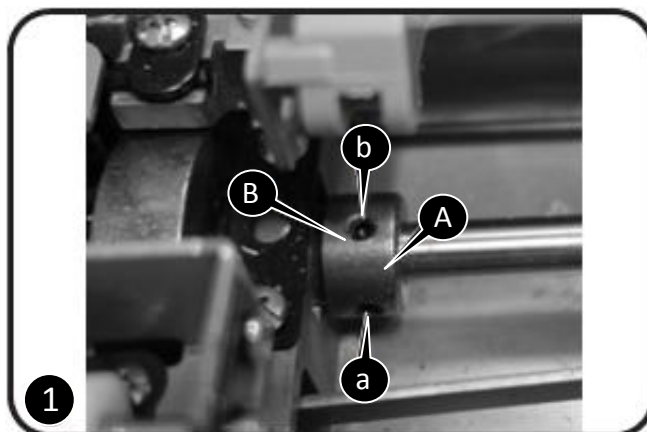

5-3 Play of arm shaft worm and pattern cam

- 1) Remove the face plate, free arm cover, base plate, back cover, front cover and loosen screw (a) of arm shaft worm.
- 2) Push arm shaft worm (A) to right to mesh with gear of pattern cam (B). Then fasten screw.
- 3) Confirm proper tightness by checking pattern cam gear's movement.
- 4) The insufficient tightness could be re-adjusted by following steps 1, 2.
- 5) Re-confirm needle flow after above adjustment is necessary.

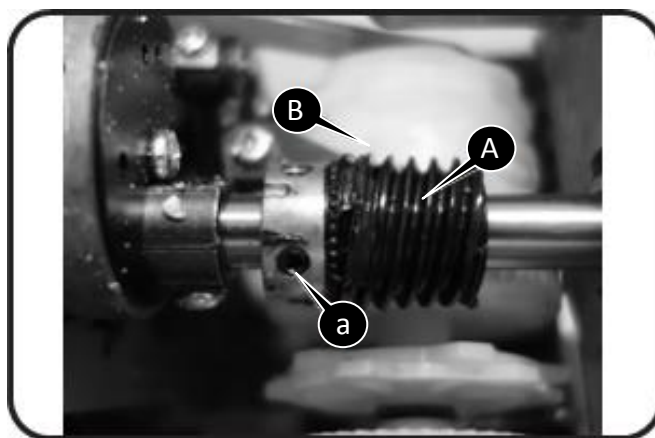

5-4 Drop middle point of needle

- 1) Remove the face plate.
- 2) Loosen screw (a) of needle bar supporter. (A)
- 3) Turn needle bar supporter (A) forward / backward to adjust needle.
Backward ⇌ to move needle forward
Forward ⇌ to move needle backward
- 4) Set needle position above center of needle plate and fasten screw (a).

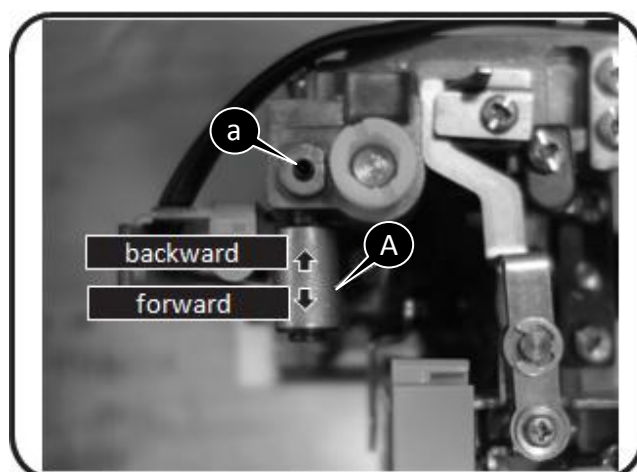

5-5 Height of presser foot

- 1) Remove the face plate and lift up presser bar lifter lever (A). (1)
- 2) Loosen screw (a) of presser bar bracket with the hexagon screwdriver (3mm). (1)
- 3) Place gauge (B) (6.0 - 6.5mm) on top of needle plate. (2)
- 4) Lift up presser bar lifter lever so bottom of presser foot and top surface of gauge would meet.
- 5) Secure tightly screw (a).
- 6) The correct setting of gauge should be 6.0 - 6.5mm.

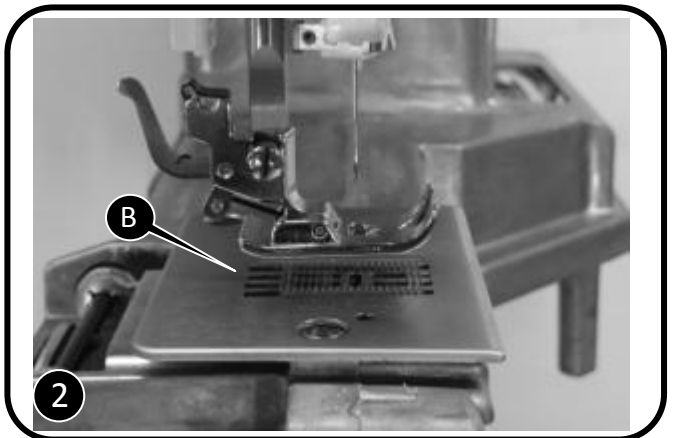
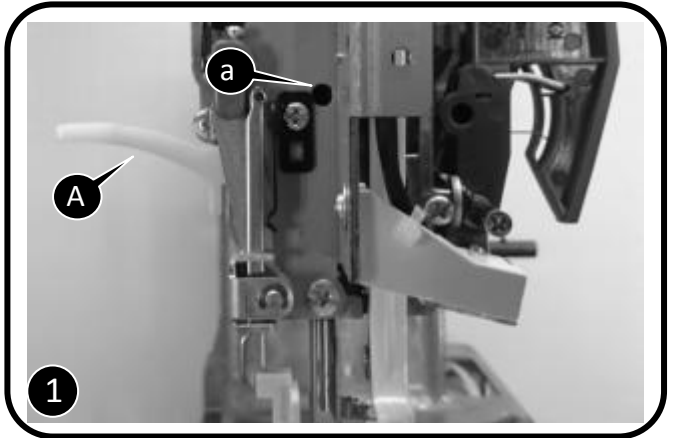

5-6 Needle flow at maximum zigzag width

- 1) Remove the face plate, free arm cover, base plate, back cover and front cover.
- 2) Set pattern selector dial to " \approx ".
- 3) Set needle bar at its lowest point when it swings to left. Turn hand wheel to move the needle bar upward. The vertical distance in which the needle point goes up at the left position from the top of the needle plate should be 3 - 5mm. (1)
- 4) If needle flow is less than 3mm, loosen arm shaft worm screw (a) and turn arm shaft worm (A) toward back. (2)
- 5) If needle flow is more than 6mm, turn arm shaft worm (A) toward front. (2)
- 6) After adjustment. Secure tightly arm shaft worm screw.
- 7) To be sure arm shaft operate smoothly after adjustment.
- 8) Otherwise, gearing match of arm shaft worm gear and pattern cam gear could be too big. To correct this problem, follow adjustment 5-3. (P.S. Re-adjustment of needle flow is necessary after adjustment)

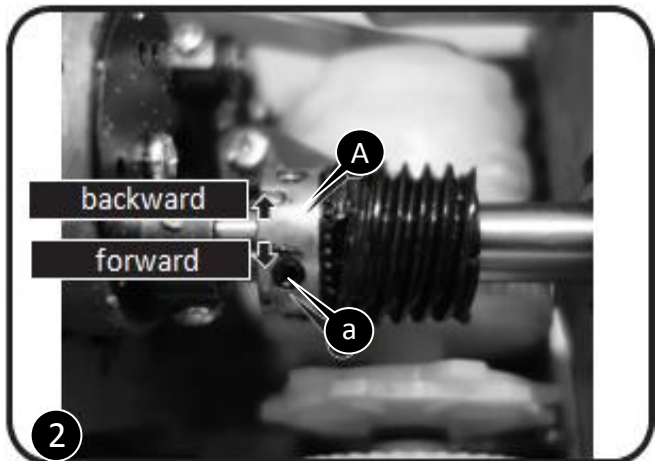
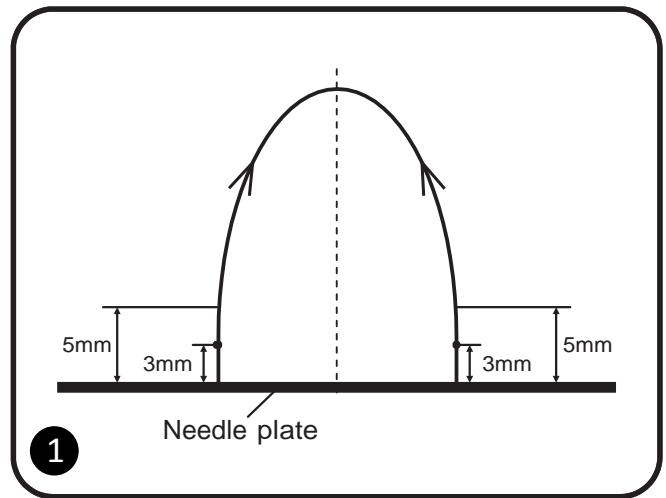

5-7 Drop middle point of needle

- 1) Remove the face plate, free arm cover, base plate and back cover first.
- 2) Set pattern selector dial to " | ", stitch width dial " ∞ " (for 3-dial model).
- 3) Loosen screw (a), then adjust screw unit (b). (1)
- 4) clockwise needle moves left
counter-clockwise needle moves right
Make sure needle drops on middle of needle hole. (2)
- 5) Tighten screw (a).

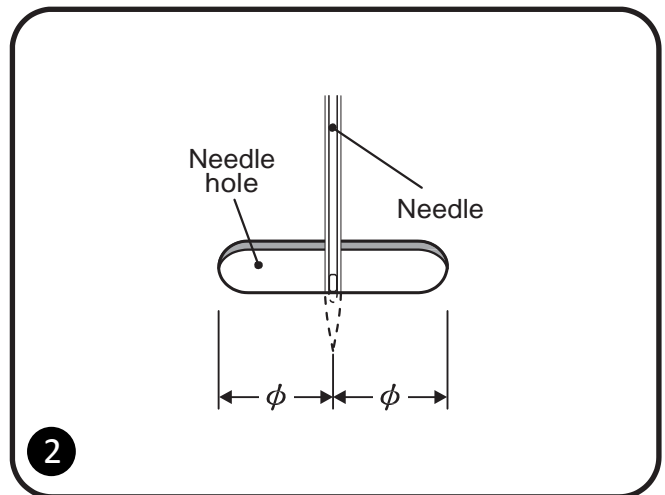
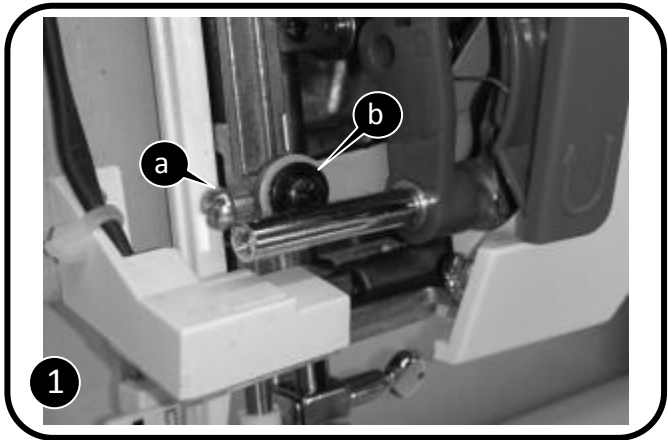

5-8 Needle position of zigzag



- 1) Remove the face plate.
- 2) Set pattern selector dial to "  ". (maximum zigzag width)
- 3) Loosen nut (a) of the screw(b). (1)
- 4) Adjust needle by turning screw(b) clockwise / counter-clockwise.
- 5) Make sure needle drops on left / right of needle hole with even distance to the edge of needle hole. (2)
- 6) After adjusting, re-tighten nut (a).

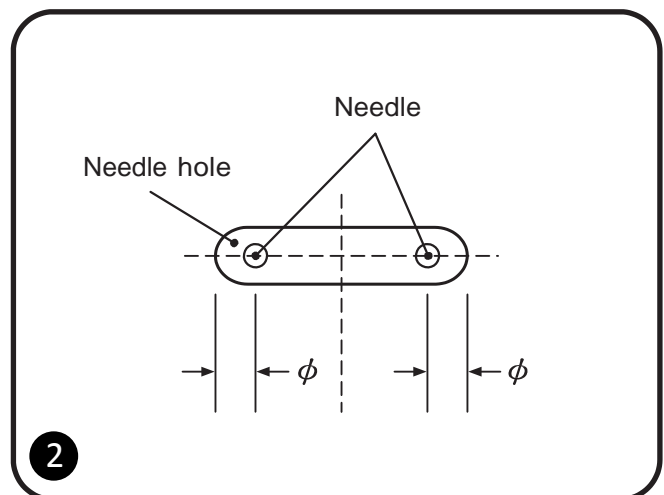
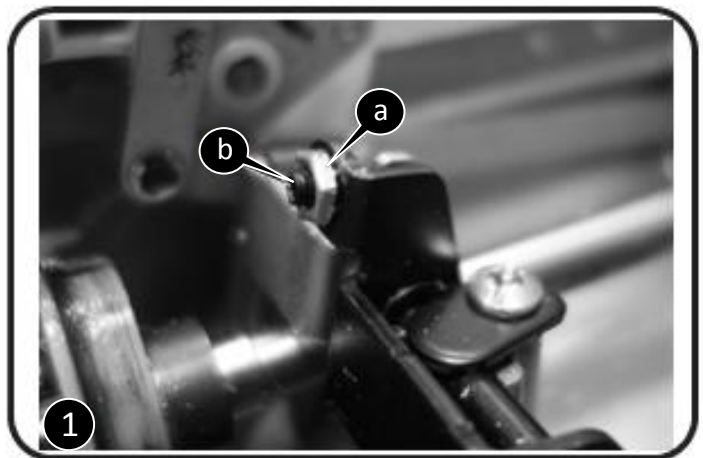

5-9 Height of needle bar

- 1) Remove the face plate and free arm cover.
- 2) Remove shuttle hook.
- 3) Place the gauge of diameter 23mm into the center of the hook. (1).
- 4) Set needle at its lowest point, stop at the position when point of the needle across the edge of the gauge. (1)
- 5) Loosen screw (a). (2)
- 6) Adjust height of needle by moving needle bar (B) upward / downward.(2)
- 7) The correct setting of gauge should be 23mm.
- 8) After adjusting, re-tighten screw (a).

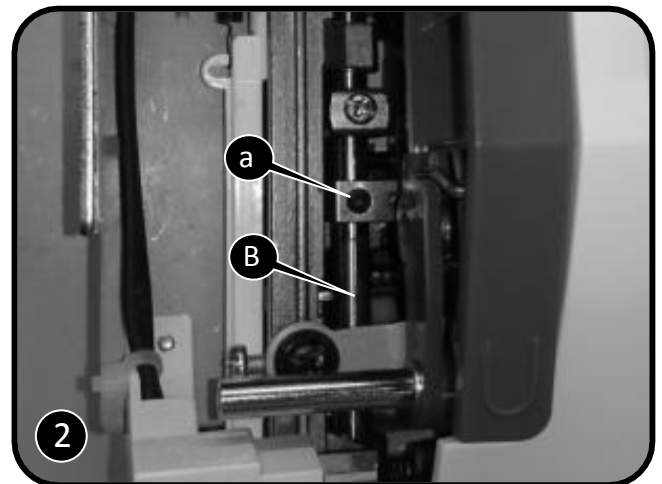
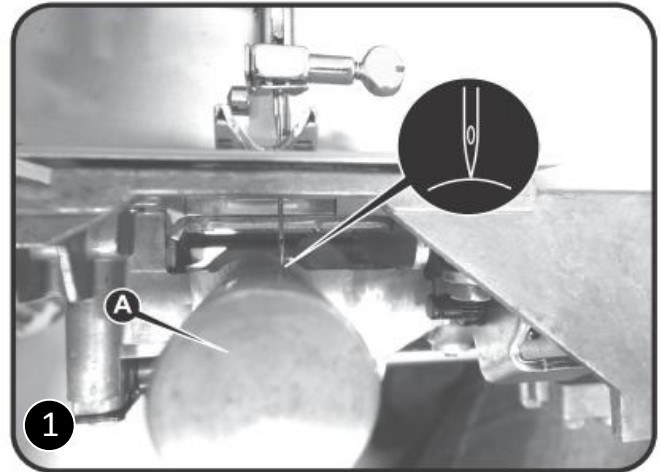

5-10 Automatic needle threader adjustment



- 1) Check the threader hook.
If it is damaged, change new one.
If it is inclined, adjust the threader hook properly.
- 2) If the threader hook can not enter needle hole freely, please adjust the threader stopper. (1)
- 3) Adjust the stopper: (2)
 - Remove face plate and turn hand wheel to raise needle bar to its highest position.
 - Loosen screw (a) of the threader stopper (A).
 - Move the stopper (A) upward and the threader hook will become higher.
Move the stopper (A) downward and the threader hook will become lower.
 - Adjust the stopper to the proper position for entering needle hole freely.
 - Fasten the screw (a).

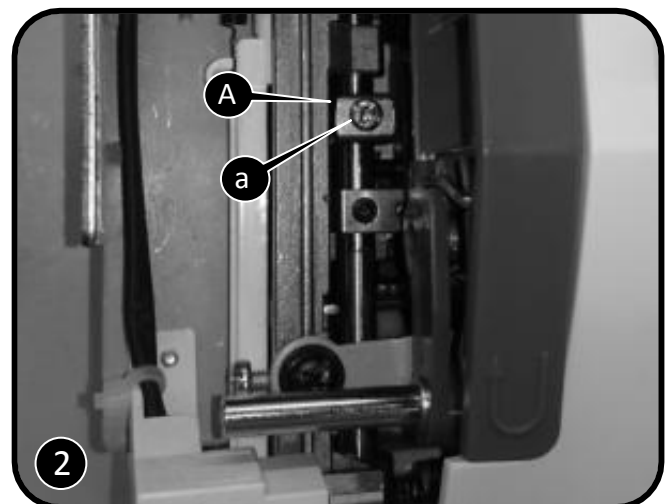
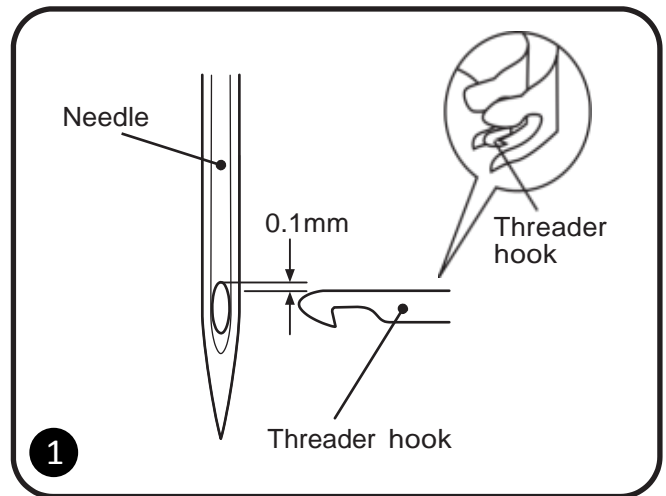

5-11 Distance-needle-hook

- 1) Remove the free arm cover.
- 2) Remove shuttle hook holder (A). (1)
- 3) Set needle at its lowest point when it swings to right, stop at the position when point of the needle and shuttle hook will agree with.
- 4) Loosen screws (a, b) of open shuttle race. (2)
- 5) Move shuttle race (B) upward/downward to adjust movement. (2)
Upward ⇔ tighten the distance
Downward ⇔ lengthen the distance
- 6) Make sure space between needle and tip of hook to be 0.05-0.1mm. (3)
- 7) After adjustment, re-tighten screws.
- 8) Re-assemble back shuttle hook holder.

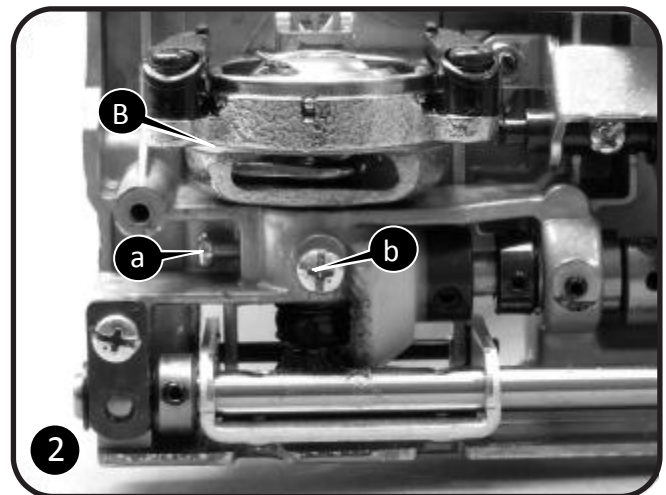
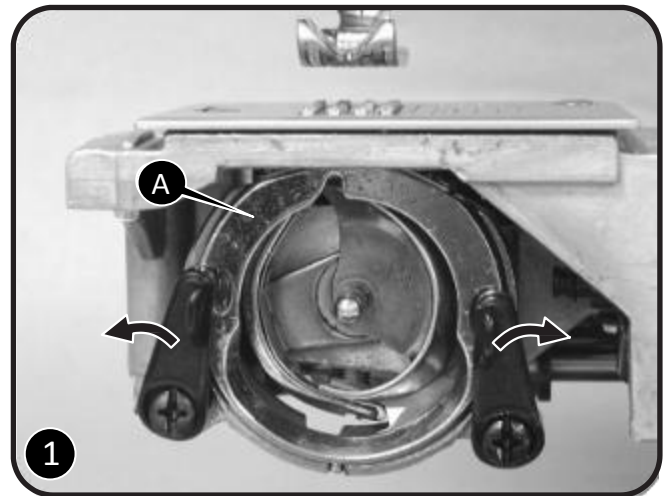

5-12 Timing of needle and hook

- 1) Remove the free arm cover and base plate.
- 2) Remove shuttle hook holder.
- 3) Set needle bar at its highest point and loosen screw (a) of crank connecting rod crank. (1)
- 4) Set needle bar at its lowest point when it swings to left.
- 5) Loosen another screw (b) of crank connecting rod crank. (1)
- 6) Turn shuttle driver (A) to adjust timing of needle and hook. (2)
- 7) Tighten two screws of crank connecting rod crank when clearance between point of hook and upper part of needle eye is 3.2 - 3.4mm. (3)
Clockwise \Rightarrow timing is smaller
Counterclockwise \Rightarrow timing is bigger.
- 8) Re-assemble shuttle hook holder.

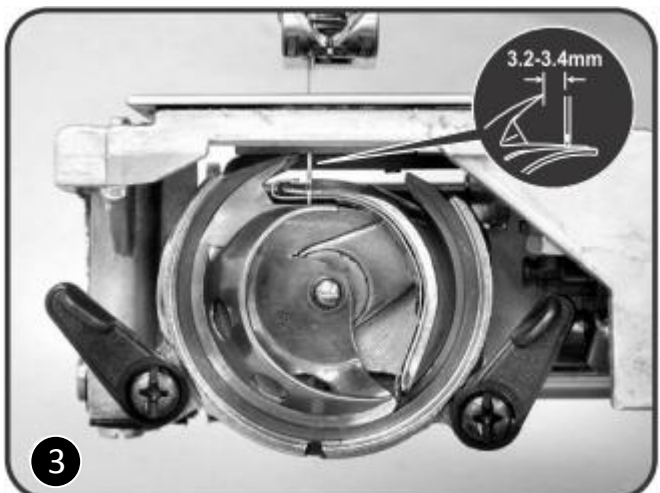
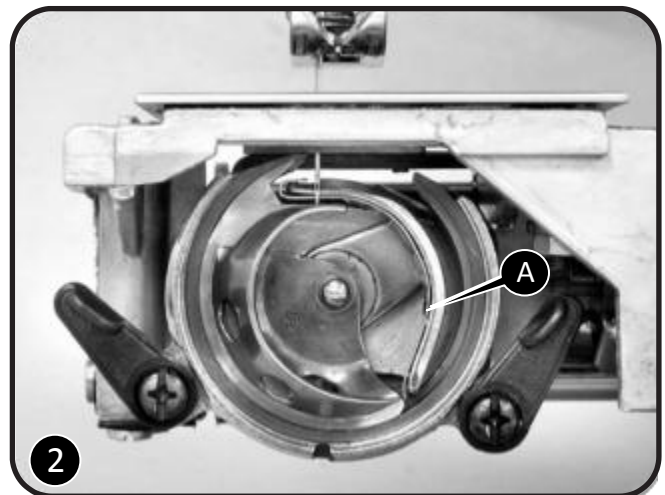
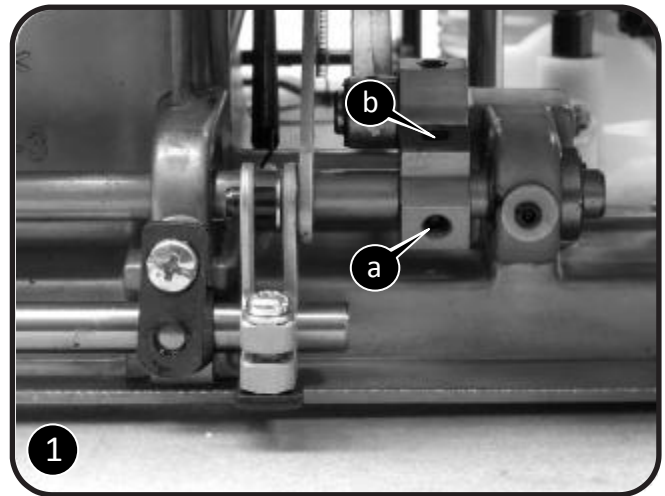

5-13 Distance adjustment between shuttle driver shaft gear complete and lower shaft gear complete

- 1) Remove free arm cover. Proceed to loosen screw (a) and push feed lifting rock cam (A) to right. (1)
- 2) Push lower shaft gear (B) to left tightly against shuttle driver shaft gear complete (C). (2)
- 3) Push feed lifting rock cam (A) back toward left and secure it tightly.
- 4) Avoid over-tightening shuttle driver shaft gear complete and lower shaft gear complete. If gearing match to be big, then the torque will be bigger causing shaking.

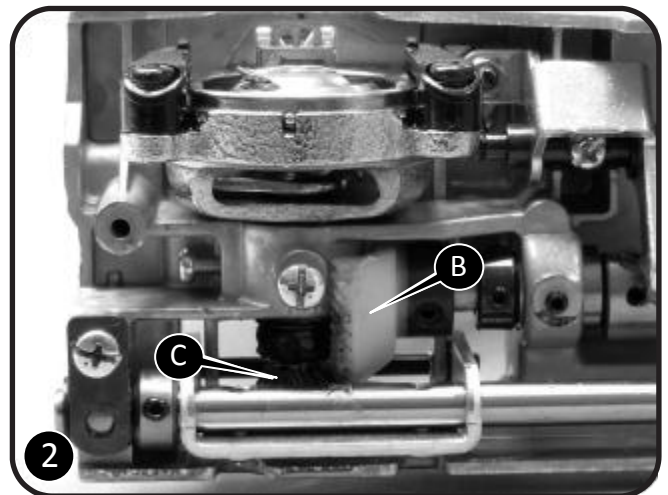
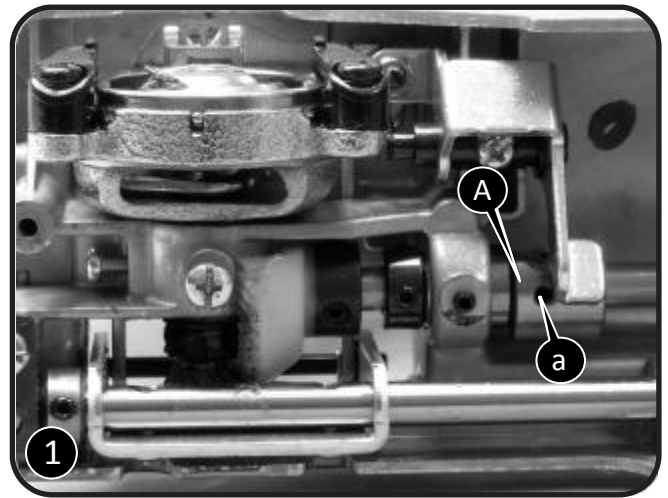

5-14 Play between shuttle driver shaft gear and lower shaft gear

- 1) Remove the face plate, free arm cover, base plate, back cover and loosen screws (a, b) of shuttle driver shaft gear (A). (1)
- 2) Remove shuttle driver shaft gear (A). (1)
- 3) Turn needle to its lowest point and when rear end of shuttle driver shaft comes across descending needle. In this position face cut-facing side of shuttle driver shaft to front. (2)
- 4) Re-assemble back shuttle driver shaft gear, align shuttle driver shaft gear and lower shaft gear (B) to mesh with each other at one point (second teeth location) (3).
- 5) Re-tighten screws of shuttle driver shaft gear. Tighten first screw positioned at cut-facing side of shuttle driver shaft.
- 6) Insert shuttle hook and check timing.
- 7) Re-assemble back shuttle driver shaft.

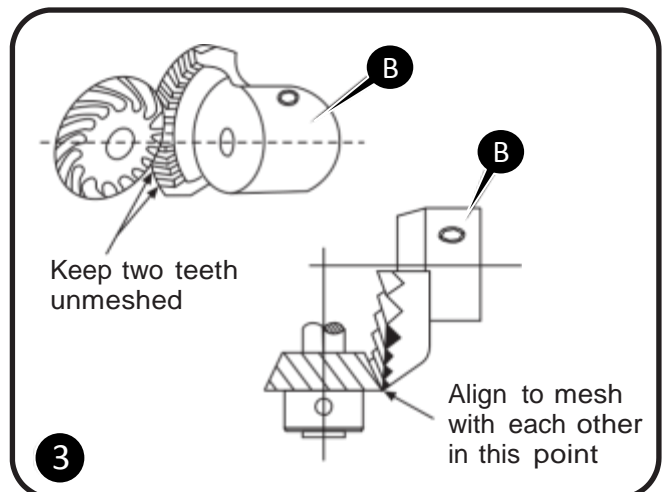
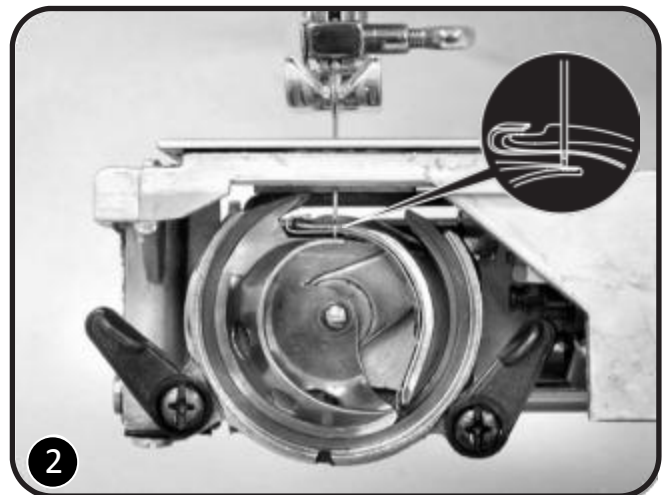
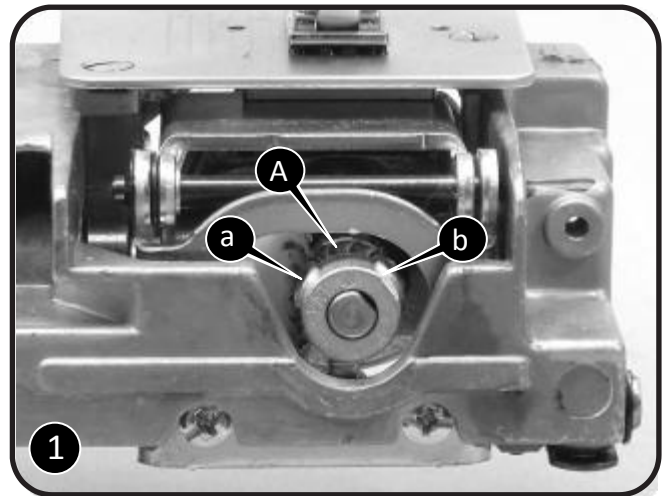

5-15 Feed cam position adjustment

Problems associated with delivery amount, stitch unbalance and needle breakage, make the following adjustments:

- 1) Remove the face plate, free arm cover, base plate, back cover and front cover.
- 2) Loosen screw (a) of feed cam at arm shaft position. Make sure hair line marking on feed cam (A) match correctly with marking of arm shaft (B).

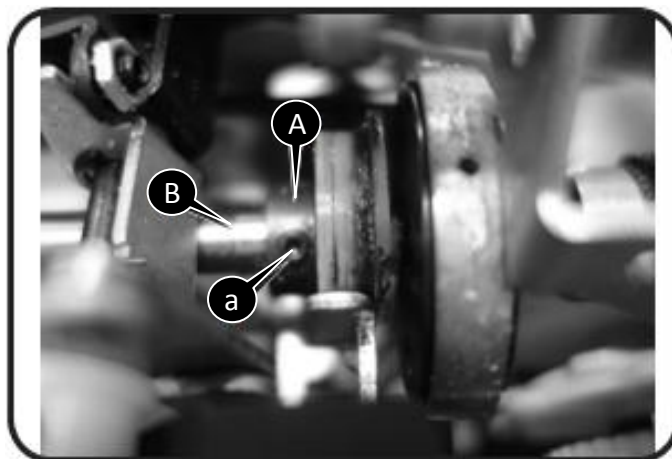

5-16 Feed lifting rock cam position adjustment

Problems associated with delivery amount, stitch unbalance and needle breakage, make the following adjustments:

- 1) Lift needle to its highest position.
- 2) Loosen screw (a) and make sure hair line marking on feed lifting rock cam (A) match correctly with marking of feed lifting rock crank (B). (1)

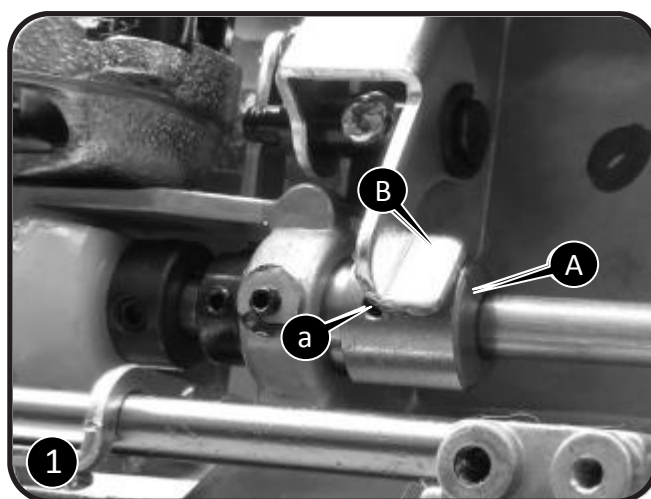

5-17 Feed-dog height

- 1) Remove the free arm cover and lift needle to its highest position.
- 2) Remove presser foot.
- 3) Place setting gauge (A) (0.9 - 1.05mm) on needle plate. The feed dog height then can be checked. (1)
- 4) Press reverse button. At the correct height (0.9mm), the feed-dog will be moved freely forward and backward.
- 5) Turn screw (a) of feed rock crank clockwise / counter-clockwise to adjust height of the feed-dog between 0.9 - 1.05mm. (2)

Clockwise \Rightarrow raise the feed dog

Counter-clockwise \Rightarrow lower the feed dog

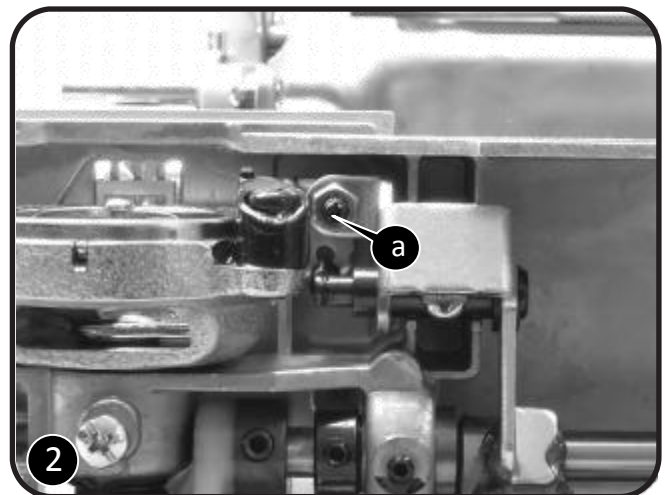
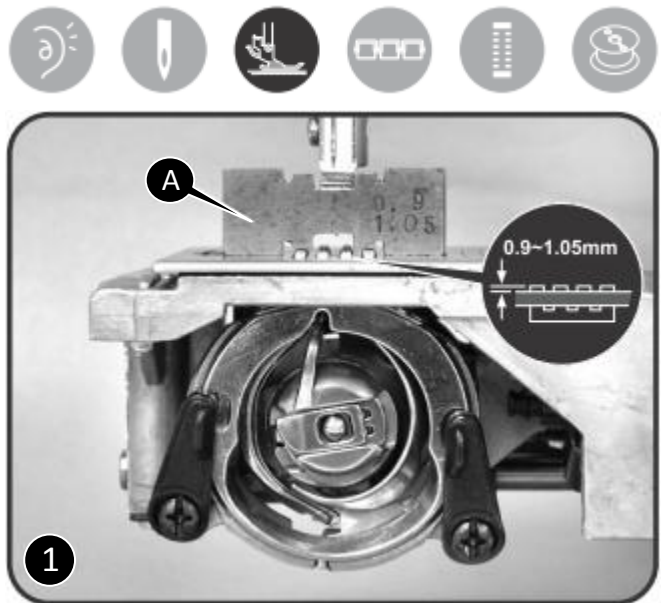

5-18 Position of the feed-dog in relation to the needle plate (front to back)

- 1) Remove the free arm cover, base plate and set the stitch length dial to "4".
- 2) Turn hand wheel to move feed-dog forward and backward.
- 3) Feed-dog must have clearance along the whole length of feeding movement. It must at no time touch the needle plate. (1)
- 4) Otherwise, adjust feed rock crank screw.
- 5) Loosen screw (a) of feed rock crank. Moving feed-dog forward/backward until reaching to the center position. (2)
- 6) Tighten screw (a) after adjustment.

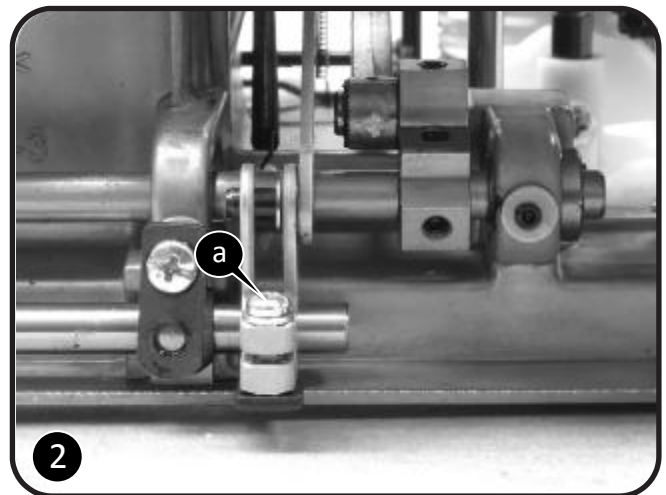
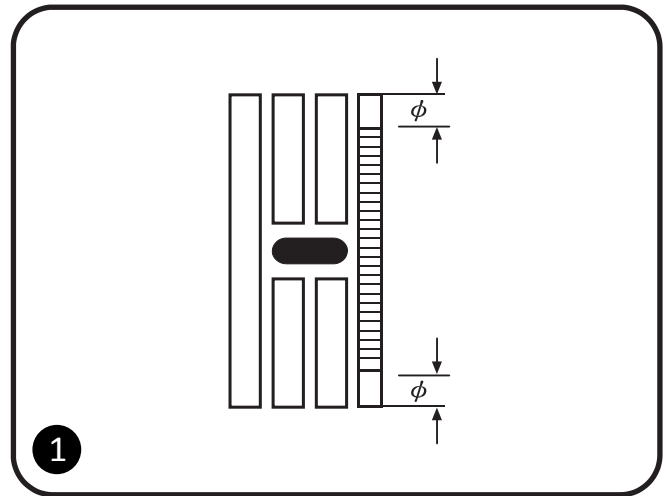

5-19 Position of feed-dog in relation to the needle plate (left to right)

- 1) Remove the face plate, free arm cover, base plate and back cover.
- 2) Loosen screws (a, b). Move feed dog left / right to middle position.
- 3) Tighten screws (a, b) after adjustment.

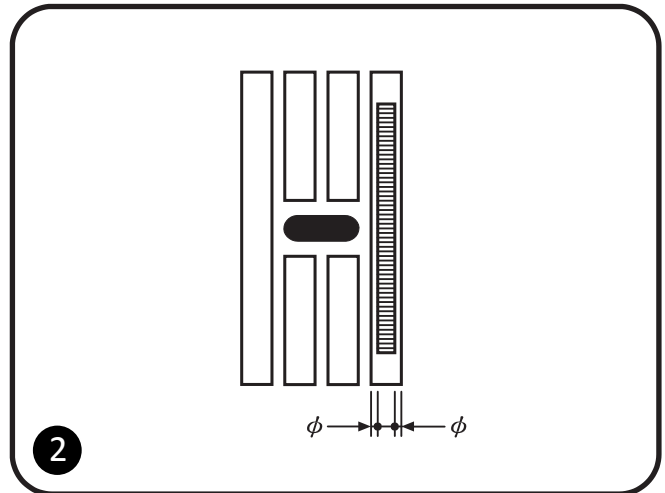
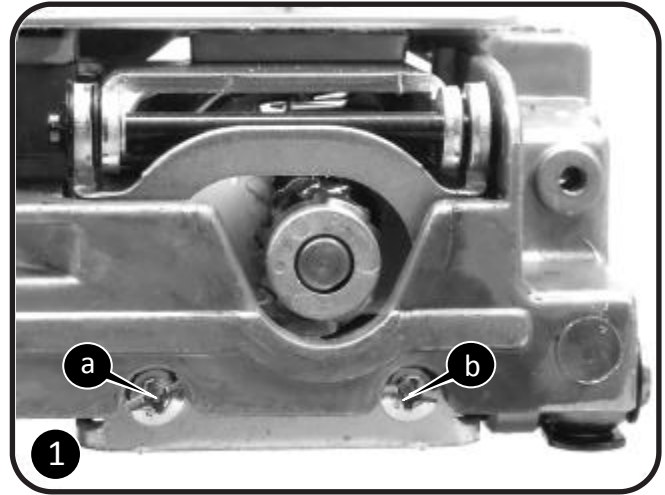

5-20 Upper thread tension adjustment



- 1) Set the tension dial (A) to "4". (2)
- 2) Use a dial tension gauge (150g) (B) to take measurement. (1)
- 3) Put dial tension thread into gauge's hook and pull, and the standard range should be 60 ~ 80g.
- 4) If the range is not between 60 ~ 80g, adjust tension by turning plastic dial (a) forward / backward. (2)

Forward ⇨ weaker

Backward ⇨ stronger

- 5) Re-check tension by above step 1, 2, 3.

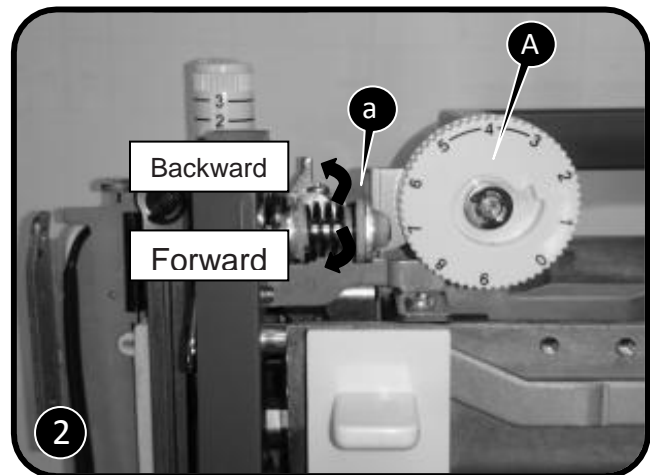
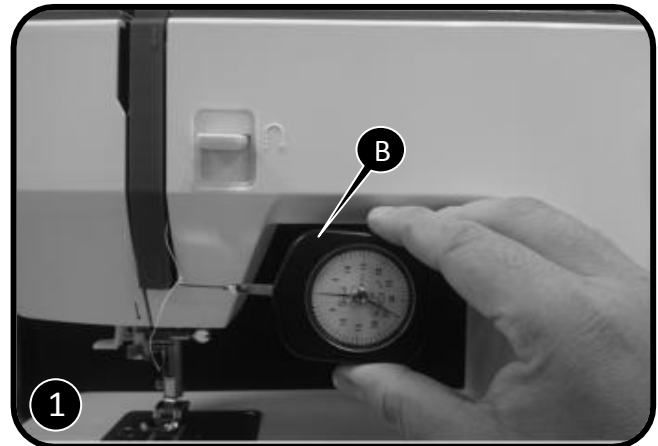

5-21 Lower thread tension adjustment

- 1) For testing use a bobbin with thread and place it in bobbin case. (1)
- 2) Put bobbin case inside bobbin case tension gauge (A) and test its tension. The standard tension should be 25 ~ 40g. (2) If not, adjust by turning screw (a) clockwise / counter-clockwise. (1)

Clockwise = stronger

Counter-clockwise = weaker

- 3) Be sure the bobbin case tension should be accommodated with the upper thread tension amount 60 ~ 80g that measured at dial position "4".

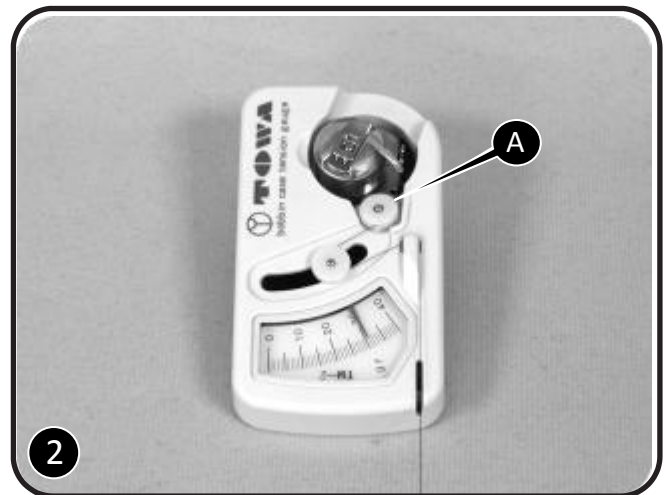
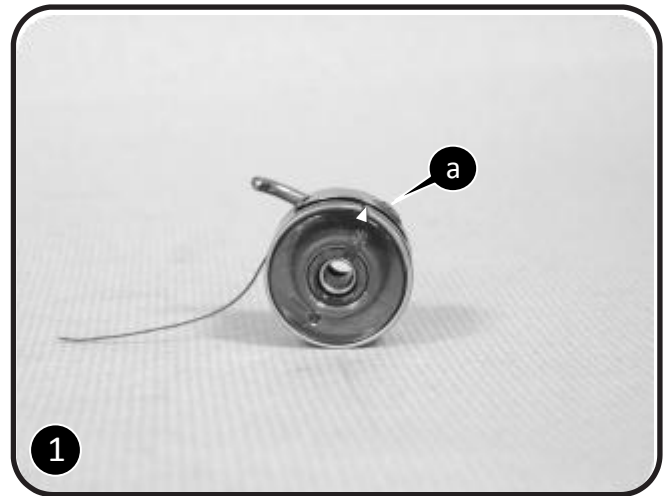

5-22 Motor belt tension

- 1) Remove the back cover, front cover and test tension of motor belt using belt tension gauge (A).

Its standard measurement should be 200g. (1)

- 2) Adjust tension by loosening screws (a, b) of motor bracket (B). (2)

- 3) Lift motor bracket upward/downward to adjust belt tension.

Upward ⇔ weaker

Downward ⇔ stronger

- 4) Re-tighten screws (a, b) after adjustment.

Note: Make sure running speed is proper.

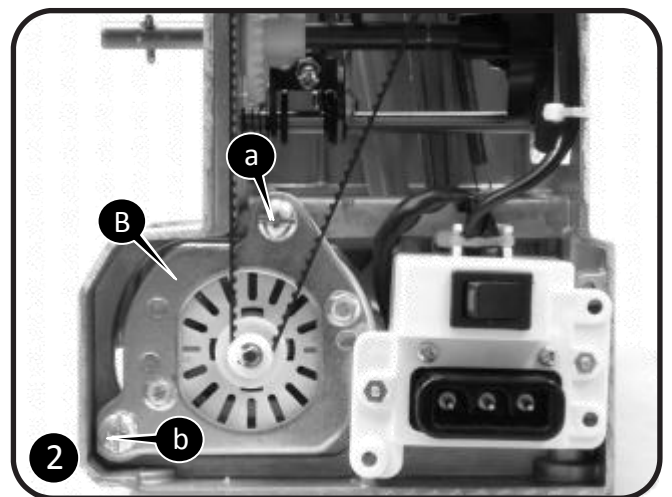
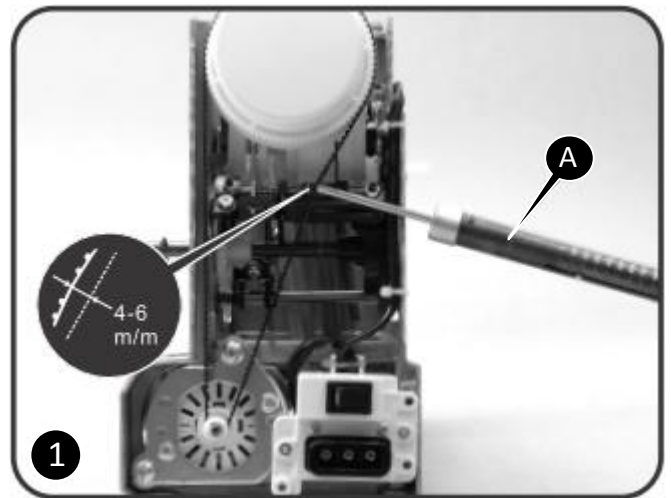



5-23 Reverse patterns

- 1) Remove the back cover, front cover.
- 2) Set pattern selector dial to "3".
- 3) Set stitch length dial at "S1".
- 4) If the patterns are too close, adjust by turning screw (a, b) anti-clockwise. (1, 2)

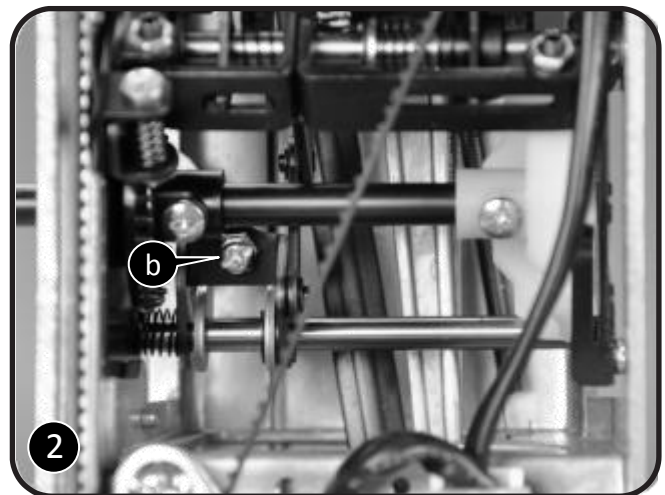
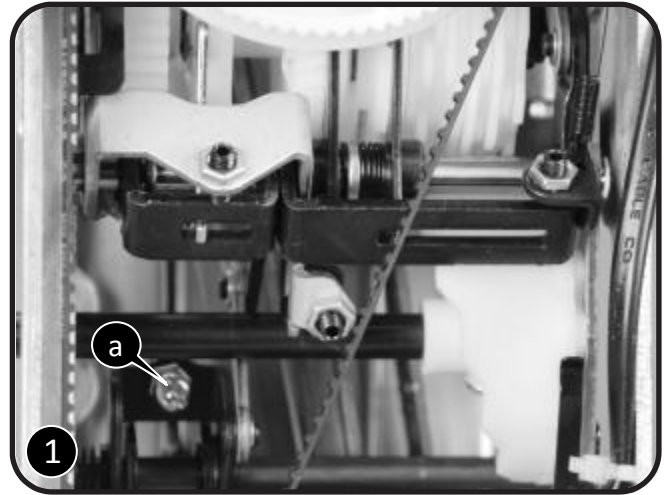
If the patterns are too open, adjust by turning screw (a, b) clockwise. (1, 2)



5-24 Forward and reverse stitching in buttonhole sewing (feeding pitch of reverse and forward stitching is not even)



- 1) Remove the back cover, front cover.
- 2) Set the pattern selector dial to "  " (for 1 / 3 series).
- 3) Sew the right side by setting the selector dial at "  " and then the left side by setting at "  " (for 1 / 3 series).
- 4) Set the stitch length dial at "0.5" to "1".
- 5) To sew by using thread in effect, to confirm delivery amount of forward and backward. (1) If forward and backward delivery amount not match, adjust by turning screw (a, b) of pattern cam contact plate clockwise / counter-clockwise. (2, 3)

Counter-clockwise = strong

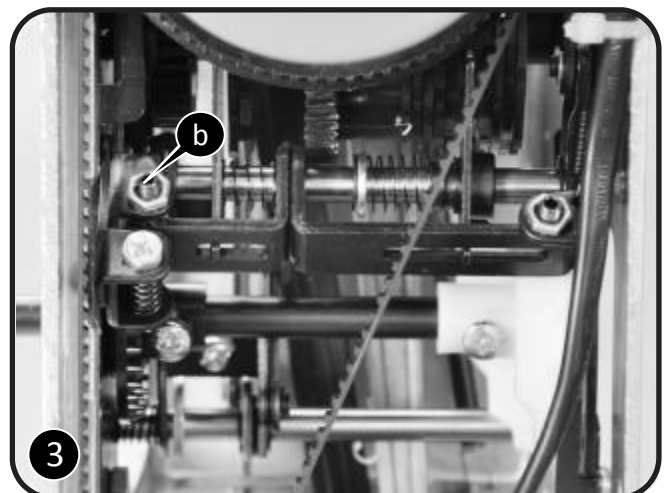
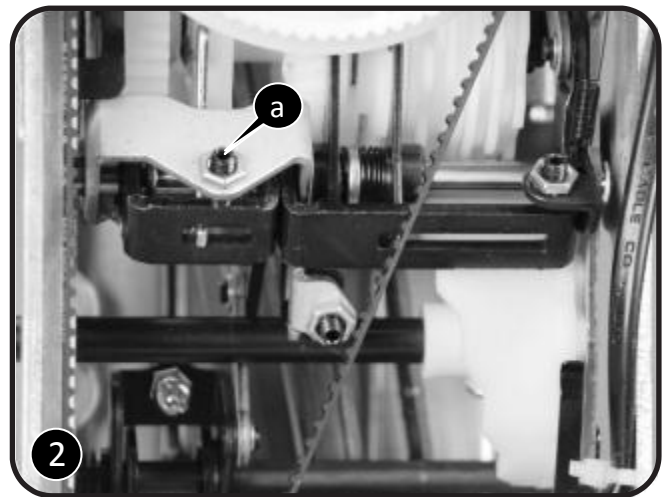
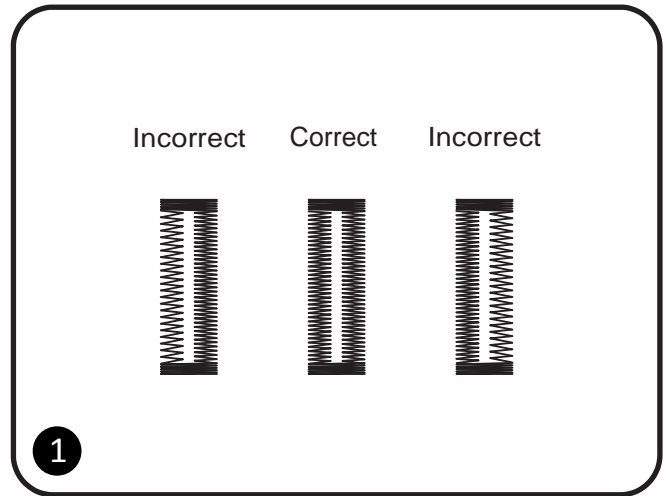
Clockwise = weak



5-25 Buttonhole upper and lower stitching problem

- 1) Remove the back cover, front cover.
- 2) Set the pattern selector dial to "  " (for 5 series).
- 3) Set the pattern selector dial to "  " (for 5 series).
- 4) Set the stitch length dial at "0.5" to "1".
- 5) While buttonhole upper or lower stitching, remain the same distance tacking without delivering cloth. (1)

If cloth delivered forward, adjust screw (a, b) clockwise. (2, 3)

If cloth delivered backward, adjust screw (a, b) counterclockwise. (2, 3)

- 6) Re-check after adjustment by above step 4.

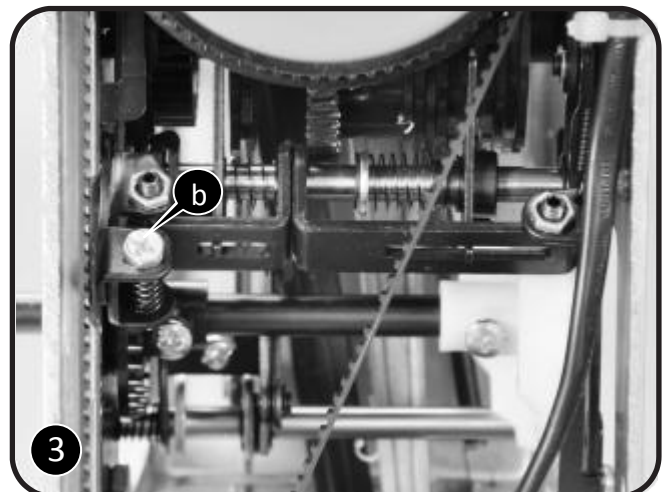
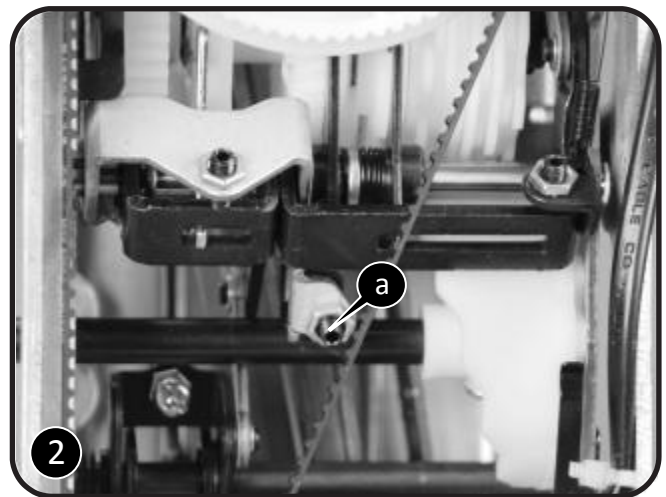
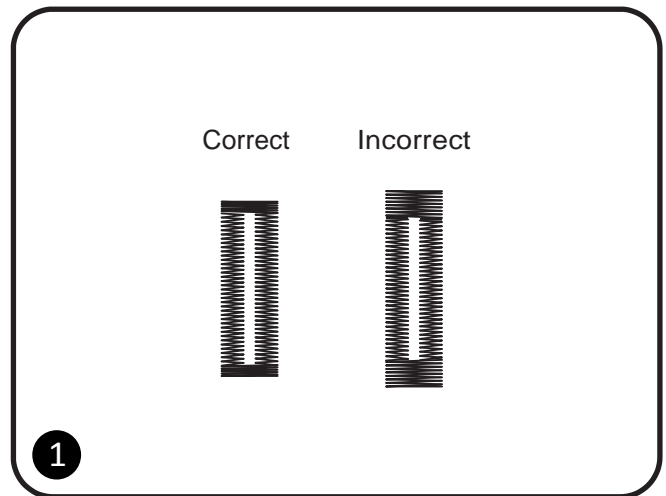

5-26 Bobbin winding problem

- 1) Place empty bobbin on spindle and push it to the right.
- 2) Put the thread into the spool rod, and put the spool rod cover on it.
- 3) Lead thread from spool to back side of thread guide (A) by following the indication.
- 4) Wind thread clockwise around bobbin winder tension disc. (1)
- 5) Turn on the power switch and step on the foot controller to run the machine.
- 6) Observe the shape of bobbin winding:

When the lower part of bobbin winding is thicker, turn the screw (a) of threader guide counter-clockwise. (2)

When the upper part of bobbin is thicker, turn the screw (a) of threader guide clockwise.

- 7) Observe the intensity:

If bobbin winding is not 80 percent full, adjust by turning the screw (b) of bobbin winder bracket shaft clockwise. (3)

If bobbin is over 80 percent full, adjust by turning the screw (b) of bobbin winder bracket shaft counter-clockwise.

- 8) Bobbin should be 80 percent full and evenly filled after adjustment.
- 9) Push bobbin to left after adjustment before sewing.

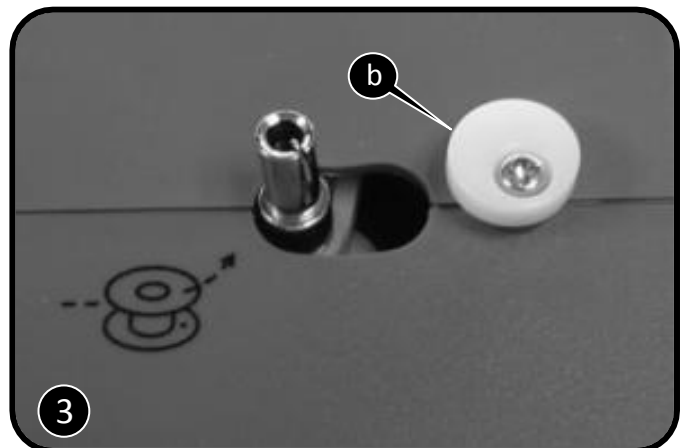
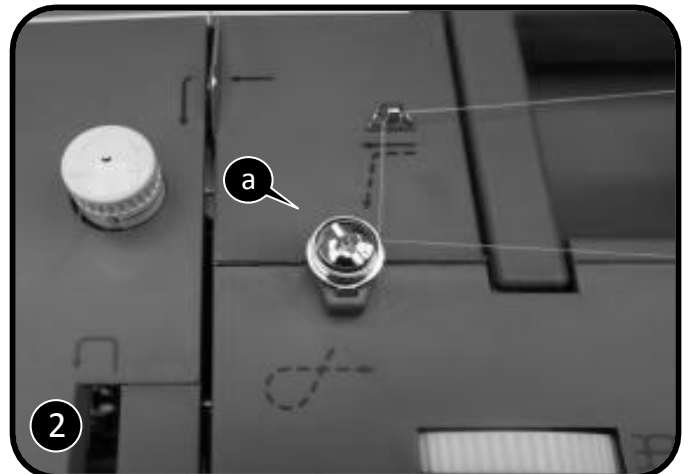

Voltage : 230V

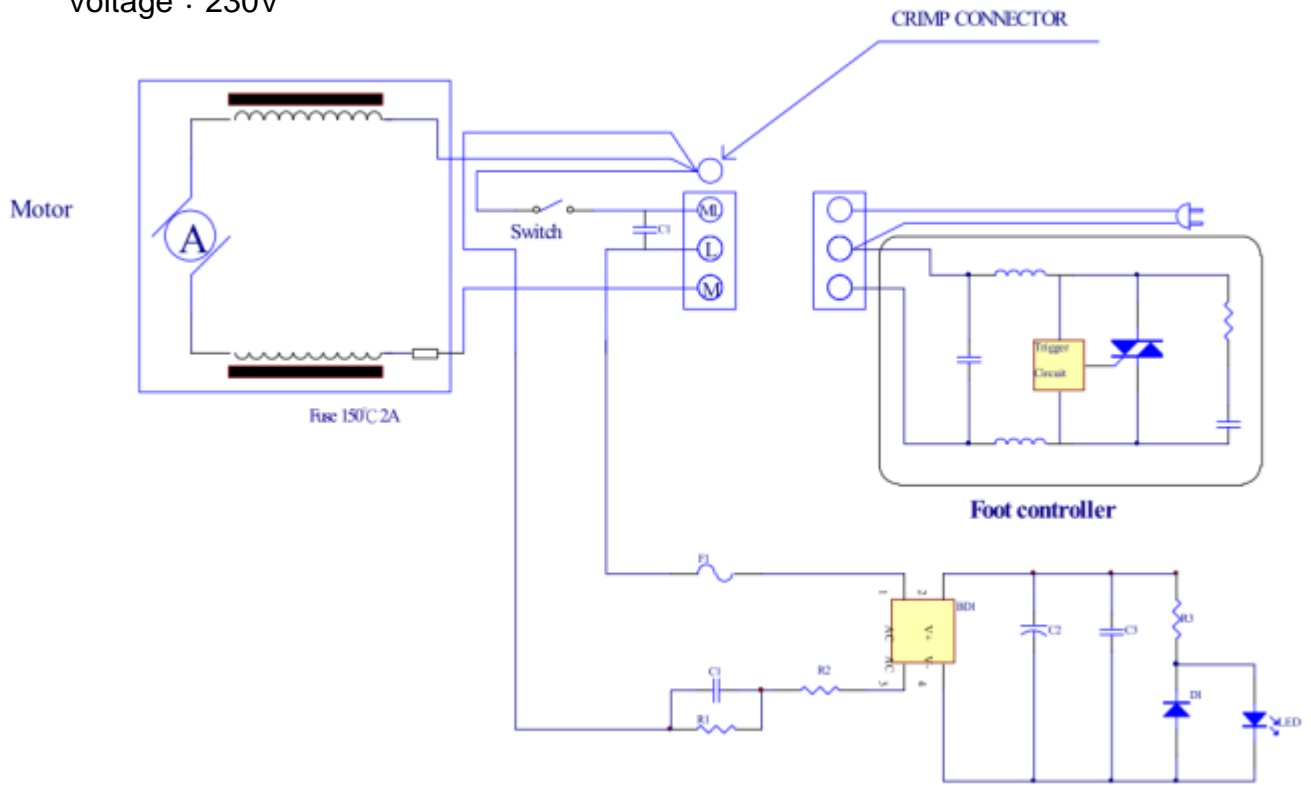

Voltage : 120V

