

Operation Manual

Sewing and Embroidery Machine

Product Code: 882-W73



Be sure to read this document before using the machine.
We recommend that you keep this document nearby for future reference. The latest manuals are available at
Brother Support website (<https://s.brother/cmead/>).

INTRODUCTION

Thank you for purchasing this machine. Before using this machine, carefully read the "IMPORTANT SAFETY INSTRUCTIONS", and then study this manual for the correct operation of the various functions. In addition, after you have finished reading this manual, store it where it can quickly be accessed for future reference.

IMPORTANT SAFETY INSTRUCTIONS

Please read these safety instructions before attempting to use the machine.

DANGER

- To reduce the risk of electric shock

1 Always unplug the machine from the electrical outlet immediately after using, cleaning, making any user servicing adjustments mentioned in this manual, or if you are leaving the machine unattended.

WARNING

- To reduce the risk of burns, fire, electrical shock, or injury to persons.

2 Always unplug the machine from the electrical outlet, or when making any adjustments mentioned in the instruction manual.

- To unplug the machine, switch the machine to the symbol "O" position to turn it off, then grasp the plug and pull it out of the electrical outlet. Do not pull on the cord.
- Plug the machine directly into the electrical outlet. Do not use an extension cord.
- Always unplug your machine if there is a power failure.

3 Electrical Hazards:

- This machine should be connected to an AC power source within the range indicated on the rating label. Do not connect it to a DC power source or inverter. If you are not sure what kind of power source you have, contact a qualified electrician.
- This machine is approved for use in the country of purchase only.

4 Never operate this machine if it has a damaged cord or plug, if it is not working properly, has been dropped or damaged, or water is spilled on the unit. Return the machine to the nearest authorized Brother dealer for examination, repair, electrical or mechanical adjustment.

- While the machine is stored or in use if you notice anything unusual, such as an odor, heat, discoloration or deformation, stop using the machine immediately and unplug the power cord.
- When transporting the machine, be sure to carry it by its handle. Lifting the machine by any other part may damage the machine or result in the machine falling, which could cause injuries.
- When lifting the machine, be careful not to make any sudden or careless movements, which may cause a personal injury.

5 Always keep your work area clear:

- Never operate the machine with any air openings blocked. Keep ventilation openings of the machine and the foot controller free from the build up of lint, dust, and loose cloth.
- Do not store objects on the foot controller.
- Never drop or insert foreign object into any opening.
- Do not operate where aerosol (spray) products are being used or where oxygen is being administered.
- Do not use the machine near a heat source, such as a stove or iron; otherwise, the machine, power cord or garment being sewn may ignite, resulting in fire or an electric shock.
- Do not place this machine on an unstable surface, such as an unsteady or slanted table, otherwise the machine may fall, resulting in injuries.

6 Special care is required when sewing:

- Always pay close attention to the needle. Do not use bent or damaged needles.
- Keep fingers away from all moving parts. Special care is required around the machine needle.
- Switch the machine to the symbol "O" position to turn it off when making any adjustments in the needle area.
- Do not use a damaged or incorrect needle plate, as it could cause the needle to break.
- Do not push or pull the fabric when sewing, and follow careful instruction when free motion stitching so that you do not deflect the needle and cause it to break.

7 This machine is not a toy:

- Your close attention is necessary when the machine is used by or near children.
- This product contains small parts. Keep the product out of the reach of children to prevent accidental ingestion of small parts.
- The plastic bag that this machine was supplied in should be kept out of the reach of children or disposed of. Never allow children to play with the bag due to the danger of suffocation.
- Do not use the seam ripper in any other way than how it is intended.
- Do not use outdoors.

8 For a longer service life:

- When using and storing this machine, avoid direct sunlight and high humidity locations. Do not use or store the machine near a space heater, iron, halogen lamp, or other hot objects.
- Do not use cleansers or organic solvents, such as thinner, petroleum ether or alcohol, to clean the machine. Otherwise, the finish may peel off or become scratched.
- Always consult the Operation Manual when replacing or installing any assemblies, the presser feet, needle, or other parts to assure correct installation.

9 For repair or adjustment:

- If the light unit is damaged, it must be replaced by an authorized Brother dealer.
- In the event a malfunction occurs or adjustment is required, first follow the troubleshooting table in the back of the Operation Manual to inspect and adjust the machine yourself. If the problem persists, please consult your local authorized Brother dealer.

Use this machine only for its intended use as described in the manual.

Use accessories recommended by the manufacturer as contained in this manual.

The contents of this manual and specifications of this product are subject to change without notice.

For additional product information and updates, visit our website at www.brother.com

SAVE THESE INSTRUCTIONS

This machine is intended for household use.

FOR USERS IN COUNTRIES EXCEPT EUROPEAN COUNTRIES

This appliance is not intended for use by persons (including children) with reduced physical, sensory or mental capabilities, or lack of experience and knowledge, unless they have been given supervision or instruction concerning use of the appliance by a person responsible for their safety. Children should be supervised to ensure that they do not play with the appliance.

FOR USERS IN EUROPEAN COUNTRIES

This appliance can be used by children aged from 8 years and above and persons with reduced physical, sensory or mental capabilities or lack of experience and knowledge if they have been given supervision or instruction concerning use of the appliance in a safe way and understand the hazards involved. Children shall not play with the appliance. Cleaning and user maintenance shall not be made by children without supervision.

FOR USERS IN THE UK, EIRE, MALTA AND CYPRUS ONLY

IMPORTANT

- In the event of replacing the plug fuse, use a fuse approved by ASTA to BS 1362, i.e. carrying the  mark, rating as marked on plug.
- Always replace the fuse cover. Never use plugs with the fuse cover omitted.
- If the available electrical outlet is not suitable for the plug supplied with this equipment, you should contact your authorized Brother dealer to obtain the correct lead.

Federal Communications Commission (FCC) Supplier's Declaration of Conformity (For U.S.A. Only)

Responsible Party: Brother International Corporation
200 Crossing Boulevard
P.O. Box 6911
Bridgewater, NJ 08807-0911
USA
TEL : (908) 704-1700

declares that the product

Product Name: Brother Sewing Machine
Model Number: XJ2

This device complies with Part 15 of the FCC Rules. Operation is subject to the following two conditions: (1) this device may not cause harmful interference, and (2) this device must accept any interference received, including interference that may cause undesired operation.

This equipment has been tested and found to comply with the limits for a Class B digital device, pursuant to Part 15 of the FCC Rules. These limits are designed to provide reasonable protection against harmful interference in a residential installation. This equipment generates, uses, and can radiate radio frequency energy and, if not installed and used in accordance with the instructions, may cause harmful interference to radio communications. However, there is no guarantee that interference will not occur in a particular installation. If this equipment does cause harmful interference to radio or television reception, which can be determined by turning the equipment off and on, the user is

encouraged to try to correct the interference by one or more of the following measures:

- Reorient or relocate the receiving antenna.
- Increase the separation between the equipment and receiver.
- Connect the equipment into an outlet on a circuit different from that to which the receiver is connected.
- Consult the authorized Brother dealer or an experienced radio/TV technician for help.
- This transmitter must not be co-located or operated in conjunction with any other antenna or transmitter.

Important

Changes or modifications not expressly approved by Brother Industries, Ltd. could void the user's authority to operate the equipment.

This equipment complies with FCC/IC radiation exposure limits set forth for an uncontrolled environment and meets the FCC radio frequency (RF) Exposure Guidelines and RSS-102 of the IC radio frequency (RF) Exposure rules. This equipment should be installed and operated keeping the radiator at least 20cm or more away from person's body.

For Users in Canada

This device complies with Industry Canada's licence-exempt RSSs. Operation is subject to the following two conditions:

- (1) This device may not cause interference; and
- (2) This device must accept any interference, including interference that may cause undesired operation of the device.

This equipment complies with FCC/IC radiation exposure limits set forth for an uncontrolled environment and meets the FCC radio frequency (RF) Exposure Guidelines and RSS-102 of the IC radio frequency (RF) Exposure rules. This equipment should be installed and operated keeping the radiator at least 20cm or more away from person's body.

For Users in Mexico

The operation of this equipment is subject to the following two conditions:

- (1) it is possible that this equipment or device may not cause harmful interference, and
- (2) this equipment or device must accept any interference, including interference that may cause undesired operation.

Para usuarios en México

La operación de este equipo está sujeta a las siguientes dos condiciones:

- (1) es posible que este equipo o dispositivo no cause interferencias perjudiciales y
- (2) este equipo o dispositivo debe aceptar cualquier interferencia, incluyendo la que pueda causar su operación no deseada.

Declaration of Conformity (Europe and Turkey only)

We, Brother Industries, Ltd. 15-1 Naeshiro-cho, Mizuho-ku, Nagoya 467-8561 Japan declare that this product is in conformity with the essential requirements of all relevant directives and regulations applied within the European Community.

The Declaration of Conformity (DoC) can be downloaded from Brother Support website. Visit support.brother.com

Declaration of Conformity for RE Directive 2014/53/ EU (Europe and Turkey only) (Applicable to models with radio interfaces)

We, Brother Industries, Ltd. 15-1 Naeshiro-cho, Mizuho-ku, Nagoya 467-8561 Japan declare that these products are in conformity with the provisions of the RE Directive 2014/53/EU.

The Declaration of Conformity (DoC) can be downloaded from Brother Support website. Visit support.brother.com

Wireless LAN (Models with Wireless LAN function only)

This machine supports wireless interface.

Frequency band(s): 2400-2483.5 MHz

Maximum radio-frequency power transmitted in the frequency band(s): Less than 20 dBm(e.i.r.p)

UK Declaration of Conformity (Great Britain only)

We, Brother Industries, Ltd. 15-1 Naeshiro-cho, Mizuho-ku, Nagoya 467-8561 Japan declare that these products are in conformity with the relevant UK legislation.

The Declaration of Conformity (DoC) can be downloaded from Brother Support website. Visit support.brother.com

UK Declaration of Conformity for Radio Equipment Regulation 2017

(Great Britain only) (Applicable to models with radio interfaces)

We, Brother Industries, Ltd. 15-1 Naeshiro-cho, Mizuho-ku, Nagoya 467-8561 Japan declare that these products are in conformity with the provisions of the Radio Equipment Regulation 2017.

The Declaration of Conformity (DoC) can be downloaded from Brother Support website. Visit support.brother.com

For Users in Norway

This subsection does not apply for the geographical area within a radius of 20 km from the centre of Ny-Alesund on Svalbard.

Dette underavsnittet gjelder ikke for det geografiske området innenfor en radius av 20 km fra sentrum av Ny-Ålesund på Svalbard.

Laser Notices (For U.S.A. only)

Laser Safety

This sewing machine is certified as a Class 1 laser product under the U.S. Department of Health and Human Services (DHHS) Radiation Performance Standard according to the Radiation Control for Health and Safety Act of 1968. This means that the sewing machine does not produce hazardous laser radiation.

IEC 60825-1 Specification

This machine is a Class 1 laser product as defined in IEC 60825-1:2007 and IEC 60825-1:2014 specifications.

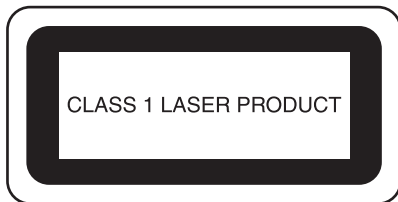

The laser beam emitted by the laser unit installed in this machine is restricted to an output at a safe level. However, the machine contains 6-milliwatt, 630-640 nanometer wavelength, 6-12 degree at parallel divergence angle, 28-40 degree at perpendicular divergence angle, InGaAlP laser diodes. Therefore, eye damage may result from disassembling or altering this machine.

Safety precautions have been designed to prevent any possible laser beam exposure to the operator.

FDA Regulations

U.S. Food and Drug Administration (FDA) has implemented regulations for laser products manufactured on and after August 2, 1976. Compliance is mandatory for products marketed in the United States. The label shown on the back of the sewing machine indicates compliance with the FDA regulations and must be attached to laser products marketed in the United States.

Brother Industries, Ltd.
15-1, Naeshiro-cho, Mizuho-ku, Nagoya 467-8561,
JAPAN

This product complies with FDA performance standards for laser products except for conformance with IEC 60825-1 Ed. 3., as described in Laser Notice No. 56, dated May 8, 2019.

⚠ CAUTION

- Use of controls, adjustments or the performance of procedures other than those specified in this manual may result in hazardous radiation exposure.

Laser Notices (For European countries)

EN 60825-1:2014+A11:2021 and EN 50689:2021 Specification

This machine is Class 1 consumer laser product in EN 60825-1:2014+A11:2021 and EN 50689:2021 specifications. This laser indicates the needle drop point.



Laser Notices (For countries except U.S.A. and European countries)

IEC 60825-1 Specification

This machine is a Class 1 laser product as defined in IEC 60825-1:2007 and IEC 60825-1:2014 specifications.

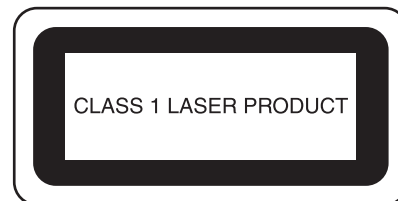

For countries except U.S.A.

The laser beam emitted by the laser unit installed in this machine is restricted to an output at a safe level. However, the machine contains 6-milliwatt, 630-640 nanometer wavelength, 6-12 degree at parallel divergence angle, 28-40 degree at perpendicular divergence angle, InGaAlP laser diodes. Therefore, eye damage may result from disassembling or altering this machine. Safety precautions have been designed to prevent any possible laser beam exposure to the operator.

⚠ CAUTION

- This sewing machine has a Class 3B Laser Diode in the Laser Unit. The Laser Unit should not be opened under any circumstances.
- Use of controls, adjustments or the performance of procedures other than those specified in this manual may result in hazardous radiation exposure.

TRADEMARKS

WPA™ and WPA2™ are trademarks of Wi-Fi Alliance®.

Any trade names and product names of companies appearing on Brother products, related documents and any other materials are all trademarks or registered trademarks of those respective companies.

COPYRIGHT AND LICENSE

This product includes software developed by the following vendor: ©2008 Devicescape Software, Inc.

OPEN SOURCE LICENSING REMARKS

This product includes open-source software. To see the open source licensing remarks, please go to the manual download section on your model's home page of Brother Support website at <https://s.brother/cpeae/>.

PRECAUTION FOR WIRELESS CONNECTION

Make sure you use a router or firewall when connecting your machine to the Internet to protect it against unauthorized access from the Internet.

CONTENTS

Chapter 1 GETTING READY	9	Chapter 3 VARIOUS STITCHES	67	1
NAMES OF MACHINE PARTS	9	UTILITY STITCHES	67	2
INCLUDED ACCESSORIES	11	Straight Stitches	67	3
Using the Multi-Purpose Screwdriver (Included with Some Models).....	12	Zigzag Stitches	71	4
Using the Spool Stand (Included with Some Models)	12	Overcasting.....	72	5
TURNING THE MACHINE ON/OFF	14	Quilting.....	73	6
LCD SCREEN	16	Blind Hem Stitches	79	7
Using the Machine Settings Key	20	Shell Tuck Stitches	81	
Using the Machine Help	24	Scallop Stitches	81	
Using the Stitch Pattern Explanation Function	26	Smocking Stitches	81	
WIRELESS NETWORK CONNECTION FUNCTIONS	27	Fagoting	82	
Operations Available with a Wireless Network Connection ...	27	Attaching Tape or Elastic	82	
Enabling a Wireless Network Connection	28	One-Step Buttonholes	83	
Using the Wizard to Set Up the Wireless Network Connection	28	Four-Step Buttonholes	85	
CONNECTING THE ACCESSORY TO THE MACHINE	30	Bar Tacks	88	
Using a USB Mouse	30	Button Sewing.....	89	
WINDING/INSTALLING THE BOBBIN	30	Eyelet	90	
Winding the Bobbin.....	30	Multi-directional Sewing (Straight Stitch and Zigzag Stitch) ...	90	
Setting the Bobbin.....	34	Zipper Insertion	91	
Pulling Up the Bobbin Thread.....	35	Changing the Start and End Angles of the Stitch Pattern (Stitch Tapering Function)	93	
UPPER THREADING	36	MAKING ADJUSTMENTS	95	
Upper Threading.....	36	MAKING STEP STITCH PATTERNS (FOR 7MM SATIN STITCH PATTERNS ONLY)	96	
Using the Twin Needle Mode	39	USING THE MEMORY FUNCTION	97	
Using the Spool Stand.....	41	Saving Stitch Patterns	97	
CHANGING THE NEEDLE	42	Retrieving Stitch Patterns	98	
FABRIC/THREAD/NEEDLE COMBINATIONS	44	MY CUSTOM STITCH	99	
CHANGING THE PRESSER FOOT	45	Retrieving Saved Stitch Patterns	101	
Replacing the Presser Foot	45	Chapter 4 BASIC EMBROIDERY	103	
Attaching the Presser Foot with the Included Adapter	45	BEFORE EMBROIDERING	103	
Using the Compact Dual Feed Foot	46	Embroidery Step by Step.....	103	
Chapter 2 SEWING BASICS	49	Attaching Embroidery Foot “W+” with LED Pointer	103	
SEWING	49	About the Embroidery Unit.....	104	
Stitch Types	49	SELECTING PATTERNS	105	
Basic Sewing.....	49	Selecting Embroidery Patterns	106	
Using Advanced Multi-Function Foot Controller (Included with Some Models).....	51	Selecting Character Patterns	107	
Combining Stitch Patterns	53	Selecting Frame Patterns.....	109	
Sewing Reverse Stitches/Reinforcement Stitches.....	55	Combining Patterns	109	
Automatic Reverse/Reinforcement Stitching	55	EDITING PATTERNS	111	
Automatic Presser Foot Lowering Function and Thread Cutting Function	57	Previewing the Pattern.....	113	
STITCH SETTINGS	57	Changing the Size and the Density of the Pattern	114	
Setting the Stitch Width/Stitch Length/“L/R Shift”	57	Creating Repeated Patterns.....	114	
Setting the Thread Tension	58	Embroidering the Pattern Repeatedly	118	
Saving Your Stitch Settings	59	Deselect Region Setting (No Sew Setting)	119	
USEFUL FUNCTIONS	60	EDITING COLORS	120	
Automatic Thread Cutting	60	Changing the Thread Color	120	
Adjusting the Needle Drop Point with the Guideline Marker ...	60	Finding New Color Schemes with the Color Shuffling Function	121	
Pivoting	61	Thread Color Sorting	123	
Using the Knee Lifter.....	62	VIEWING THE EMBROIDERY SCREEN	124	
Automatic Fabric Sensor System (Automatic Presser Foot Pressure)	62	PREPARING THE FABRIC	126	
Needle Position - Stitch Placement	62	Attaching Iron-on Stabilizers (Backing) to the Fabric.....	126	
Using the Straight Stitch Needle Plate and the Straight Stitch Foot.....	63	Hooping the Fabric in the Embroidery Frame	127	
USEFUL SEWING TIPS	64	ATTACHING THE EMBROIDERY FRAME	129	
Sewing Tips	64	CONFIRMING THE PATTERN POSITION	130	
Sewing Various Fabrics	65	Checking the Needle Drop Point with the Embroidery Foot “W+” with LED Pointer	130	
Sewing Decorative Stitch Patterns	66	Displaying a Background Image	131	
		Checking the Pattern Position	132	
		THE 2-POINT EMBROIDERY POSITIONING FUNCTION	133	
		EMBROIDERING A PATTERN	137	
		Embroidering Attractive Finishes	137	
		Embroidering Patterns	138	

Using Appliqués 139

ADJUSTMENTS DURING THE EMBROIDERY PROCESS..... 141

If the Thread Breaks or the Bobbin Runs out of Thread During Embroidering..... 141

Resuming Embroidery after Turning off the Power 141

Chapter 5 ADVANCED EMBROIDERY 143

VARIOUS EMBROIDERING FUNCTIONS..... 143

Basting Embroidery 143

Creating an Appliqué Piece 144

MAKING EMBROIDERY ADJUSTMENTS 147

Adjusting Thread Tension 147

Adjusting the Alternate Bobbin Case (with No Color on the Screw) 148

Using the Automatic Thread Cutting Function (End Color Trim)..... 149

Using the Thread Trimming Function (Jump Stitch Trim) 150

Adjusting the Embroidery Speed..... 150

Changing the Thread Color Display..... 151

Aligning the Pattern and the Needle 151

Embroidering Linked Characters..... 152

USING THE MEMORY FUNCTION..... 153

Saving Embroidery Patterns 153

Retrieving Embroidery Patterns..... 154

EMBROIDERY APPLICATIONS..... 155

Using a Frame Pattern To Make an Appliqué..... 155

Embroidering Couching Patterns 156

Creating Stippling, Echo Quilting, or Decorative Fill Patterns around a Design..... 159

Embroidering Split Embroidery Patterns..... 160

Chapter 6 MY DESIGN CENTER 161

ABOUT MY DESIGN CENTER 161

PATTERN DRAWING SCREEN 161

Before Creating Designs 163

Drawing Lines 163

Drawing Regions..... 164

Using the Stamp Key 165

Using the Erase Key..... 166

Using the Select Key..... 166

STITCH SETTINGS SCREEN 167

Specifying Individual Stitch Settings 167

Specifying Global Stitch Settings 168

Loading the Background Image 169

LINE CONVERSION 170

Create a Pattern with Line Conversion 170

ILLUSTRATION CONVERSION..... 172

Create a Pattern with Illustration Conversion 172

STIPPLING..... 174

Basic Stippling with My Design Center..... 174

Decorative Stitching around a Pattern in Embroidery (a Quilting Function) 176

MY STITCH MONITOR APP..... 178

MY DESIGN SNAP APP 179

ARTSPIRA APP COMPATIBLE..... 180

Chapter 7 APPENDIX 181

CARE AND MAINTENANCE..... 181

Cleaning the LCD 181

Cleaning the machine surface 181

Restrictions on Oiling..... 181

Precautions on Storing the Machine 181

Cleaning the Race 181

Cleaning the Cutter in the Bobbin Case Area 182

BEFORE LENDING OR DISPOSING OF THE PRODUCT..... 183

ADJUSTING THE SCREEN..... 183

Touch Panel is Malfunctioning 183

TROUBLESHOOTING 184

Frequent Troubleshooting Topics..... 184

Upper Thread is Too Tight 184

Tangled Thread on Wrong Side of Fabric..... 184

Incorrect Thread Tension 185

Fabric is Caught in the Machine and Cannot Be Removed... 185

If the Thread Becomes Tangled Under the Bobbin

Winder Seat..... 186

List of Symptoms..... 187

ERROR MESSAGES..... 192

SPECIFICATIONS..... 194

UPDATING YOUR MACHINE'S SOFTWARE... 196

Update Procedure Using USB Media 196

Update Procedure Using Wireless LAN Connection 196

STITCH SETTING CHART 197

INDEX..... 204

Chapter 1 GETTING READY

Note

- Be sure to install the latest software. Refer to “UPDATING YOUR MACHINE’S SOFTWARE” on page 196.

NAMES OF MACHINE PARTS

■ Main Parts

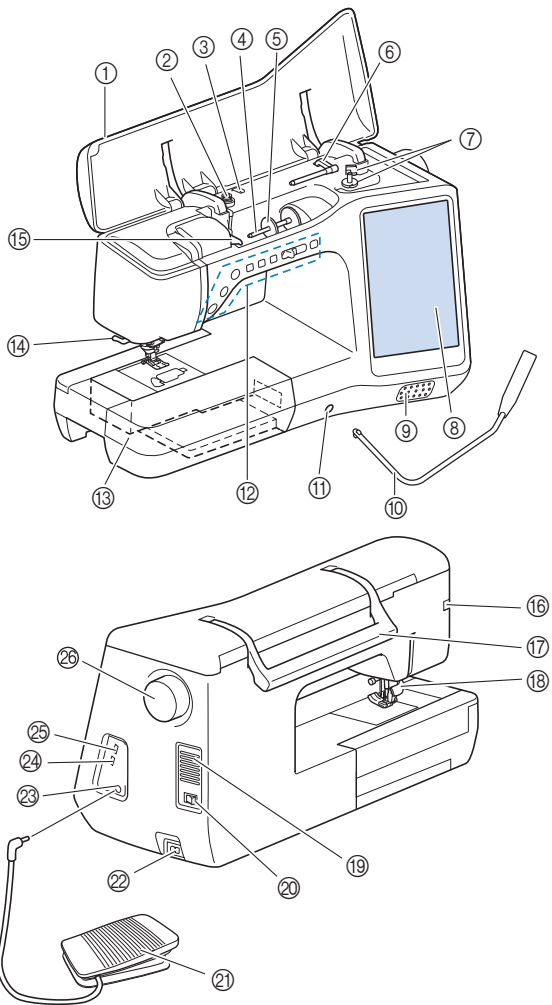

- ① Top cover
- ② Pretension disk (page 32)
- ③ Thread guide for bobbin winding (page 31)
- ④ Spool pin (page 37)
- ⑤ Spool cap (page 30)
- ⑥ Supplemental spool pin (page 30)
- ⑦ Bobbin winder (page 30)
- ⑧ LCD (liquid crystal display) (page 16)
- ⑨ Speaker
- ⑩ Knee lifter (page 62)
- ⑪ Knee lifter slot (page 62)
- ⑫ Operation buttons and sewing speed controller (page 10)

- ⑬ Flat bed attachment with accessory compartment (page 11)
- ⑭ Thread cutter (page 38)
- ⑮ Thread guide plate (page 33)
- ⑯ Connector for the presser foot (page 46, page 104)
- ⑰ Handle
Carry the machine by its handle when transporting the machine.
- ⑱ Presser foot lever
You cannot use the presser foot lever after the presser foot has been raised using  (Presser foot lifter button).
- ⑲ Air vent
The air vent allows the air surrounding the motor to circulate. Do not cover the air vent while the machine is being used.
- ⑳ Main power switch (page 14)
- ㉑ Foot controller (page 51)
- ㉒ Power cord receptacle (page 14)
- ㉓ Foot controller jack (page 51)
- ㉔ USB port for mouse (page 30)
- ㉕ USB port
- ㉖ Handwheel
Turn the handwheel toward you (counterclockwise) to raise and lower the needle.

■ Needle and Presser Foot Section

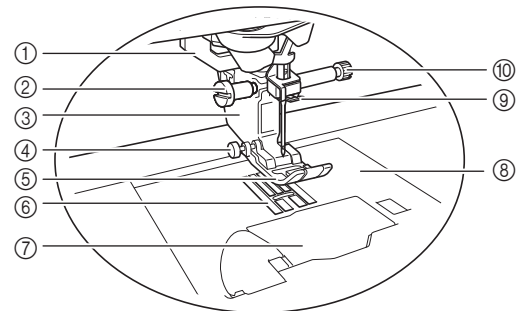

- ① Buttonhole lever (page 84)
- ② Presser foot holder screw (page 45, page 103)
- ③ Presser foot holder (page 45)
- ④ Presser foot locking pin (page 65)
- ⑤ Presser foot
The presser foot consistently applies pressure to the fabric as sewing takes place. Attach the appropriate presser foot for the selected stitch.
- ⑥ Feed dogs
The feed dogs feed the fabric in the sewing direction.
- ⑦ Bobbin cover (page 34)
- ⑧ Needle plate (page 68)
- ⑨ Needle bar thread guide (page 37)
- ⑩ Needle clamp screw (page 43)

Measurements on the needle plate and the bobbin cover (with mark)

The measurements on the bobbin cover and needle plate are references for stitch patterns with a left or middle (center) needle position.

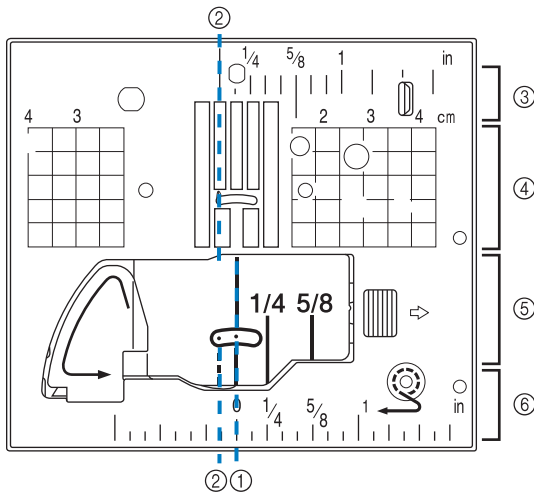

- ① For stitches with a middle (center) needle position
- ② For stitches with a left needle position
- ③ Left needle position on the needle plate <inch>
- ④ Left needle position on the needle plate <cm>
- ⑤ Middle (center) needle position on the bobbin cover (with mark) <inch>
- ⑥ Middle (center) needle position on the needle plate

Embroidery unit

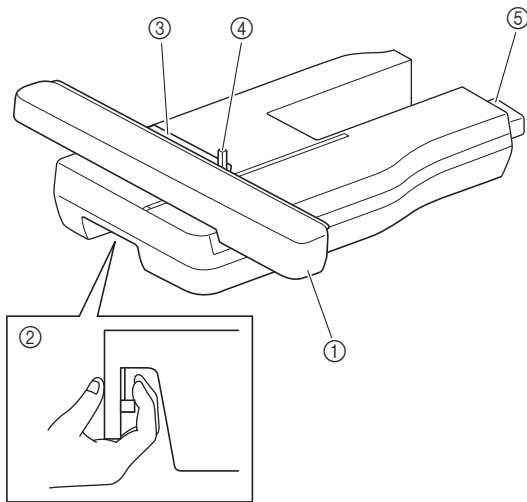





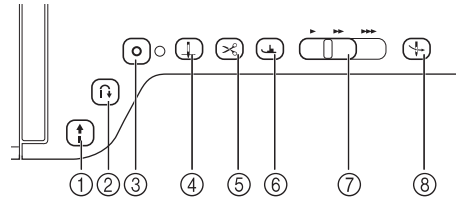

- ① **Carriage**
The carriage moves the embroidery frame automatically when embroidering.
- ② **Release lever (located under the embroidery unit)**
Press the release lever to remove the embroidery unit.
- ③ **Embroidery frame holder**
Insert the embroidery frame into the embroidery frame holder to hold the frame in place.
- ④ **Frame-securing lever**
Press the frame-securing lever down to secure the embroidery frame.
- ⑤ **Embroidery unit connection**
Insert the embroidery unit connection into the connection port when attaching the embroidery unit.

Operation Buttons



- ① **“Start/Stop” button** 
Press the “Start/Stop” button to start or stop sewing. The button changes color according to the machine’s operation mode.

Green: The machine is ready or is operating.
Red: The machine is not ready.
- ② **Reverse stitch button** 
Press the reverse button to sew reverse or reinforcement stitches depending on the selected stitch pattern. (page 55)
- ③ **Reinforcement stitch button** 
Press the reinforcement button to sew a single stitch repeatedly and tie-off. (page 55)
For character/decorative stitches, press this button to end with a full stitch instead of at a mid-point.
The LED beside the button automatically lights up while the stitch is being sewn and goes off when sewing is finished.
- ④ **Needle position button** 
Press the needle position button to raise or lower the needle position. Pressing the button twice sews a single stitch.
- ⑤ **Thread cutter button** 
Press the thread cutter button after sewing to automatically trim the excess thread.
- ⑥ **Presser foot lifter button** 
Press the presser foot lifter button to lower the presser foot and apply pressure to the fabric. Press this button again to raise the presser foot.
- ⑦ **Sewing Speed controller** 
Use the sewing speed controller to adjust the sewing speed. Move the slide to the left to sew at slower speeds. Move the slide to the right to sew at higher speeds.
- ⑧ **Automatic threading button** 
Use the automatic threading button to automatically thread the needle.

INCLUDED ACCESSORIES

For included accessories of your machine, refer to the additional sheet "Included Accessories".

■ Using the Flat Bed Attachment

Pull the top of the flat bed attachment to open the accessory compartment.

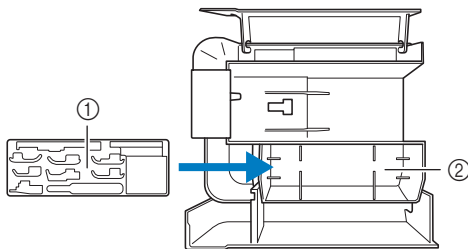
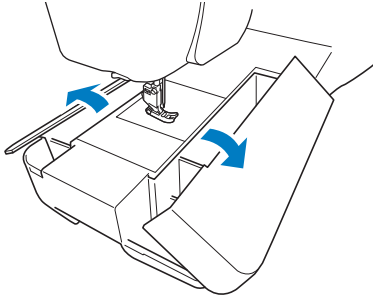

- ① Presser foot storage tray
- ② Presser foot storage space of the flat bed attachment

■ Using the Accessory Case (Included with Some Models)

□ Opening the accessory case

Fully slide the bar on each side of the accessory case to the unlocked position, and then lift off the lid to open the case.

The case can only be opened or locked correctly if both bars are slid in the same direction.

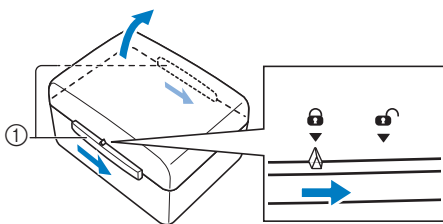

- ① Bars

□ Closing the accessory case

- 1 Fully slide the bar on each side of the accessory case lid to the unlocked position.

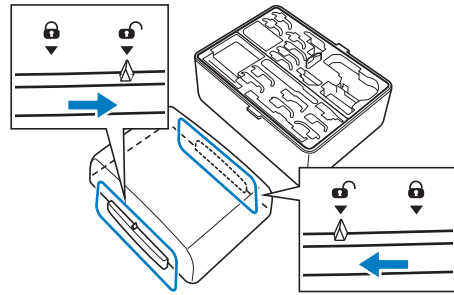

- 2 Place the lid on top of the case so that the notches in the lid align with the tabs on the case, and then slide the bar on each side back to the locked position.

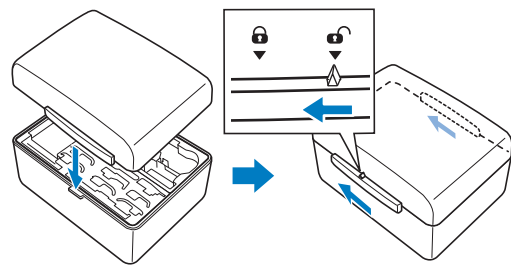

■ Storing Bobbin Clips

Bobbin clips can be stored inside of the accessory case cover.

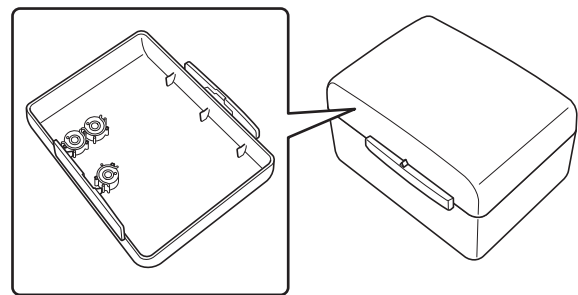

📌 Memo

- Placing bobbin clips on bobbins helps prevent the thread from unwinding from the bobbin. In addition, snapping bobbin clips together allows the bobbins to be conveniently stored and prevents them from rolling around if they are dropped.

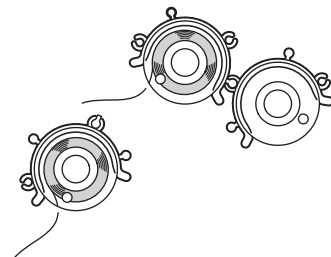

Using the Multi-Purpose Screwdriver (Included with Some Models)

Since the screwdriver can be changed to three different positions, it can be extremely useful for the various machine preparations. With this machine, position "1" and position "3" are used.

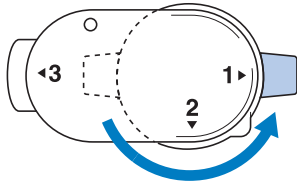

Position "1"	You can install/remove the presser foot holder, needle clamp screw or needle plate.
Position "3"	The multi-purpose screwdriver can be positioned over the screw on the embroidery frame to tighten the screw after hooping the fabric or when removing the fabric.

Using the Spool Stand (Included with Some Models)

The included spool stand is useful when using thread spools with a large diameter (cross-wound thread). The spool stand can hold two spools of thread.

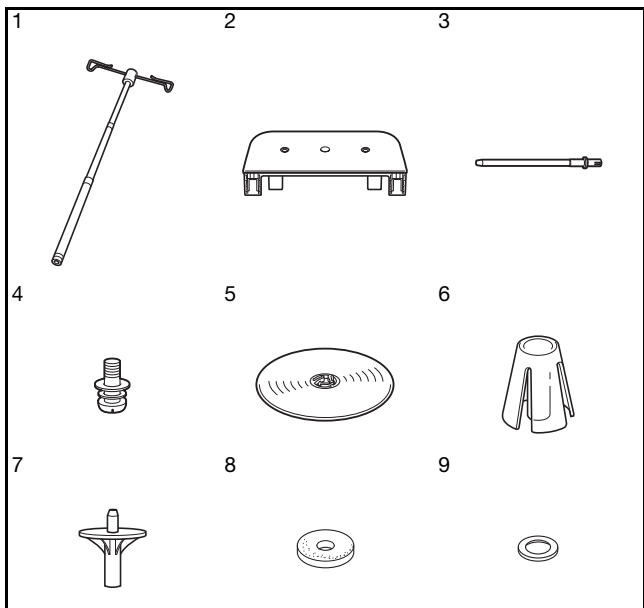

No.	Part Name
1	Telescopic thread guide
2	Spool support
3	Spool pin × 2
4	Screw and washer
5	Spool cap (XL) × 2
6	Spool holder × 2
7	Spool cap base × 2
8	Spool felt × 2
9	Ring × 4

IMPORTANT

- Do not lift the handle of the machine while the spool stand is installed.
- Do not push or pull the telescopic thread guide or spool pins with extreme force, otherwise damage may result.
- Do not place any object other than spools of thread on the spool support.
- Do not try to wind thread on the bobbin while sewing using the spool stand.

How to Assemble the Spool Stand

- 1 Fully extend the telescopic thread guide shaft, and then rotate the shaft until the two internal stoppers click into place.

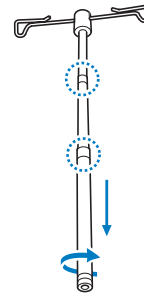

- 2 Insert the telescopic thread guide into the round hole at the center of the spool support, and then use a screwdriver to securely tighten the screw from the reverse side.

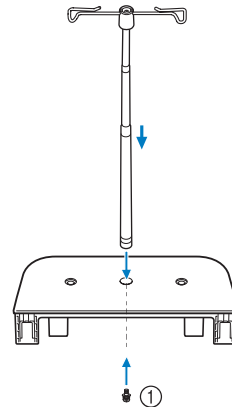

① Screw

Note

- Make sure that the stoppers on the telescopic thread guide shaft are firmly in place and that the thread guide openings are directly above the two holes for spool pins in the spool support. In addition, check that the shaft is securely tightened in the spool support.

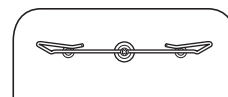

- 3** Firmly insert the two spool pins into the two holes in the spool support.

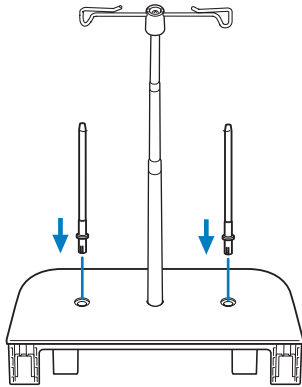

- 4** Open the upper cover of the machine, and then pull the upper cover up to remove it from the machine.

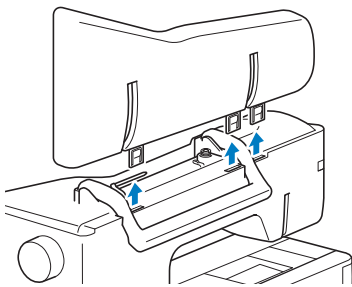

- 5** Insert the spool stand onto the notches of the machine.

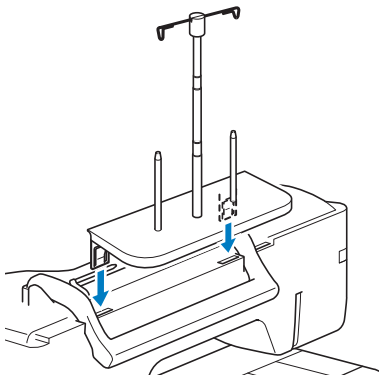

How To Remove

- 1** Pull the spool stand up to remove it from the machine.

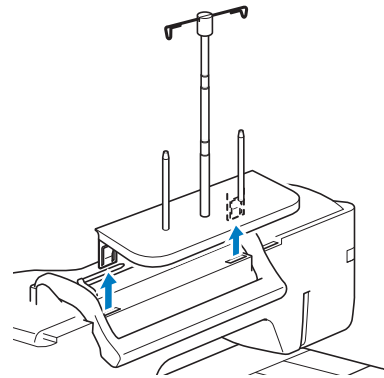

- 2** Attach the upper cover to the machine.

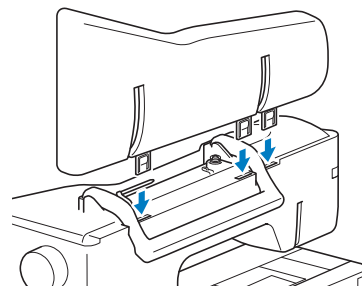

TURNING THE MACHINE ON/OFF

⚠ WARNING

- Use only regular household electricity for the power source. Using other power sources may result in fire, electric shock, or damage to the machine.
- Do not touch the plug with wet hands. Electric shock may result.
- Make sure that the plugs on the power cord are firmly inserted into the electrical outlet and the power cord receptacle on the machine. Otherwise, a fire or electric shock may result.
- Turn the main power to OFF and remove the plug in the following circumstances:
 - When you are away from the machine
 - After using the machine
 - When the power fails during use
 - When the machine does not operate correctly due to a bad connection or a disconnection
 - During electrical storms

⚠ CAUTION

- Use only the power cord included with this machine.
- Do not use extension cords or multi-plug adapters with many other appliances plugged in to them. Fire or electric shock may result.
- When unplugging the machine, always turn the main power to OFF first. Always grasp the plug to remove it from the outlet. Pulling on the cord may damage the cord, or lead to fire or electric shock.
- Do not allow the power cord to be cut, damaged, modified, forcefully bent, pulled, twisted, or bundled. Do not place heavy objects on the cord. Do not subject the cord to heat. These things may damage the cord, or cause fire or electric shock. If the cord or plug is damaged, take the machine to your authorized Brother dealer for repairs before continuing use.
- Unplug the power cord if the machine is not to be used for a long period of time. Otherwise, a fire may result.

- (For U.S.A only)
This appliance has a polarized plug (one blade wider than the other). To reduce the risk of electrical shock, this plug is intended to fit in a polarized electrical outlet only one way. If the plug does not fit fully in the electrical outlet, reverse the plug. If it still does not fit, contact a qualified electrician to install the proper electrical outlet. Do not modify the plug in any way.

- 1 Insert the power supply cord into the power cord receptacle, then insert the plug into a wall outlet.

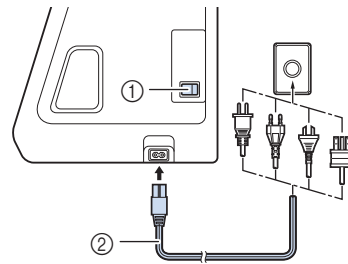

- ① Main power switch
- ② Power supply cord

- 2 Turn the main power switch to "I" to turn on the machine.

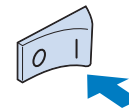

📖 Memo

- The light, LCD and the "Start/Stop" button light up when the machine is turned on. The machine will make a sound. This is not a malfunction.

- 3 When the machine is turned on, the opening movie is played. Touch anywhere on the screen.

- 4 Turn the main power switch to "O" to turn off the machine.

■ Setting Your Machine for the First Time

When you first turn on the machine, set the language and time/date to your language and local time/date.

- 1 Touch and to set your local language and then touch .

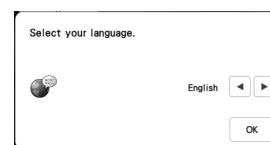

- 2 The message screen, confirming if you want to set time/date, appears. Touch .
- 3 Touch or to set time/date. And then touch .

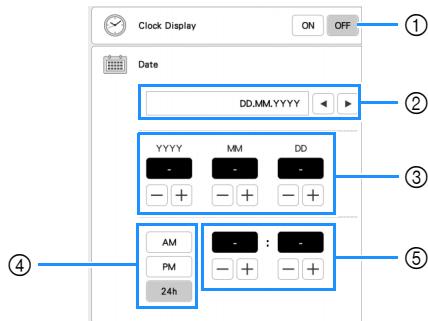

- 1 Select [ON] to display time/date on the screen.
 - 2 Touch or to select the date display format.
 - 3 Set the year (YYYY), month (MM) and date (DD).
 - 4 Select whether 24h or 12h setting will display.
 - 5 Set the current time.
- The clock starts from 0 second of the time you set.

Memo

- The time/date you set may be cleared, if you don't turn on the machine for an extended period of time.

- 4 The following message about a wireless LAN connection appears. To set up a connection, touch , and then refer to steps 3 through 6 in "Using the Wizard to Set Up the Wireless Network Connection" on page 28 to finish setting up a wireless LAN connection.

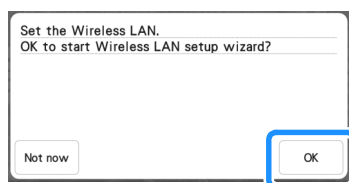

LCD SCREEN

Touch the LCD screen or a key with your finger or the included touch pen to select a machine function.

IMPORTANT





- Only touch the screen with your finger or the touch pen (stylus) included with the machine. Do not use a mechanical pencil, screwdriver or any other hard or sharp object. In addition, do not press the screen with extreme pressure. Otherwise the screen may be damaged.



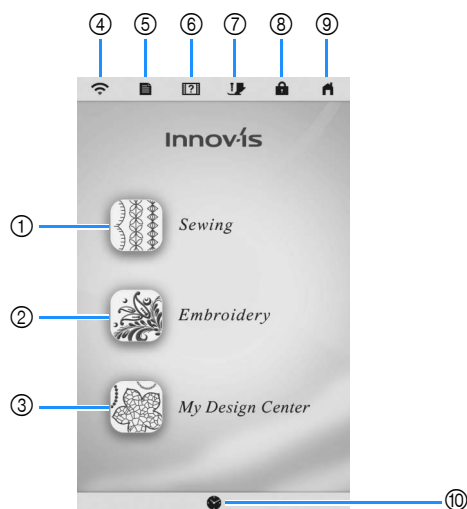



Note

- All or part of the screen may sometimes become darker or lighter due to changes in the surrounding temperature or other changes in the environment. This is not a sign of a malfunction. If the screen is difficult to read, adjust its brightness.

■ Home Page Screen



No.	Display	Explanation	Page
	Name		
①		Select a utility stitch or character/ decorative stitch pattern.	49
	Sewing key		
②		Select an embroidery pattern. Attach the embroidery unit.	105
	Embroidery key		
③		Create an original embroidery pattern.	161
	My Design Center key		
④		Shows the machine's signal strength. Touch this key to specify the wireless settings. If there is a new update file, the key appears as  .	22, 28
	Wireless LAN key		

No.	Display	Explanation	Page
	Name		
⑤		Change the needle stop position, adjust the pattern or screen, and change other machine settings.	20
	Machine settings key		
⑥		See explanations on how to use the machine. You can see the tutorial videos and also MP4 movie files that you have saved on USB media.	24
	Machine help key		
⑦		Touch this key before changing the needle, the presser foot, etc. This key locks all key and button functions to prevent operation of the machine.	34, 42, 45
	Presser foot/ Needle exchange key		
⑧		Lock the screen. When the screen is locked, you can still sew, but cannot change any of the screen functions. Touch this key again to unlock the screen.	—
	Screen lock key		
⑨		Return to the home page screen at any time and select a different category - [Sewing], [Embroidery] or [My Design Center].	—
	Home page screen key		
⑩		Set the time/date.	14
	Time/Date key		

Utility Stitch Screen

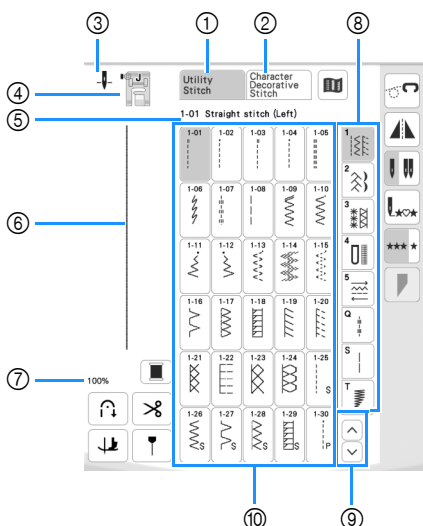

Character/Decorative Stitch Screen

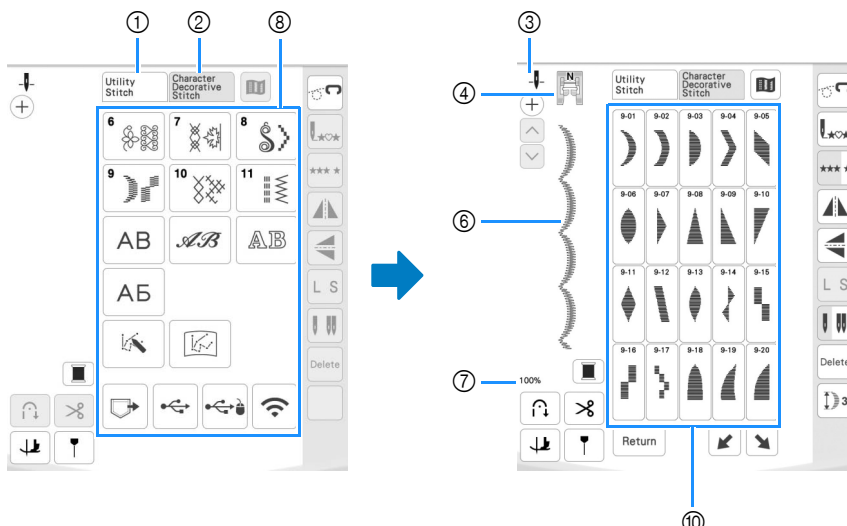

No.	Display	Name	Explanation	Page
①		Utility stitch key	Select a straight stitch, zigzag stitch, buttonhole, blind hem stitch, or other stitch (utility stitch) commonly used in garment making.	49
②		Character/Decorative stitch key	Select character or decorative stitch patterns.	49
③		Needle position setting	Shows single or twin needle mode setting, and the needle stop position. Single needle/down position Twin needle/down position Single needle/up position Twin needle/up position	39, 61
④		Presser foot	Shows the presser foot to be used. Attach the presser foot indicated here before sewing. * The symbols for certain presser feet, such as zipper foot "I", may not appear in the screen. * Advanced monogramming foot "N+" is displayed as "N" on the screen.	45
⑤	1-01 Straight stitch (Left)	Selected stitch display	Shows the name and code number of the selected stitch.	-
⑥		Stitch preview	Shows a preview of the selected stitch. When shown at 100%, the stitch appears in the screen at nearly its actual size.	-
⑦	100%	Stitch pattern display size	Shows the approximate size of the stitch pattern selected. 100%: Nearly the same size as the sewn stitch pattern 50%: 1/2 the size of the sewn stitch pattern 25%: 1/4 the size of the sewn stitch pattern	-
⑧	-	Category	Select the category of the stitch pattern you want to sew.	49
⑨		Page key	Touch or , to move the pages of stitch selection screen, one page at a time. You can scroll up and down the pages by touching the screen.	-
⑩		Stitch selection screen	Touch the key for the stitch pattern you want to sew.	-



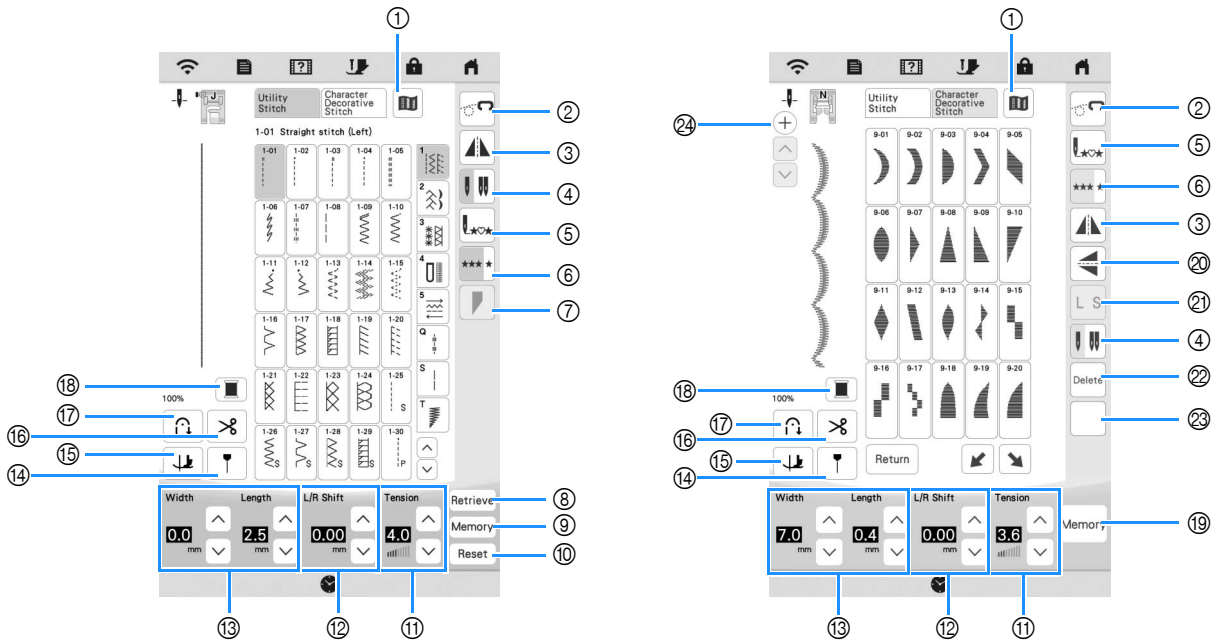



















■ Key Functions







Memo

- Some editing functions cannot be used with certain stitch patterns. Only the functions for the displayed keys are available when a stitch pattern is selected.
- The machine default setting is highlighted.



No.	Display	Name	Explanation	Page
①		Image key	Display an enlarged image of the selected stitch pattern. Touch to change the thread color in the image. To display the enlarged image, touch . To view any part of the image that extends out of the viewable display area, touch / / / .	-
②		Free motion mode key	Touch this key to enter free motion sewing mode. The presser foot is raised to an appropriate height and the feed dog is lowered for free motion quilting.	76
③		Horizontal mirror image key	Create a horizontal mirror image of the stitch pattern.	-
④		Needle mode selection key (single/double)	Touch this key to select twin needle mode. The sewing mode changes between single needle mode and twin needle mode each time you touch the key. • If the key is light gray after selecting the stitch, the selected stitch cannot be sewn in the twin needle mode.	39
⑤		Back to beginning key	When sewing is stopped, touch this key to return to the beginning of the stitch.	-
⑥		Single/Repeat sewing key	Select single stitches or continuous stitches. To finish a complete motif while sewing the stitch pattern continuously, you can touch this key while sewing. The machine will automatically stop when the motif is finished.	97
⑦		Stitch tapering key	Touch this key to change the start and end angles of the stitch pattern.	93
⑧	Retrieve	Retrieve key	Retrieve a saved stitch pattern.	59
⑨	Memory	Manual memory key	Change the stitch pattern settings (zigzag width and stitch length, thread tension, etc.), then save them by touching this key. Five sets of settings can be saved for a single stitch pattern.	59
⑩	Reset	Reset key	Return the saved settings for the selected stitch pattern to their defaults.	59
⑪		Thread tension key	Shows the automatic thread tension setting of the currently selected stitch pattern. You can use and to change the thread tension settings.	58

No.	Display	Name	Explanation	Page
⑫		"L/R Shift" key	Touch  to shift the stitch pattern to the right or touch  to shift the stitch pattern to the left. This feature is not available for all stitch patterns. Only those applicable will be shifted.	58
⑬		Stitch width and stitch length key	Shows the zigzag width and stitch length settings of the currently selected stitch pattern. You can use  and  to adjust the zigzag width and stitch length settings.	57
⑭		Guideline marker key	Display the guideline marker along the sewing line. The guideline marker makes it easier to align stitches with the fabric edge or other marker on the fabric.	60
⑮		Pivot key	Turn on/off the pivot function. When the pivot function is selected, stopping the machine lowers the needle and slightly raises the presser foot automatically. In addition, when sewing is restarted, the presser foot is automatically lowered.	61
⑯		Automatic thread cutting key	Turn on this function to set the machine to automatically sew reinforcement stitches (or reverse stitches, depending on the selected stitch pattern) at the beginning and end of stitching and to trim the threads at the end of stitching.	60
⑰		Automatic reverse/reinforcement stitch key	If you select this setting before sewing, the machine will automatically sew reinforcement stitches at the beginning and end of sewing (depending on the pattern, the machine may sew reverse stitches).	55
⑱		Thread color change key	Change the thread color in the image.	-
⑲		Memory key	Save stitch pattern combinations.	97
⑳		Vertical mirror image key	Create a vertical mirror image of the stitch pattern.	-
㉑		Size selection key	Select the size of the decorative stitch pattern or character stitch pattern (large, small).	-
㉒		Delete key	Delete the selected stitch pattern.	54
㉓	Some of the following keys will appear, depending on the selected stitch pattern.			
		Elongation key	When 7mm satin stitch patterns are selected, you can choose from 5 automatic length settings, without changing the stitch zigzag width or stitch length settings. 	-
		Thread density key	When the satin stitch patterns are selected, you can change the thread density of the stitch pattern.  : Low density  : High density	-
		Character spacing key	Change the spacing of character stitch patterns. The setting is applied to all entered characters.	-
㉔		Add stitch pattern key	Touch this key when you want to combine decorative stitch patterns and/or character stitch patterns.	54

Using the Machine Settings Key





Touch  to change the default machine settings (needle stop position, embroidery speed, opening display, etc.). To display the different settings screens, touch  for “Sewing settings”,  for “General settings”,  for “Embroidery settings” or  for “Wireless LAN settings”.

Memo

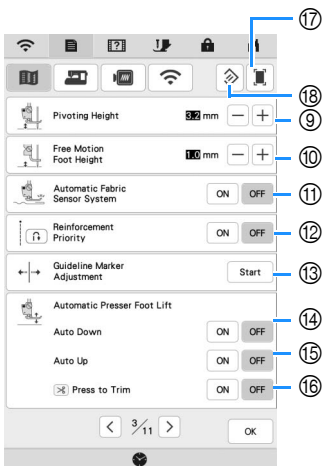
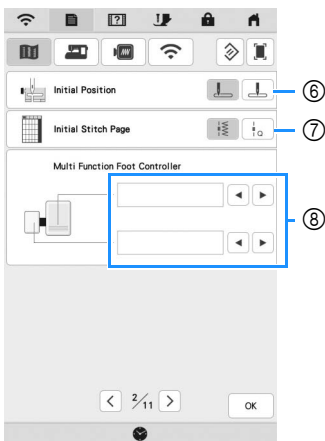
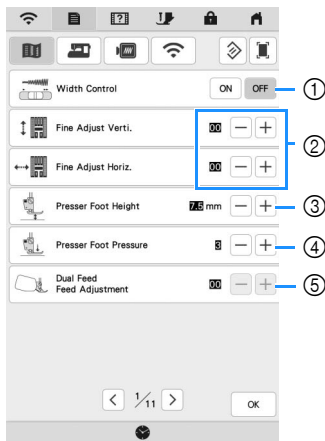
- Touch  or  to display a different settings screen.

■ Sewing Settings



- ① Select whether to use the sewing speed controller to determine the zigzag width (page 75). When a straight stitch is selected, the sewing speed controller can be used to change the needle position.
- ② Make adjustments to character or decorative stitch patterns (page 95).
- ③ Adjust the presser foot height. Select the height of the presser foot when the presser foot is raised.
- ④ Adjust the presser foot pressure. The higher the number, the greater the pressure will be. Set the pressure at [3] for normal sewing.
- ⑤ Adjust the amount of fabric feeding of the compact dual feed foot (page 47).
- ⑥ Select whether [1-01 Straight stitch (Left)] or [1-03 Straight stitch (Middle)] is the utility stitch that is automatically selected when the machine is turned on.
- ⑦ Select whether utility stitches  or quilting stitches  are displayed first in the stitch selection screen.
- ⑧ You can activate this setting after connecting the multi-function foot controller (Included with Some Models). (These settings appear when the multi-function foot controller is connected to the machine.) (page 51)
- ⑨ Select the height of the presser foot when sewing is stopped when the pivot setting is selected (page 61).
- ⑩ Select the height of the presser foot when the machine is set to free motion sewing mode (page 76).
- ⑪ When set to [ON], the thickness of the fabric is automatically detected by an internal sensor while sewing. This enables the fabric to be fed smoothly. (page 62, page 65)
- ⑫ When set to [ON], reinforcement stitches are sewn at the beginning and/or end of sewing for a reinforcement stitch pattern, even when  (Reverse stitch button) is pressed (page 55).
- ⑬ Adjust the guideline marker position and brightness (page 61).
- ⑭ Select whether to lower the presser foot automatically before starting sewing. (page 57)
- ⑮ Select whether to raise the presser foot automatically when stopping sewing. (page 57)
- ⑯ Select whether touching  (Thread cutter button) automatically lowers the presser foot before cutting the thread. The presser foot will be raised after the thread is cut. (page 57)
- ⑰ You can save the current settings screen image in a USB media by touching this key when the USB media is inserted into the USB port. The files are saved in a folder labeled [bPocket].
- ⑱ Reset settings on this page to original default. Some settings are not reset.

General Settings

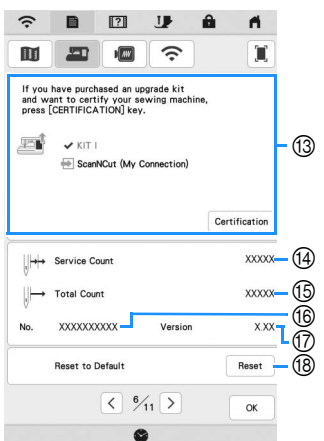
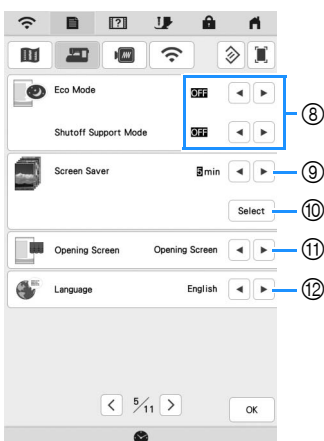
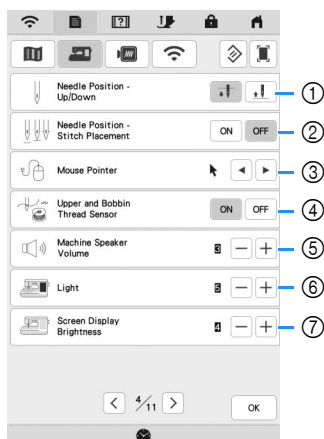

- ① Select the needle stop position (the needle position when the machine is not operating) to be up or down.
- ② Select the operation of the [Needle Position - Stitch Placement] to [ON] or [OFF]. (page 62)
- ③ Select the shape of the pointer when a USB mouse is used.
- ④ Turn both the upper and bobbin thread sensors [ON] or [OFF]. If it is turned [OFF], the machine can be used without thread.
- ⑤ Select the speaker volume. Increase the number for louder volume, decrease for softer volume.
- ⑥ Select the brightness of the work area lights.
- ⑦ Select the screen display brightness.
- ⑧ Set the [Eco Mode] and the [Shutoff Support Mode] to save the machine power (page 23).
- ⑨ Select the length of time until the screen saver appears.
- ⑩ Select the image of the screen saver (page 23).
- ⑪ Select the initial screen that is displayed when the machine is turned on.
- ⑫ Select the display language.
- ⑬ Use to certify your machine when you use [My Connection] function with Brother cutting machine (sold separately and limited to certain sales region). For details, visit the following webpage and refer to the "My Connection" Operation Manual. <https://s.brother/cmead/>



KIT I has been certified on this machine.

- ⑭ Shows the service count which is a reminder to take your machine in for regular servicing. (Contact your authorized Brother dealer for details.)
- ⑮ Shows the total number of stitches sewn on this machine.
- ⑯ Shows the internal machine number for this machine.
- ⑰ Shows the program version.
- ⑱ Erase all saved data, customized settings and network information in the machine.

IMPORTANT

- When [Upper and Bobbin Thread Sensor] is set to [OFF], the machine cannot detect tangled upper thread. Continuing to use the machine with tangled thread may cause damage.

■ Embroidery Settings

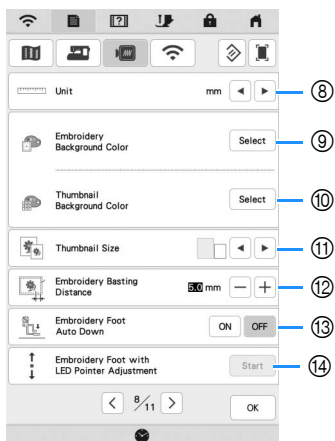
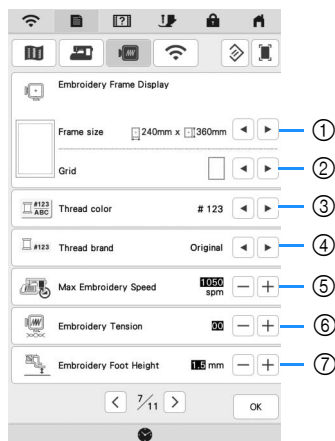

- ① Select the embroidery frame to be used.
- ② Select the center point marker or grid lines.
- ③ Select the thread color display on the embroidery screen; thread number, color name. (page 151)
- ④ Select the thread brand of the thread color display. (page 151)
- ⑤ Adjust the maximum embroidery speed (page 150).
- ⑥ Adjust the upper thread tension for embroidering (page 148).
- ⑦ Select the height of the embroidery foot during embroidering (page 126).
- ⑧ Select the display units for embroidering (mm/inch).
- ⑨ Select the color of the background for the embroidery display area.
- ⑩ Select the color of the background for the thumbnail area.
- ⑪ Select the size of pattern thumbnails.
- ⑫ Adjust the distance between the pattern and the basting stitching. (page 143)
- ⑬ When set to [ON], pressing the “Start/Stop” button when the embroidery foot is raised automatically lowers the embroidery foot before starting embroidering.
- ⑭ Adjust the position and brightness of the embroidery foot “W+” with LED pointer (this setting is available if embroidery foot “W+” with LED pointer has been attached.) (page 130).

■ Wireless LAN Settings

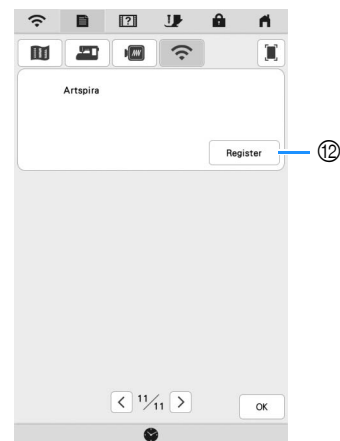
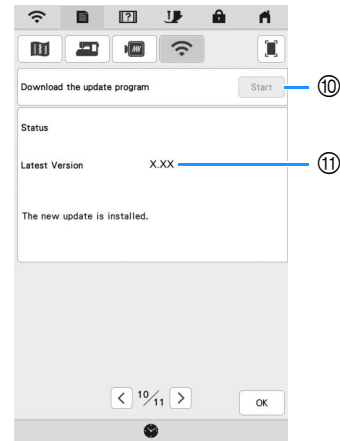
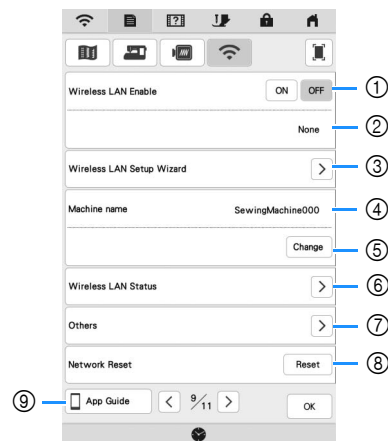

- ① Enable/Disable the wireless LAN function (page 28).
- ② Shows the connected SSID.
- ③ Set the machine to connect wireless LAN function.
- ④ Shows the machine name used on the wireless network.
- ⑤ Change the machine name used on the wireless network.
- ⑥ Check the wireless LAN status.
- ⑦ Display other menus.
- ⑧ Reset network operations.
- ⑨ Display the introduction to the applications. Touch the key of the app whose information you want to display. On smart devices with a QR reader app installed, scan the QR code to display a screen that shows how to install the app.



My Stitch Monitor: The machine's embroidering status can be monitored from your smart device. For details, refer to "MY STITCH MONITOR APP" on page 178.

My Design Snap: You can position your embroidery designs on the fabric, by capturing image of the hooped fabric and sending the image to your machine. For details, refer to "MY DESIGN SNAP APP" on page 179.

Artspira: You can transfer content published on the app to the embroidery machine and enjoy creating original works using the functions on the app.

- ⑩ If there is a new update program, download the update file. (page 196)
- ⑪ Display update program information. (page 196)
- ⑫ Register the Artspira app. (page 180)

■ Setting the [Eco Mode] and the [Shutoff Support Mode]

You can save the machine power by setting the [Eco Mode] and the [Shutoff Support Mode].

If you leave the machine turned on without using it for the set period of time, the machine enters in each mode.

Touch  to display [Eco Mode] and [Shutoff Support Mode]. (page 21)

[Eco Mode];

Machine will enter a sleep mode after the set period of time. Touch the screen or press the "Start/Stop" button to continue operating.

[Shutoff Support Mode];

Machine will enter the lower power mode after the set period of time. Turn the machine off and then back on to restart operating.

Memo

- If you turn off the machine while the machine is in the [Eco Mode] or the [Shutoff Support Mode], wait for about 5 seconds before turning on the machine again.
- For details on condition of the [Eco Mode] and [Shutoff Support Mode], refer to "SPECIFICATIONS" on page 194.

■ Changing the Screen Saver Image

Instead of the default image, you can select your own personal images for the screen saver of your machine. Before changing the screen saver image, prepare the image on USB media. For details on compatible image files, refer to "SPECIFICATIONS" on page 194.

1 Touch  .

→ The settings screen appears.

2 Touch  .

→ The general settings screen appears.

3 Display [Screen Saver] in the general settings screen.

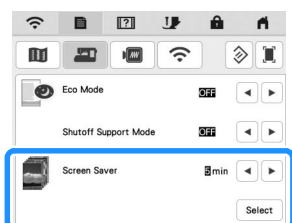

4 Touch  .

5 Touch  .

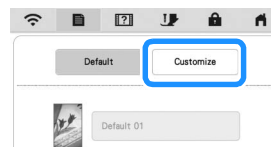

6 Connect the USB media that contains your personal image to the USB port of the machine.

7 Touch  to select the first image.

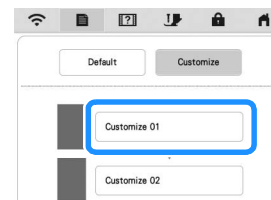

8 Select the device that is connected.

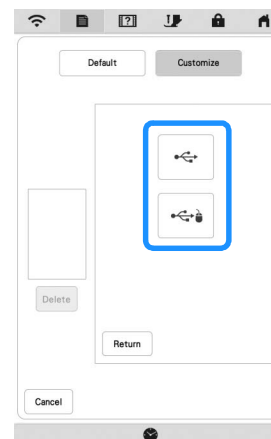

→ A list of your personal images appears on the screen.

*  : Delete the selected image.

*  : Return to the previous page.

9 Select a file name and then touch **Set** .



→ The selected image is stored on your machine.

* **Return** : Return to the previous page.

10 Repeat steps **7** through **9** to set the remaining images.

11 Touch **OK** to return to the original screen.

Memo

- Touch [Default] to select default images for the screen saver.



Using the Machine Help

Touch **?** to display the machine help screen. Functions are available from the screen shown below.

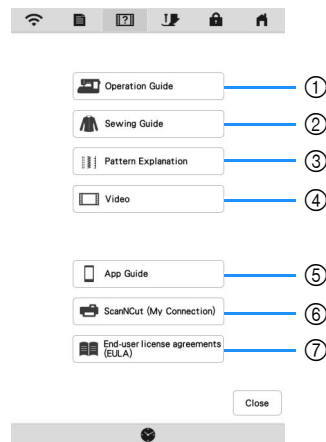

- ① Explanation for upper threading, winding the bobbin, preparing to embroider a pattern, and how to use the machine (page 25)
- ② Procedures for sewing utility stitches (page 25)
- ③ Explanation of the stitch selected
- ④ Tutorial videos or MPEG-4 (MP4) videos (page 25, page 26)
- ⑤ Display the introduction to the applications. Touch the key of the app whose information you want to display. On smart devices with a QR reader app installed, scan the QR code to display a screen that shows how to install the app.

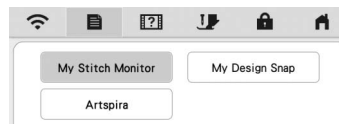

My Stitch Monitor: The machine's embroidering status can be monitored from your smart device. For details, refer to "MY STITCH MONITOR APP" on page 178.

My Design Snap: You can position your embroidery designs on the fabric, by capturing image of the hooped fabric and sending the image to your machine. For details, refer to "MY DESIGN SNAP APP" on page 179.

Artspira: You can transfer content published on the app to the embroidery machine and enjoy creating original works using the functions on the app.

- ⑥ Introduction to ScanNCut (My Connection)
- ⑦ End-user license agreements (EULA)

Using the Operation Guide Function

Touch to display the screen shown below. Categories are displayed at the top of the screen. Touch a key to see more information about that category. Some of the functions are described in the movies. Watch these movies for a better understanding of the functions.

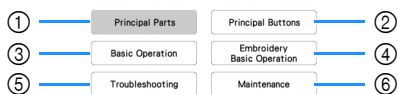

- ① Information about the main parts of the machine and their functions
- ② Information about the operation buttons
- ③ Information about threading the machine, changing presser feet, etc.
- ④ Information about attaching the embroidery unit, preparing fabric for embroidering, etc.
- ⑤ Information about troubleshooting
- ⑥ Information about cleaning the machine, etc.

Using the Sewing Guide Function

Use this function when you are not sure which stitch to use for your application, or to get advice about sewing particular stitches.

- 1 Enter Utility Stitch category from the home page.
- 2 Touch .
- 3 Touch . → The advice screen is displayed.
- 4 Touch the key of the category whose sewing instructions you wish to view.

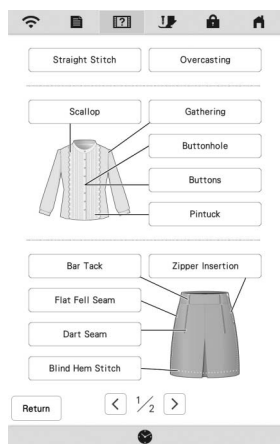

- 5 Read the explanations and select the appropriate stitch. → The screen displays directions for sewing the selected stitch. Follow the directions to sew the stitch.

Playing a Tutorial Video

This machine provides tutorial videos on how to use the machine.

- 1 Touch .

- 2 Touch .

- 3 Select the category and the tutorial video.

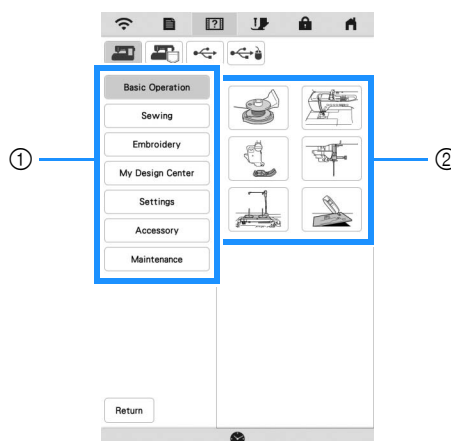

- ① Category
- ② Tutorial video

- 4 Play the tutorial video.

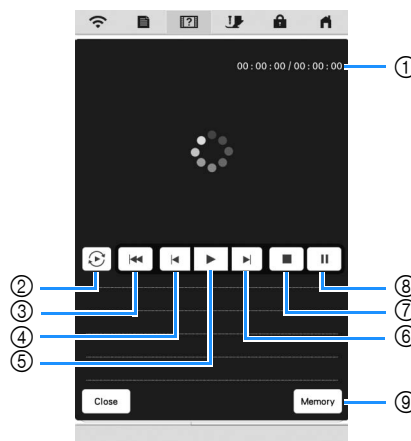

- ① Number of seconds elapsed/Total number of seconds
- ② Repeat
- ③ Return to beginning
- ④ Skip back 10 seconds
- ⑤ Play
- ⑥ Skip forward 10 seconds
- ⑦ Stop
- ⑧ Pause
- ⑨ Save to machine (when playing from USB media).

A video can be saved to (favorites) of the machine, from where it can be played. When playing from the machine's memory, changes to . Touch to delete the video.

Note

- The specifications shown in the movie may differ from the ones on the actual product, in details.
- The movie includes optional parts not included with this product.

- 5 After you are finished playing the video, touch .

■ Playing MPEG-4 (MP4) Videos

Your MP4 videos can be played from USB media. In addition, the MP4 video can be saved to the machine so that a tutorial video on creating a project, for example, can be viewed at any time. For details on supported file extensions, refer to “SPECIFICATIONS” on page 194.

Memo

- Some types of MP4 file cannot be played with the machine.

1 Touch .

2 Touch  Video.

3 Select the device where the video is saved.

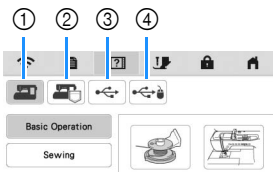

- ① Tutorial videos
- ② Videos saved on the machine (favorites)
- ③ Videos from USB media plugged into the USB port
- ④ Videos from USB media plugged into the USB port for mouse

4 Select the video that you want to play.

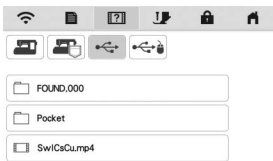

Note

- Long file names may be shortened when they are displayed.

5 Play the video.

- * Use the operation keys as described in “Playing a Tutorial Video” on page 25.

6 After you are finished playing the video, touch .

Using the Stitch Pattern Explanation Function

If you want to know more about the uses of a stitch pattern, select the pattern and touch  and then

 to see an explanation of the stitch selection.

Example: Displaying information about 

1 Touch .

2 Touch .

3 Touch .

→ The screen shows information.

4 Touch  to return to the original screen.

WIRELESS NETWORK CONNECTION FUNCTIONS

Operations Available with a Wireless Network Connection

This machine supports a wireless network connection. The following useful operations will be available if the machine is connected to a wireless network.

■ For updating

Directly download the update file to the machine. (page 196)

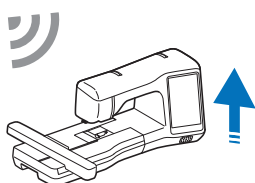

■ For embroidering

- Conveniently check the operating status of the machine from your smart device by using the dedicated mobile application (My Stitch Monitor).



- My Design Snap: You can position your embroidery designs on the fabric, by capturing image of the hooped fabric and sending the image to your machine.



- Wirelessly transfer an embroidery pattern from your computer to the machine by using the dedicated Windows application (Design Database Transfer). The application can be downloaded from the following URL.
<https://s.brother/caeka/>
- * Settings must be specified in Design Database Transfer. For more information, refer to the manual for Design Database Transfer.

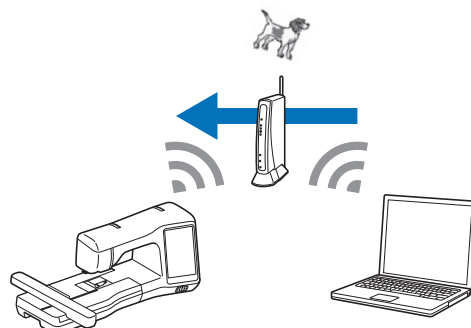

- Wirelessly transfer to the machine an embroidery pattern edited with embroidery editing software (PE-DESIGN version 11 or later) on a computer. Also, transfer to PE-DESIGN an embroidery pattern edited on the machine.
- * Settings must be specified in PE-DESIGN. For more information, refer to the manual for PE-DESIGN.

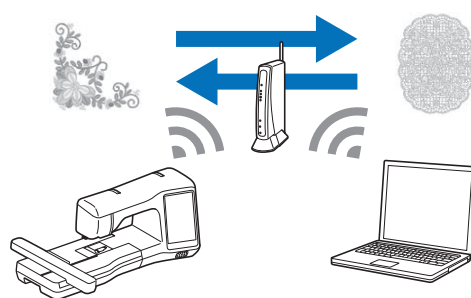

- With Artspira App, you can transfer content published on the app to the embroidery machine and enjoy creating original works using the functions on the app.
- When an updated version of the software is available on our website, the wireless LAN key appears as . (page 196)

Enabling a Wireless Network Connection

The machine can be connected to your wireless network. Refer to "SPECIFICATIONS" on page 194 for requirements for a wireless network connection.

1 Touch .

2 Set [Wireless LAN Enable] to [ON].

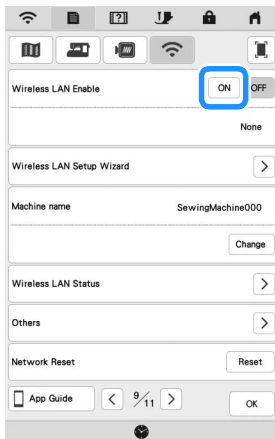

→ The machine begins to emit the wireless network signal.

Using the Wizard to Set Up the Wireless Network Connection

There are multiple ways to set up the wireless network connection. We recommend the method that uses the wizard on this machine.

1 In order to connect your machine to a wireless network, the security information (SSID and network key) for your home network will be required. The network key may also be called a password, security key or encryption key. First, find your security information and note it.

SSID	Network Key (Password)

Memo

- The wireless network connection cannot be set up if you do not have the security information.
- How to find the security information
 - ① Check the manual provided with your home network.
 - ② The default SSID may be the manufacturer's name or the model name.
 - ③ If you cannot find the security information, contact the manufacturer of the router, your network administrator or your Internet provider.
 - ④ Some SSIDs and network keys (passwords) are case (upper case and lower case) sensitive. Please properly record your information.

2 Touch  beside [Wireless LAN Setup Wizard].

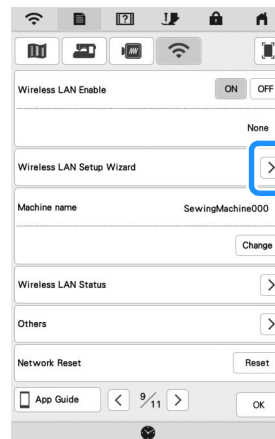



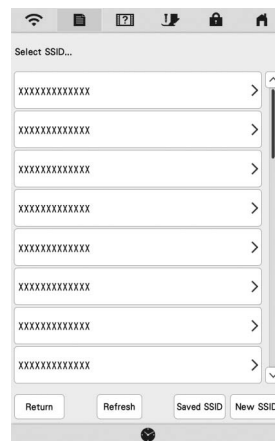

→ A list of available SSIDs appears.

3 Touch  beside the SSID that was noted.



→ The screen for entering the network key (password) appears.

Memo

- If the SSID that was noted does not appear in the list, touch .
- If the desired network SSID is not displayed, specify it as described below.
 - ① Select .
 - ② Enter the desired network SSID, and then touch .
 - ③ Select the authentication method and encryption mode.
- If the machine had already been connected to the home network, touch , and then select the saved SSID.

4 Enter the network key (password) that was noted, and then touch .

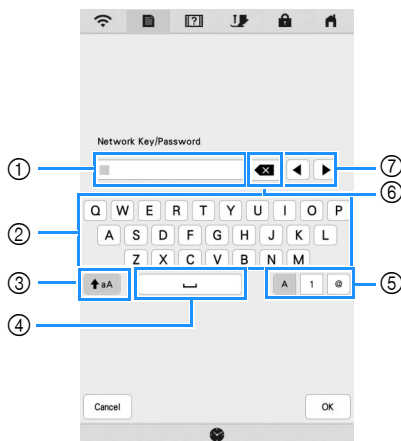

- ① Text input area
- ② Character keys
- ③ Caps key
- ④ Space key
- ⑤ Letters/numbers/symbols key
- ⑥ Backspace key (Deletes the character at the cursor's position.)
- ⑦ Cursor keys (Move the cursor to the left or right.)

5 When the following message appears, touch .

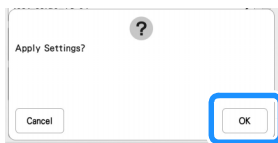

→ When a connection is established, the following message appears.

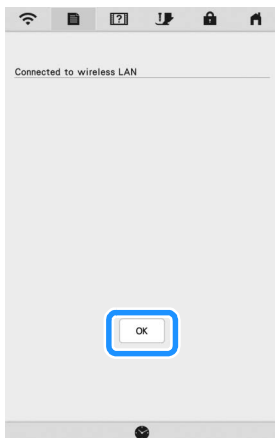

6 Touch to exit the setup.

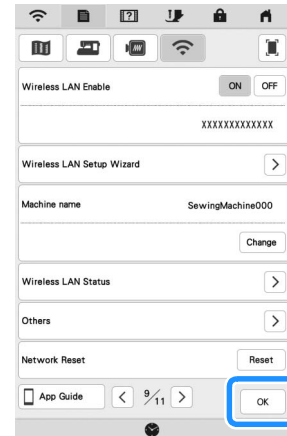

→ The name beside [Machine name] is the name that will be used when registering the machine with embroidery editing software (PE-DESIGN version 11 or later) or Design Database Transfer in order to transfer files.

Memo

- While connected, the signal strength is indicated by the icon in the upper-left corner of the display.
- Once a wireless network connection has been set up, a connection will be established each time the machine is turned on. However, [Wireless LAN Enable] in the network settings screen must remain set to [ON].
- The name in the [Machine name] field will be used with the Artspira App (limited to certain sales region), My Stitch Monitor App and My Design Snap App.

Using the [Others] Menu To Set Up the Wireless Network Connection

The [Others] menu contains the following items.

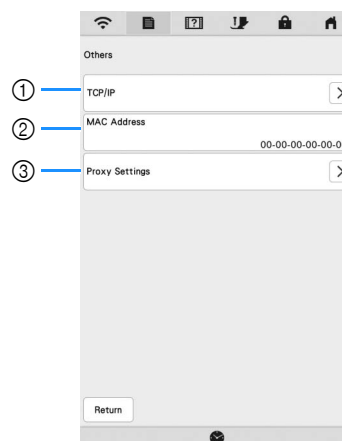

- ① TCP/IP settings can be manually entered.
- ② Shows the MAC address.
- ③ Use when proxy settings are required.

CONNECTING THE ACCESSORY TO THE MACHINE

Using a USB Mouse

A USB mouse, connected to the machine, can be used to perform a variety of operations in the screens. Connect a USB mouse to the USB port.

Memo

- Use a basic computer mouse to operate the machine functions. Some USB mouse devices may not be compatible with this machine.

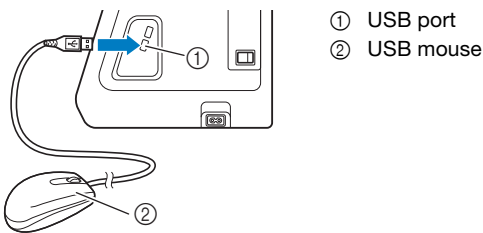

Note

- The left mouse button can be used to perform operations such as choosing a design and choosing menu keys.
- The mouse pointer does not appear in the screen saver or opening screen.

Clicking a Key

When the mouse is connected, the pointer appears on the screen. Move the mouse to position the pointer over the desired key, and then click the left mouse button.

Memo

- Double-clicking has no effect.

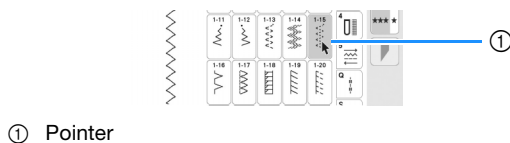

① Pointer

WINDING/INSTALLING THE BOBBIN

Winding the Bobbin

IMPORTANT

- Use the plastic bobbins that came with this machine or bobbins of the same type: 11.5 mm (approx. 7/16 inch) plastic Class 15 (A style) bobbins, which are available from your Brother dealer.

Using the Supplemental Spool Pin

With this machine, you can wind the bobbin during sewing. While using the main spool pin to sew or embroider, you can conveniently wind the bobbin using the supplemental spool pin.

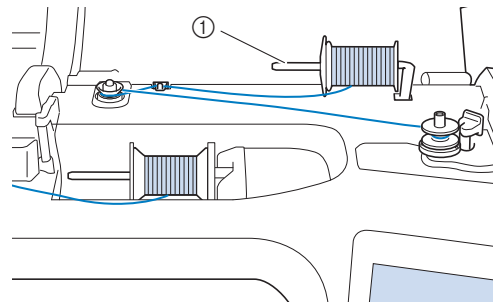

① Supplemental spool pin

- 1 Turn the main power to ON and open the top cover.

- 2 Align the groove in the bobbin with the spring on the bobbin winder shaft, and set the bobbin on the shaft.

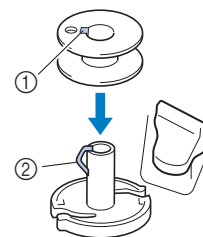

- ① Groove in the bobbin
- ② Spring on the bobbin winder shaft

- 3 Place the spool of thread for the bobbin and the spool cap onto the supplemental spool pin.

Slide the spool onto the supplemental spool pin so that the thread unwinds to the front from the bottom. Otherwise the thread may become tangled around the supplemental spool pin.

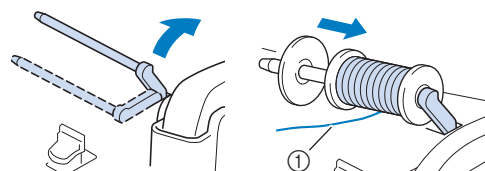

- ① The thread unwinds to the front from the bottom.

- 4 Slide the spool cap onto the spool pin as far as possible to the right, with the rounded side on the left.

IMPORTANT

- If the spool or the spool cap is not installed correctly, the thread may become tangled around the spool pin, and the machine may be damaged.
- Three spool cap sizes are available, allowing you to choose a spool cap that best fits the size of spool being used. If the spool cap is too small for the spool being used, the thread may catch on the slit in the spool or the machine may be damaged. When using mini king thread spool, use the thread spool insert. For details on thread spool insert (mini king thread spool), refer to "Note" on page 31.



Note

- When using the spool as shown below, use the thread spool insert (mini king thread spool). Make sure that the thread spool insert is firmly inserted. After installing it, pull out some thread, and check that the thread unwinds without getting caught.

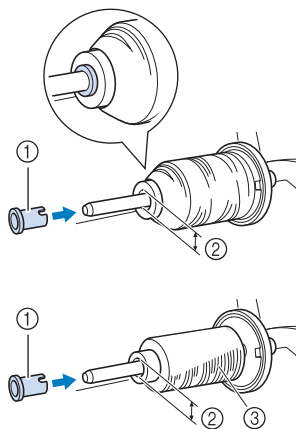

- ① Thread spool insert (mini king thread spool)
- ② Hole diameter 8.0 mm to 10.5 mm (approx. 5/16 inch to 13/32 inch)
- ③ Spool (cross-wound thread)

- When using thread that winds off quickly, such as transparent nylon thread or metallic thread, place the spool net over the spool before placing the spool of thread onto the spool pin. If the spool net is too long, fold it to fit the size of the spool.

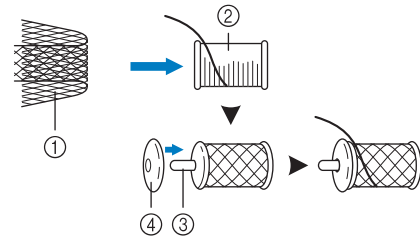

- ① Spool net
- ② Thread spool
- ③ Spool pin
- ④ Spool cap

- * When threading the spool with the spool net on, make sure that 5-6cm (approx. 2 - 2-1/2 inches) of thread is pulled out.
- * It may be necessary to adjust the thread tension when using the spool net.

- 5 With your right hand, hold the thread near the thread spool. With your left hand, hold the end of the thread, and use both hands to pass the thread through the thread guide.

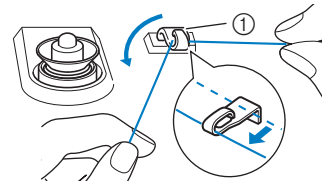

- ① Thread guide

- 6** Pass the thread around the pretension disk making sure that the thread is under the pretension disk.

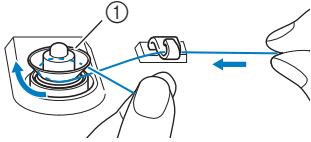

- ① Pretension disk
→ Make sure that the thread passes under the pretension disk.

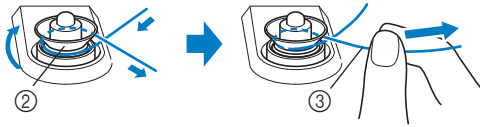

- ② Pretension disk
③ Pull it in as far as possible.
→ Check to make sure thread is securely set between pretension disks.

- 7** Wind the thread clockwise around the bobbin 5 or 6 times, pass the thread through the guide slit in the bobbin winder seat, and then pull the thread to cut it.

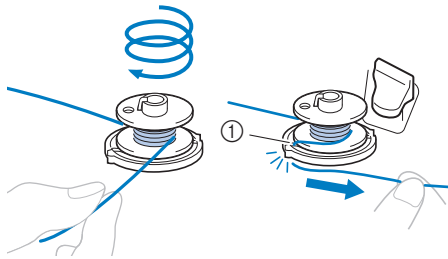

- ① Guide slit in bobbin winder seat (with built-in cutter)

Note

- Be sure to wind the thread clockwise around the bobbin, otherwise the thread may become wrapped around the bobbin winder shaft.

CAUTION

- Be sure to cut the thread as described. If the bobbin is wound without cutting the thread using the cutter built into the guide slit in the bobbin winder seat, the thread may become tangled in the bobbin or the needle may break and cause injury when the bobbin thread starts to run out.

- 8** Set the bobbin winding switch to the left, until it clicks into place.

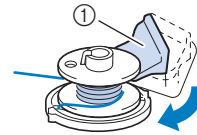

- ① Bobbin winding switch
→ The bobbin winding window appears.

- 9** Touch .

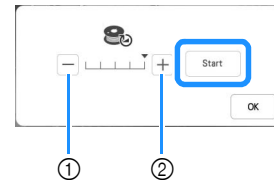

- ① Touch to decrease the winding speed.
② Touch to increase the winding speed.

→ Bobbin winding starts. changes to while the bobbin is winding. The bobbin stops rotating when bobbin winding is completed. The bobbin winding switch will automatically return to its original position.

Memo

- Touch to minimize the bobbin winding window. Then, you can perform other operations, such as selecting a stitch or adjusting the thread tension, while the bobbin is being wound.
- Touch  (in top right of the LCD screen) to display the bobbin winding window again.

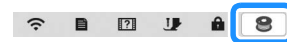

- The sound of winding the bobbin with stiff thread, such as nylon thread for quilting, may be different from the one produced when winding normal thread; however, this is not a sign of a malfunction.

IMPORTANT

- When winding transparent nylon thread on the bobbin, stop bobbin winding when the bobbin is 1/2 to 2/3 full. If the bobbin was fully wound with transparent nylon thread, it may not be wound neatly, or sewing performance may suffer. In addition, extreme pressure may be applied to the bobbin, it may not be possible to remove the bobbin from the bobbin winder shaft, or the bobbin may break.



- 10** After bobbin winding is finished, cut the thread with scissors and remove the bobbin.

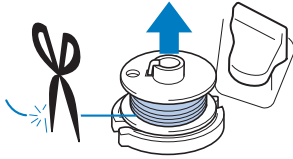

IMPORTANT

- When removing the bobbin, do not pull on the bobbin winder seat. Doing so could loosen or remove the bobbin winder seat, and could result in damage to the machine.

■ Using the Spool Pin

You can use the main spool pin to wind the bobbin before sewing. You cannot use this spool pin to wind the bobbin while sewing.

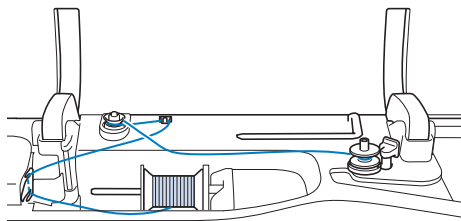

- 1** Turn the main power to ON and open the top cover.
- 2** Align the groove in the bobbin with the spring on the bobbin winder shaft, and set the bobbin on the shaft.

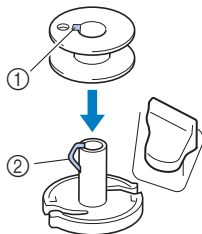

- ① Groove in the bobbin
② Spring on the bobbin winder shaft

- 3** Remove the spool cap and place the spool of thread for the bobbin onto the spool pin.

Slide the spool onto the spool pin so that the thread unwinds to the front from the bottom.

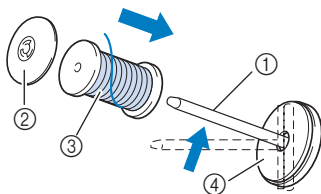

- ① Spool pin
② Spool cap
③ Spool of thread
④ Spool felt

- 4** Slide the spool cap onto the spool pin as far as possible to the right, with the rounded side on the left.

- 5** While holding the thread with both hands, pass the thread through grooves of the thread guide plate.

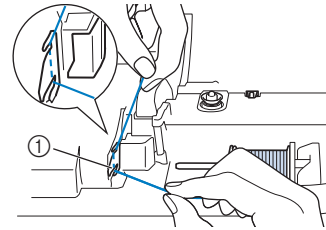

- ① Thread guide plate

- 6** Pass the thread through the thread guide.

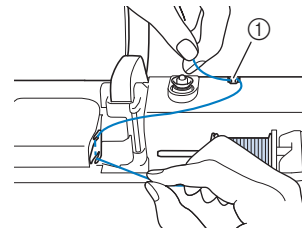

- ① Thread guide

- 7** Pass the thread around the pretension disk making sure that the thread is under the pretension disk.

Pull the thread as far as possible.

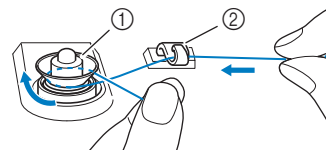

- ① Pretension disk
② Thread guide

- 8** Follow steps **7** through **10** on page 32 through page 33.

■ Using the Spool Stand (Included with Some Models)

To wind thread on the bobbin while the spool stand is installed, pass the thread from the spool through the thread guide on the telescopic thread guide, and then wind the bobbin according to steps 5 through 10 of “Using the Supplemental Spool Pin” on page 31 to page 33.

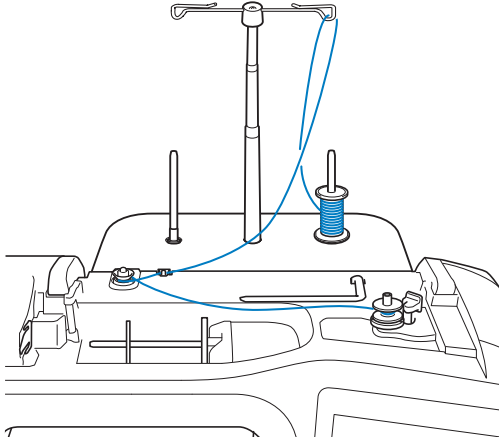

IMPORTANT

- When winding thread on the bobbin, do not cross the bobbin winding thread with the upper thread in the thread guides.

Setting the Bobbin

⚠ CAUTION

- Use a bobbin that has been correctly wound with thread, otherwise the thread tension may be incorrect and the needle may break, causing injuries.



- Before inserting or changing the bobbin, be sure to touch  in the LCD to lock all keys and buttons. Otherwise injuries may occur if the “Start/Stop” button or any other button is pressed and the machine starts sewing.

- 1 Touch  to lock all keys and buttons and raise the presser foot.

* If the message [OK to automatically lower the presser foot?] appears on the LCD screen, touch

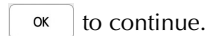

- 2 Slide the bobbin cover latch to the right.

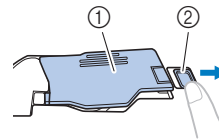

- ① Bobbin cover
- ② Latch
- The bobbin cover opens.

- 3 Remove the bobbin cover.

- 4 Hold the bobbin with your right hand and hold the end of the thread with your left hand.

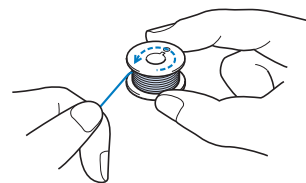

- 5 Set the bobbin in the bobbin case so that the thread unwinds to the left.

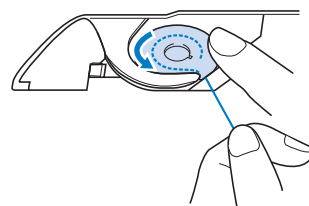

- 6** Lightly hold down the bobbin with your right hand, and then guide the end of the thread around the tab of the needle plate with your left hand.

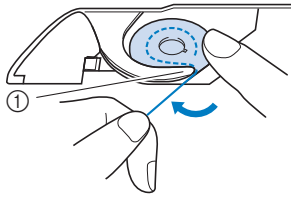

① Tab

Note

- Be sure to hold down the bobbin with your finger and unwind the bobbin thread correctly, otherwise the thread may break or the thread tension will be incorrect.

- 7** While lightly holding down the bobbin with your right hand, guide the thread through the slit in the needle plate and lightly pull it with your left hand.

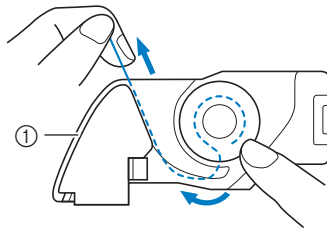

① Slit

Memo

- By pulling the thread in this way, the thread will enter the tension spring of the bobbin case to apply the appropriate tension to the bobbin thread during sewing.

- 8** While lightly holding down the bobbin with your right hand, continue guiding the thread through the slit with your left hand. Then, cut the thread with the cutter.

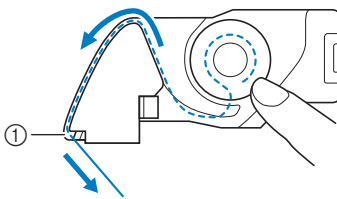

① Cutter

→ The cutter cuts the thread.

- 9** Insert the tab in the lower-left corner of the bobbin cover (①), and then lightly press down on the right side to close the cover (②).



- 10** Touch  to unlock all keys and buttons.

Memo

- You can begin sewing without pulling up the bobbin thread. If you wish to pull up the bobbin thread before starting to sew, pull up the thread according to the procedure in “Pulling Up the Bobbin Thread” on page 35.

Pulling Up the Bobbin Thread



There may be some sewing applications where you want to pull up the bobbin thread; for example, when making gathers, darts, or doing free motion quilting or embroidery.

Memo

- You can pull up the bobbin thread after threading the upper thread (“UPPER THREADING” on page 36).

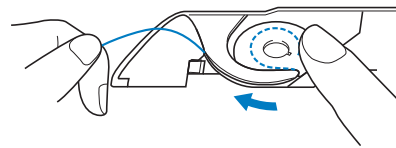
- 1** Follow steps **1** to **5** in “Setting the Bobbin” on page 34 for installing the bobbin into the bobbin case.
- 2** Guide the bobbin thread through the groove, following the arrow in the illustration.
- * Do not cut the thread with the cutter.
 - * Do not replace the bobbin cover.



- 3** Touch  to unlock all keys and buttons.
- 4** While lightly holding the upper thread with your left hand, press  (Needle position button) twice to lower and then raise the needle.

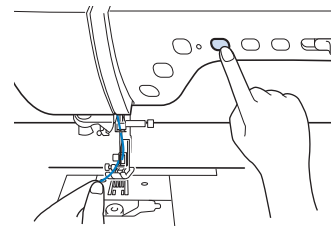

- 5** Gently pull the upper thread. A loop of the bobbin thread will come out of the hole in the needle plate.

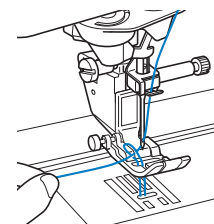

- 6** Pull up the bobbin thread, pass it under the presser foot and pull it about 10 cm (approx. 4 inches) toward the back of the machine, making it even with the upper thread.

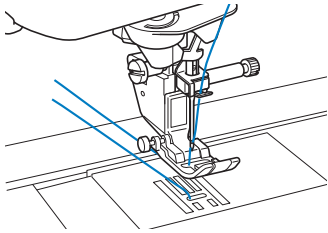

- 7** Reattach the bobbin cover.

UPPER THREADING

Upper Threading

⚠ CAUTION

- Be sure to thread the machine properly. Improper threading can cause the thread to tangle and break the needle, leading to injury.

IMPORTANT

- Never use a thread weight of 20 or lower. It may cause the machine to malfunction. Use the needle and the thread in the correct combination. For details on the correct combination of needles and threads, refer to "FABRIC/THREAD/NEEDLE COMBINATIONS" on page 44.
- When using 65/09 needle, manually thread the needle. If the automatic needle threading function is used, the unit may be damaged.

📝 Memo

- The automatic threading function can be used with home sewing machine needle sizes 75/11 through 100/16.
- When threads such as transparent nylon monofilament or specialty threads are used, it is not recommended to use the needle threader.
- The automatic threading function cannot be used with the twin needle.

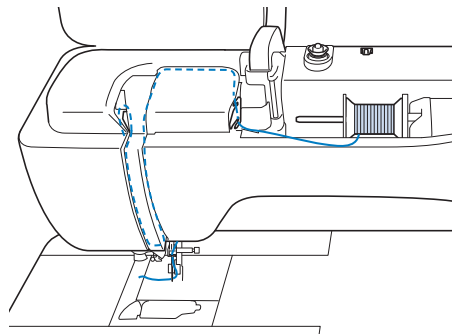

1 Turn the main power to ON.

2 Press  (Presser foot lifter button) to raise the presser foot.

→ The upper thread shutter opens so the machine can be threaded.

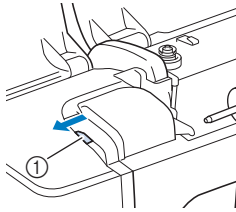

① Upper thread shutter

3 Press  (Needle position button) to raise the needle.

IMPORTANT

- Be sure to raise the needle before using the automatic needle threader. Otherwise, the needle may not thread correctly and the needle threader may be damaged.

4 Remove the spool cap and place the spool of thread onto the spool pin.

Slide the spool onto the spool pin so that the thread unwinds to the front from the bottom.

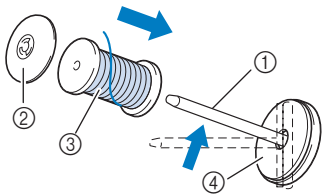

- ① Spool pin
- ② Spool cap
- ③ Spool of thread
- ④ Spool felt

5 Slide the spool cap onto the spool pin as far as possible to the right, with the rounded side on the left.

CAUTION

- Choose a spool cap that best fits the size of spool being used. For more information, refer to "Note" on page 31.

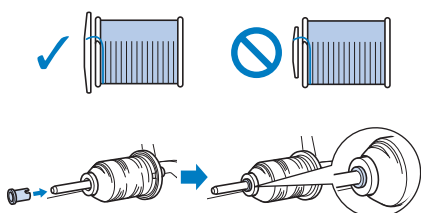

- If the spool or the spool cap is not positioned correctly, the thread may become tangled around the spool pin, possibly causing the needle to break, resulting in injuries.

6 While holding the thread with both hands, pass the thread through grooves of the thread guide plate.

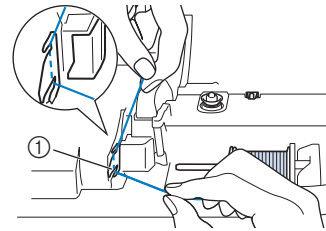

① Thread guide plate

7 While holding the thread in your right hand, pass the thread through the thread guide in the direction indicated.

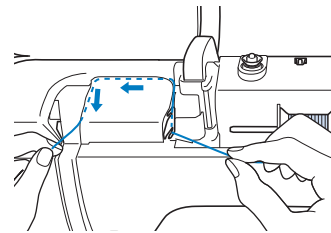

8 Guide the thread down, up, then down through the groove, as shown in the illustration.

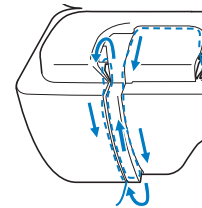

Memo

- Look in the upper groove area to check if the thread catches on the thread take-up lever visible inside the upper groove area.

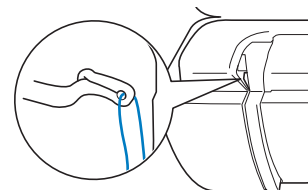

9 Pass the thread through the needle bar thread guide (marked "6") by holding the thread with both hands and guiding it as shown in the illustration.

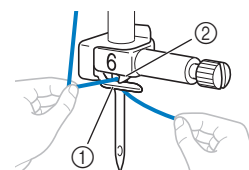

- ① Needle bar thread guide
- ② Tab

- 10** Pass the thread through the notch in the thread guide. Then firmly pull the thread from front to back into the slit of the thread guide disk (marked "7").

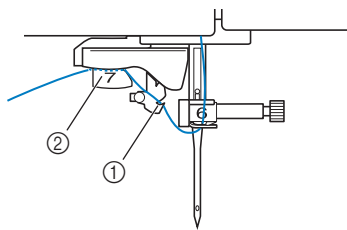

- ① Notch in thread guide
- ② Thread guide disk

- 11** Press  (Presser foot lifter button) to lower presser foot.

- 12** Pull the thread up through the thread cutter to cut the thread, as shown in the illustration.

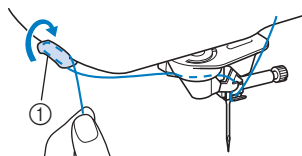

- ① Thread cutter

Note

- When using thread that quickly winds off the spool, such as metallic thread, it may be difficult to thread the needle if the thread is cut. Therefore, instead of using the thread cutter, pull out about 8 cm (approx. 3 inches) of thread after passing it through the thread guide disks (marked "7").

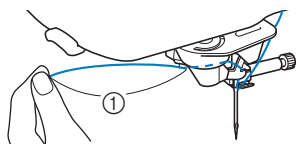



- ① About 8 cm (approx. 3 inches) or more

- 13** Press  (Automatic threading button) to have the machine automatically thread the needle.

→ The thread passes through the eye of the needle.

Memo

- When  (Automatic threading button) is pressed, the presser foot will be automatically lowered. After threading is finished, the presser foot moves back to the position before  (Automatic threading button) was pressed.

- 14** Carefully pull the end of the thread that was passed through the eye of the needle.

- * If a loop was formed in the thread passed through the eye of the needle, carefully pull on the loop of thread through to the back of the needle.

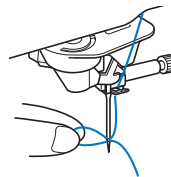

- 15** Raise the presser foot lever and pull out about 10 cm (approx. 4 inches) of the thread, and then pass it under the presser foot toward the rear of the machine.

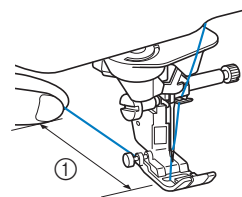

- ① About 10 cm (approx. 4 inches)

Memo

- If the needle could not be threaded or the thread was not passed through the needle bar thread guides, perform the procedure again starting from step **3**.

Note

- Some needles and threads cannot be threaded with the needle threader. In this case, instead of using the needle threader after passing the thread through the needle bar thread guide (marked "6"), manually pass the thread through the eye of the needle from the front.

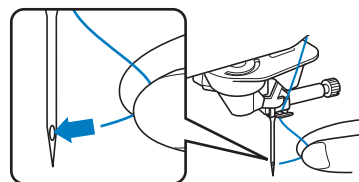

■ Using the Vertical Spool Pin (Included with Some Models)

Use the vertical spool pin when using an irregularly shaped thread spool, and when sewing with metallic thread.

- 1 Insert the vertical spool pin onto the bobbin winder shaft.

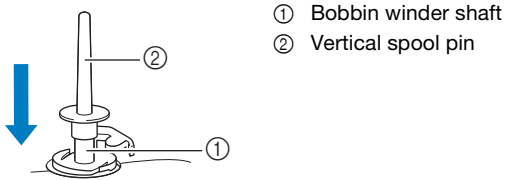

- 2 Install the spool felt and the thread spool in that order, and then thread the upper thread.

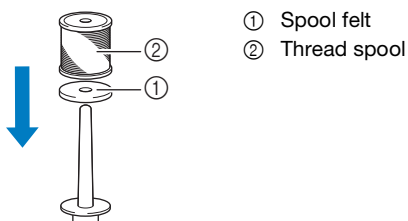

Memo

- When setting the thread spool, set it so that the thread winds off from the front of the spool.
- If using metallic thread, we recommend that you use a 90/14 home sewing machine needle.
- This method keeps the thread from twisting as it comes off the spool pin.

Using the Twin Needle Mode

The twin needle can only be used for stitch patterns that show  after being selected. Before you select a stitch pattern, make sure the stitch can be sewn in the twin needle mode (refer to the “STITCH SETTING CHART” on page 197).

CAUTION

- When using the twin needle, it is recommended to use presser foot “J”. Otherwise, the needle may break and cause injury.
- Before changing the needle or threading the machine, be sure to touch  on the LCD screen to lock all keys and buttons, otherwise injuries may occur if the “Start/Stop” button or any other button is pressed and the machine starts sewing.

IMPORTANT

- Twin needle (size 2/11) is recommended for this machine. Contact your authorized Brother dealer for replacement needles.

Note

- When the twin needle is used, bunched stitches may occur depending on the types of fabric and thread that are used. Use advanced monogramming foot “N+” or attach stabilizer material.

- 1 Touch  to lock all keys and buttons and then install the twin needle (“CHANGING THE NEEDLE” on page 42).

- * If the message [OK to automatically lower the presser foot?] appears on the LCD screen, touch

 to continue.

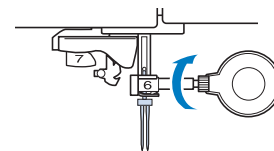

- 2 Thread the machine for the first needle according to the procedure for threading a single needle (“Upper Threading” on page 36).

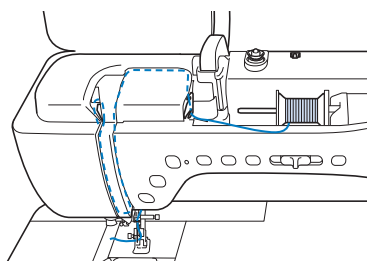

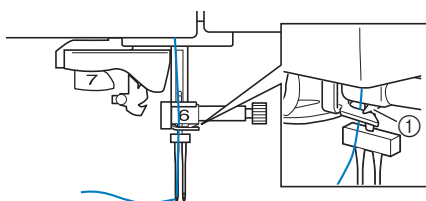

- 3 Pass the thread through the needle bar thread guides on the needle bar, then thread the needle on the left side manually.



① Needle bar thread guide

IMPORTANT

-  (Automatic threading button) cannot be used. Manually thread the twin needle from front to back. Using  (Automatic threading button) may result in damage to the machine.

- 4 Pull up the supplemental spool pin and set it in the up position. Place the additional spool of thread on the supplemental spool pin, so that the thread unwinds from the front. Push the spool cap onto the spool pin as far as possible to secure the thread spool.

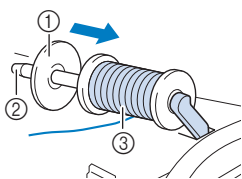

① Spool cap
② Spool pin
③ Spool of thread

- 5 Hold the thread from the spool with both hands, and place the thread in the thread guide.

* Do not place the thread in the pretension disks.

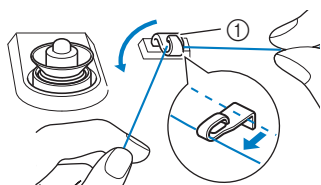

① Thread guide

- 6 While holding the thread from the spool, pull the thread through the lower notch in the thread guide plate, then through the upper notch. Hold the end of the thread with your left hand, and then guide the thread through the groove, following the arrows in the illustration.

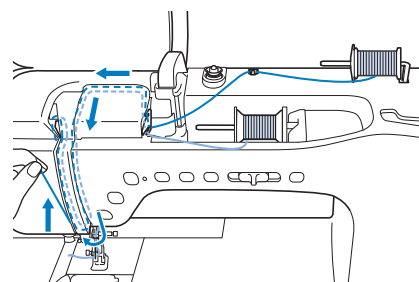

- 7 Continue threading; however, do not pass the thread in the needle bar thread guide “6” on the needle bar. Thread the needle on the right side.

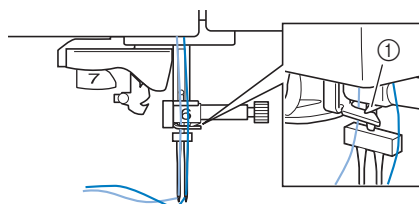

① Needle bar thread guide

- 8 Touch  to unlock all keys and buttons.

- 9 Select a stitch pattern.

- * Refer to “Basic Sewing” on page 49 for selecting a stitch pattern.
- * Refer to “STITCH SETTING CHART” on page 197 for the proper stitch to use with presser foot “J”.

- 10 Touch  to select the twin needle mode.

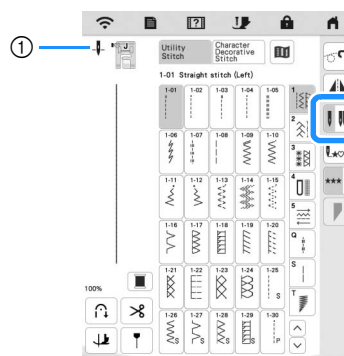

① Single needle/twin needle position setting display

→  appears.

CAUTION

- Be sure to set the twin needle mode when using the twin needle. Using the twin needle while the machine is in single needle mode could cause the needle to break and cause injury.

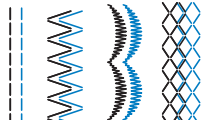
11 Start sewing.**Memo**

- To change direction when sewing with the twin needle, raise the needle from the fabric, raise the presser foot lever, and then turn the fabric.

Using the Spool Stand

The spool stand is useful when using thread on spools with a large diameter (cross-wound thread). This spool stand can hold two spools of thread.

Using the Spool Stand (Included with Some Models)

- Be sure to use a spool cap that is slightly larger than the spool.
If the spool cap that is used is smaller or much larger than the spool, the thread may catch and sewing performance may suffer.

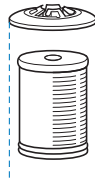

- When using thread on a thin spool, place the included spool felt on the spool pin, place the thread spool on the spool pin so that the center of the spool is aligned with the hole at the center of the spool felt, and then insert the spool cap onto the spool pin.

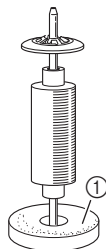

① Spool felt

- When using thread on a cone spool, use the spool holder. When using cone shaped thread spool with other than cotton thread, it is not necessary to use spool caps.

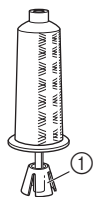

① Spool holder

- Depending on the size of spool or the amount of thread remaining, choose the appropriate sized spool cap (large or medium). Spool cap (small) cannot be used with the spool cap base.

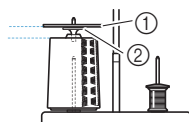
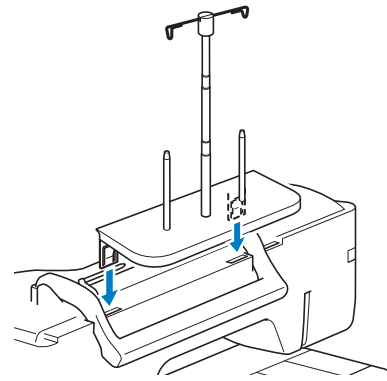
① Spool cap
② Spool cap base**1 Attach the spool stand to the machine. (page 12)**

- 2** Place the spool of thread on the spool pin so that the thread feeds off the spool clockwise. Firmly insert the spool cap onto the spool pin.

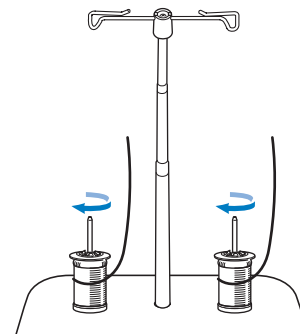
**CAUTION**

- Make sure that the spools do not touch each other, otherwise the thread will not feed off smoothly, the needle may break and cause injury. In addition, make sure that the spools do not touch the telescopic thread guide at the center.

Note

- When using two spools of thread, make sure that both spools are feeding in the same direction.
- Make sure that the thread is not caught under the spool.

3 Pull the thread off the spool. Pass the thread from the back to the front through the thread guides at the top.

When using thread that quickly feeds off the spool, such as metallic thread, use the enclosed ring to prevent the thread from becoming entangled. Threading sequence; Pull the thread from the spool, place the thread through the ring from the bottom up (①), into the thread guide (②) and through the ring from the top down (③). When using the ring, do not use the spool cap base.

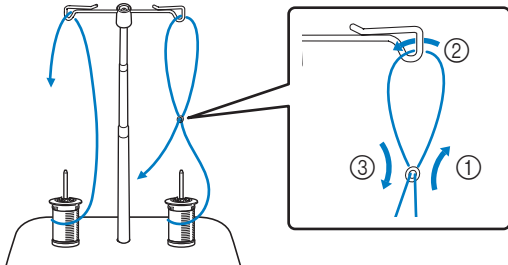

Note

- Guide the thread so that it does not become entangled with the other thread.
- After feeding the thread as instructed, wind any excess thread back onto the spool, otherwise the excess thread will become tangled.

4 Pass the thread through the machine's thread guide from the right to the left.

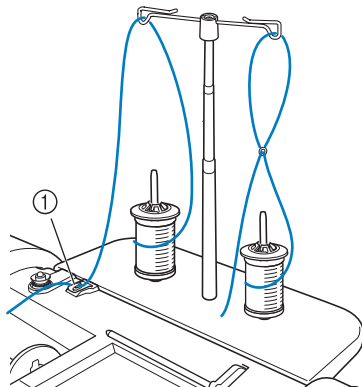



① Thread guide

5 Thread the machine according to the steps 6 to 15 of "Upper Threading" on page 37.

CHANGING THE NEEDLE

CAUTION

- Always touch  on the screen to lock all keys and buttons before changing the needle. If  is not touched and the "Start/Stop" button or another operation button is pressed accidentally, the machine will start and injury may result.
- Use only home sewing machine needles. Other needles may break and may cause injury.
- Never use a bent needle. This may cause injury.

Memo

- To check the needle correctly, place the flat side of the needle on a flat surface. Check the needle from the top and the sides. Throw away any bent needles.

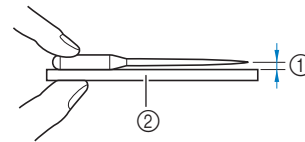

- ① Parallel space
- ② Flat surface (bobbin cover, glass, etc.)

- The machine needles are consumables. Replace the needle in cases such as those described below.
 - If an unusual sound is produced when the needle enters the fabric. (The tip of the needle may be broken or dull.)
 - If stitches are skipped. (The needle may be bent.)
 - Generally, after completing one project, such as a piece of clothing.

1 Press  (Needle position button) to raise the needle.

2 Touch  to lock all keys and buttons.

* If the message [OK to automatically lower the presser foot?] appears on the LCD screen, touch to continue.

Note

- Before replacing the needle, cover the hole in the needle plate with fabric or paper to prevent the needle from falling into the machine.

- 3 Remove the presser foot. (page 45)
- 4 Use the disc-shaped screwdriver to turn the needle clamp screw toward you (counterclockwise) to loosen the screw. Remove the needle.

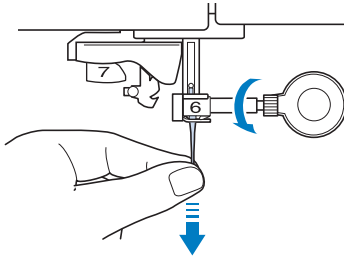

- 5 With the flat side of the needle facing the back, insert the new needle all the way to the top of the needle stopper (viewing window) in the needle clamp. Use the disc-shaped screwdriver to securely tighten the needle clamp screw.

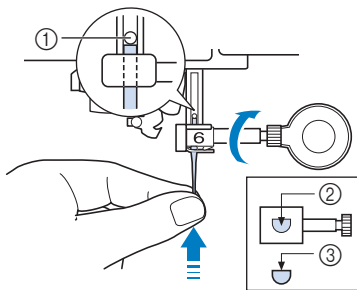

- ① Needle stopper
- ② Hole for inserting the needle
- ③ Flat side of the needle

⚠ CAUTION

- Be sure to push in the needle until it touches the stopper, and securely tighten the needle clamp screw with the disc-shaped screwdriver. If the needle is not completely inserted or the needle clamp screw is loose, the needle may break and cause injury.

- 6 Attach the presser foot. (page 45)
- 7 Touch  to unlock all keys and buttons.

Memo

- The automatic threading function can be used with home sewing machine needle sizes 75/11 through 100/16.
- When threads such as transparent nylon monofilament or specialty threads are used, it is not recommended to use the needle threader.

FABRIC/THREAD/NEEDLE COMBINATIONS

- **Needles that can be used with this machine: Home sewing machine needles (size 65/9 - 100/16)**
* The larger the number, the larger the needle. As the numbers decrease, the needles get finer.
- **Thread that can be used with this machine: 30 - 90 weight**
* Never use thread of 20 weight or lower. It may cause machine to malfunction.
* The smaller the number, the heavier the thread. As the numbers increase, the thread gets finer.
- **The machine needle and thread that should be used depends on the type and thickness of the fabric. Refer to the following table when choosing the thread and needle appropriate for the fabric that you wish to sew.**
 - The combinations shown in the table provide a general guideline. Be sure to sew trial stitches on the actual number of layers and type of fabric to be used in your project.
 - The machine needles are consumables. For safety and best results, we recommend replacing the needle regularly. For details on when to replace the needle, refer to “CHANGING THE NEEDLE” on page 42.
- **In principle, use a fine needle and thread with lightweight fabrics, and a larger needle and heavier thread with heavyweight fabrics.**
- **Select a stitch appropriate for the fabric, and then adjust the stitch length. When sewing lightweight fabrics, make the stitch length finer (shorter). When sewing heavyweight fabrics, make the stitch length coarser (longer). (page 58)**
When sewing stretch fabrics, refer to “Sewing Stretch Fabrics” on page 66.

Fabric Type/Application		Thread		Size of needle	Stitch length mm (inch)
		Type	Weight		
Lightweight fabrics	Lawn, georgette, challis, organdy, crepe, chiffon, voile, gauze, tulle, lining, etc.	Polyester thread	60 - 90	65/9 - 75/11	Fine stitches 1.8-2.5 (approx. 1/16-3/32)
		Cotton thread Silk thread	50 - 80		
Medium weight fabrics	Broadcloth, taffeta, gabardine, flannel, seersucker, double gauze, linen, terry cloth, waffle weave, sheeting, poplin, cotton twill, satin, quilting cotton, etc.	Polyester thread	60 - 90	75/11 - 90/14	Regular stitches 2.0-3.0 (approx. 1/16-1/8)
		Cotton thread Silk thread	50 - 60		
Heavyweight fabrics	Denim (12 ounces or more), canvas, etc.	Polyester thread	30	100/16	Coarse stitches 2.5-4.0 (approx. 3/32-3/16)
		Cotton thread	60	90/14 - 100/16	
	Denim (12 ounces or more), canvas, tweed, corduroy, velour, melton wool, vinyl-coated fabric, etc.	Polyester thread Cotton thread Silk thread	30 - 50		
Stretch fabrics (knit fabrics, etc.)	Jersey, tricot, T-shirt fabric, fleece, interlock, etc.	Polyester thread Cotton thread Silk thread	50	Ball point needle 75/11 - 90/14	Setting appropriate for the fabric thickness
For top-stitching		Polyester thread	30	90/14 - 100/16	Setting appropriate for the fabric thickness
		Cotton thread	50 - 60	75/11 - 90/14	

■ Transparent Nylon Thread

Use a home sewing machine topstitching needle, regardless of the fabric or thread.

■ Sewing Character Stitch Patterns and Decorative Stitch Patterns (Needles and Threads)

When sewing lightweight, medium weight or stretch fabrics, use a ball point needle (gold colored) 90/14. When sewing heavyweight fabrics, use a home sewing machine needle 90/14.

In addition, #50 to #60 thread should be used.

■ Embroidery Needles



Use a 75/11 home sewing machine needle for embroidery. When embroidering patterns with short stitches, such as small letters, we recommend using a ball point needle for embroidery.

⚠ CAUTION

- The appropriate fabric, thread and needle combinations are shown in the preceding table. If the combination of the fabric, thread and needle is not correct, particularly when sewing heavy fabrics (such as denim) with thin needles (such as 65/9 to 75/11), the needle may break and cause injury. In addition, the stitching may be uneven or puckered or there may be skipped stitches.

CHANGING THE PRESSER FOOT



⚠ CAUTION

- Always touch  on the screen to lock all keys and buttons before changing the presser foot. If  is not touched and the “Start/ Stop” button or another button is pressed, the machine will start and may cause injury.
- Always use the correct presser foot for the selected stitch pattern. If the wrong presser foot is used, the needle may strike the presser foot and break, and may cause injury.
- Make sure that the presser foot is installed in the correct direction, otherwise the needle may strike the presser foot, breaking the needle and causing injuries.

IMPORTANT

- Use presser feet made for this machine.

Replacing the Presser Foot

- 1 Press  (Needle position button) to raise the needle.
- 2 Touch  to lock all keys and buttons.
 - * If the message [OK to automatically lower the presser foot?] appears on the LCD screen, touch  to continue.
- 3 Raise the presser foot lever.
- 4 Press the black button on the presser foot holder and remove the presser foot.

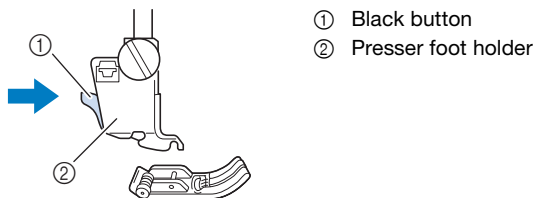

- ① Black button
- ② Presser foot holder

- 5 Place the new presser foot under the holder, aligning the foot pin with the notch in the holder. Lower the presser foot lever so that the presser foot pin snaps into the notch in the holder.

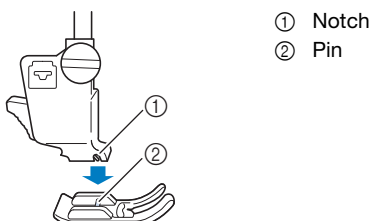

- ① Notch
- ② Pin

- 6 Raise the presser foot lever to check that the presser foot is securely attached.

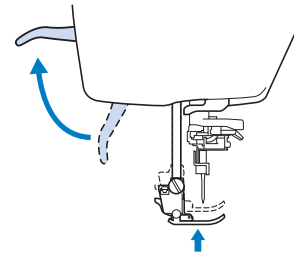

- 7 Touch  to unlock all keys and buttons.

Attaching the Presser Foot with the Included Adapter

Some presser feet require using the included adapter and small screw, for example, the free motion echo quilting foot “E” and so on.

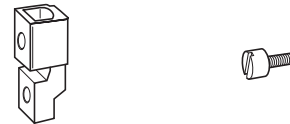

■ Attaching the Included Adapter and Small Screw

- 1 Follow the steps in “Replacing the Presser Foot” on page 45.
- 2 Loosen the screw of the presser foot holder to remove the presser foot holder.

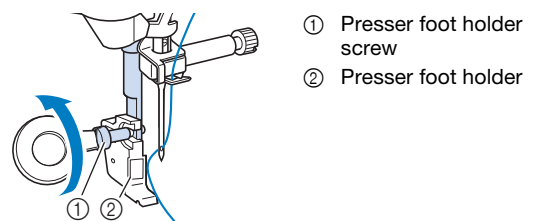

- ① Presser foot holder screw
- ② Presser foot holder

- 3 Remove the screw of the presser foot completely from the presser foot shaft.

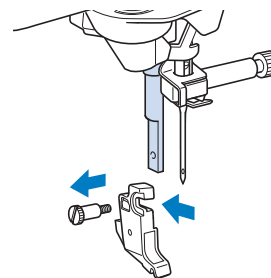

- 4 Set the adapter on the presser foot bar, aligning the flat side of the adapter opening with the flat side of the presser bar. Align the screw holes in the adapter and presser foot bar, and then securely tighten the screw with the disc-shaped screwdriver.

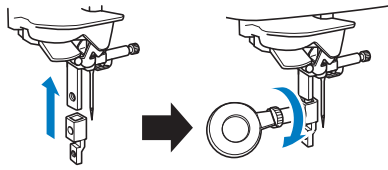

- 5 Turn the included small screw 2 or 3 times with your hand.

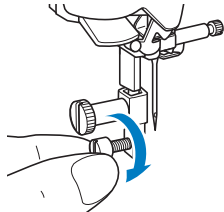

- 6 Touch  to unlock all keys and buttons.

Using the Compact Dual Feed Foot

The compact dual feed foot enables you to have best fabric control when sewing difficult fabrics that slip easily, such as quilted fabrics or fabrics that tend to stick to the bottom of a presser foot, such as vinyl, leather or synthetic leather.

 **Note**

- When sewing with the compact dual feed foot, sew at medium to low speeds.

 **Memo**

- When selecting stitches to be used with the compact dual feed foot, only the stitches that can be used will be activated on the display.
- When sewing fabric that easily sticks together, a more attractive finish can be achieved by basting the beginning of sewing.

■ Attaching the Compact Dual Feed Foot

- 1 Remove the presser foot. (page 45)
- 2 Loosen the screw of the presser foot holder to remove the presser foot holder.

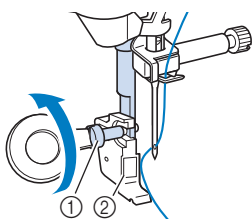

- ① Presser foot holder screw
- ② Presser foot holder

- 3 Position the compact dual feed foot to the presser foot bar by aligning the notch of the compact dual feed foot to the large screw.

Side view

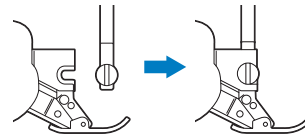

- 4 Hold the compact dual feed foot in place with your right hand, then using the disc-shaped screwdriver securely tighten the large screw.

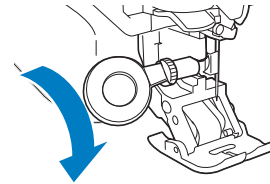

CAUTION

- Use the included screwdriver to firmly tighten the screw. If the screw is loose, the needle may strike the presser foot and possibly cause injury.

- 5 Plug the connector of the compact dual feed foot into the jack on the back of your machine.

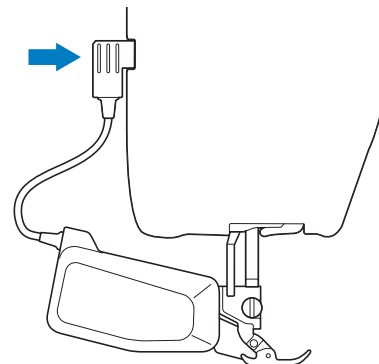

- 6 Touch  to unlock all keys and buttons.

→ All keys and operation buttons are unlocked, and the previous screen is displayed.

- 7 Place the fabric under the compact dual feed foot with the needle at the starting point of the stitching.

- 8 Be sure that the feed position lever is pushed down and the compact dual feed foot is ready to sew.

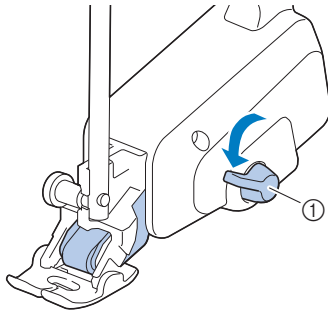

① Feed position lever

Note

- Do not operate the lever while sewing.

Memo

- When the feed position lever is up, dual feed function is not effective. When the feed position lever is down, the black roller belt on the compact dual feed is engaged.

Attaching/Detaching Toe

Attach the toe by aligning the pins with the notches and snap it into place.

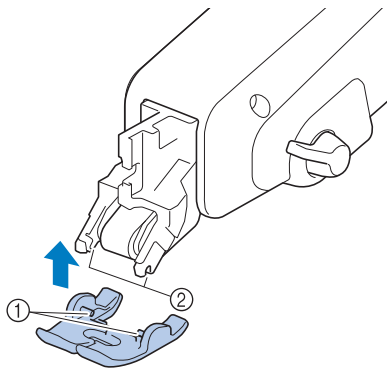

① Pins
② Notches

If you push down on the front and back part of the compact dual feed foot, the toe of the compact dual feed foot will snap off.

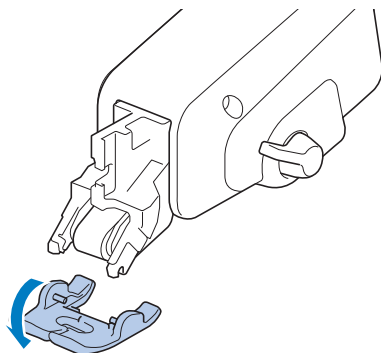

Adjusting the Amount of Fabric Feeding from the Compact Dual Feed Foot

The dual feed mechanism pulls the top fabric according to the set stitch length. With troublesome fabrics, fine tune the set length, by changing [Dual Feed Feed Adjustment] in the settings screen.

Note

- As a default, some keys mentioned in the following procedures appear in light gray and are not available. To enable the keys for specifying the settings, attach the compact dual feed foot to the machine. The keys are enabled after the compact dual feed foot is detected.

- 1 Touch .

→ The settings screen appears.

- 2 Touch .

→ The sewing settings screen appears.

- 3 Display [Dual Feed Feed Adjustment] in the sewing settings screen.



- 4 Use or to increase or decrease the feeding of the top fabric.

- * Select [00] for sewing in most cases.
- * If the feed amount for the top fabric is too little, causing the fabric to be longer than the bottom fabric, touch to increase the feed amount for the top fabric.
- * If the feed amount for the top fabric is too much, causing the fabric to be shorter than the bottom fabric, touch to decrease the feed amount for the top fabric.

- 5 Touch to return to the original screen.

Chapter 2 SEWING BASICS

2

SEWING BASICS

SEWING

CAUTION

- To avoid injury, pay special attention to the needle while the machine is in operation. Keep your hands away from moving parts while the machine is in operation.
- Do not stretch or pull the fabric during sewing. Doing so may lead to injury.
- Do not use bent or broken needles. Doing so may lead to injury.
- Do not attempt to sew over basting pins or other objects during sewing. Otherwise, the needle may break and cause injury.

IMPORTANT

- If stitches become bunched, lengthen the stitch length setting before continuing sewing. Otherwise, the needle may break and cause injury.

Stitch Types

Utility Stitches

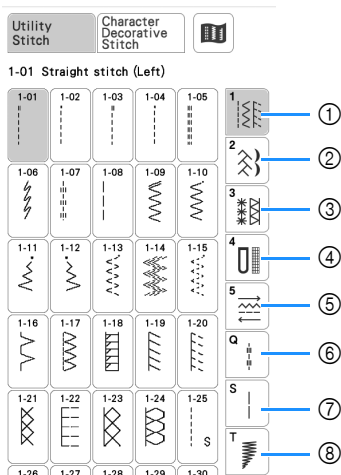

- 1 Straight/Overcasting
- 2 Decorative Stitches
- 3 Heirloom Stitches
- 4 Buttonholes/Bar tacks
- 5 Multi-directional
- 6 Sewing Quilting Stitches
- 7 Other Stitches
- 8 Stitch Tapering

Character/Decorative Stitches

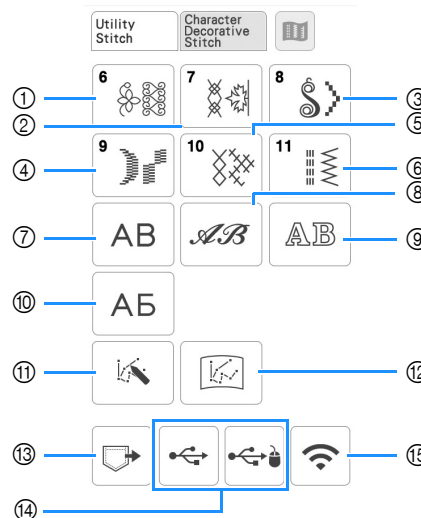



- ① Decorative stitch patterns
- ② 7mm decorative stitch patterns
You can set stitch length and width.
- ③ Satin stitch patterns
- ④ 7mm satin stitch patterns
You can set stitch length and width.
- ⑤ Cross stitch
- ⑥ Utility decorative stitch patterns
- ⑦ Alphabet characters (gothic font)
- ⑧ Alphabet characters (handwriting font)
- ⑨ Alphabet characters (outline)
- ⑩ Cyrillic font
- ⑪ MY CUSTOM STITCH (page 99)
You can design original stitches.
- ⑫ Stitch patterns stored in MY CUSTOM STITCH (page 101)
- ⑬ Stitch patterns saved in the machine's memory (page 97)
- ⑭ Stitch patterns saved in USB media (page 97)
- ⑮ Stitch patterns to be transferred via the wireless network (page 97)

Basic Sewing

Note

- First, perform a trial sewing, using a piece of fabric and thread that are the same as those used for your project.

- 1 Turn the main power to ON and touch  to display the utility stitches, and press  (Needle position button) to raise the needle.

2 Select the category you want.

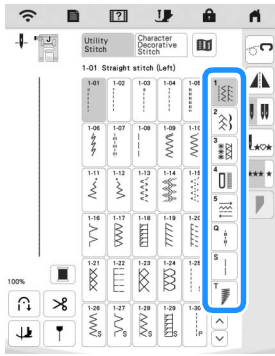

3 Touch the key of the stitch you want to sew.

- For details on stitch patterns, refer to “STITCH SETTING CHART” on page 197.
- For details on the key functions, refer to “Key Functions” on page 18.
- If necessary, change to the desired stitch width or stitch length. (page 57)

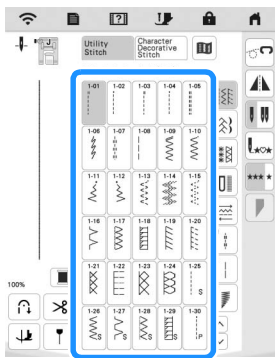

→ The symbol of the correct presser foot will be displayed in the upper left corner of the LCD screen.

4 Install the presser foot (page 45).

! CAUTION

- Always use the correct presser foot. If the wrong presser foot is used, the needle may strike the presser foot and break, possibly resulting in injury. Refer to “STITCH SETTING CHART” on page 197 for presser foot recommendations.

5 Set the fabric under the presser foot. Hold the fabric and thread in your left hand, and rotate the handwheel counterclockwise or press  (Needle position button) to set the needle in the sewing start position.

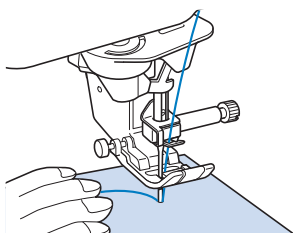

6 Lower the presser foot.

* You do not have to pull up the bobbin thread.

7 Adjust the sewing speed with the speed control slide.

* You can use this slide to adjust sewing speed during sewing.

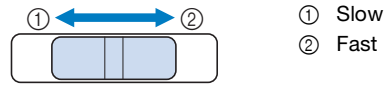

8 Press the “Start/Stop” button to start sewing.

* Guide the fabric lightly by hand.

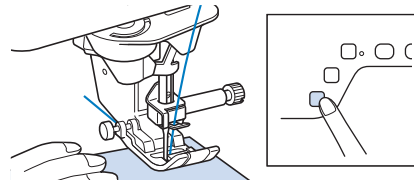

Memo

- When the foot controller is being used, you cannot start sewing by pressing the “Start/Stop” button.

9 Press the “Start/Stop” button again to stop sewing.

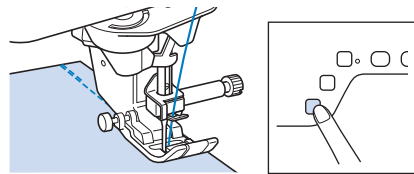

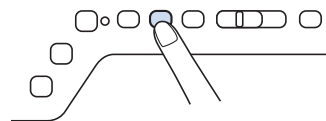

10 Press  (Thread cutter button) to trim the upper and bobbin threads.



→ The needle will return to the up position automatically.

IMPORTANT

- Do not press  (Thread cutter button) after the threads have been cut. Doing so could tangle the thread or damage the machine.
- Do not press  (Thread cutter button) when there is no fabric set in the machine or during machine operation. The thread may tangle, possibly resulting in damage.

Note

- When cutting thread thicker than #30, nylon monofilament thread, or other decorative threads, use the thread cutter on the side of the machine.

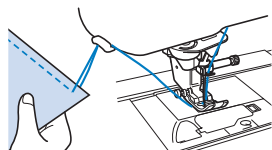

- When the needle has stopped moving, raise the presser foot and remove the fabric.

Using the Foot Controller

You can also use the foot controller to start and stop sewing.

Memo

- When the foot controller is connected, the “Start/Stop” button cannot be used to start sewing.
- The foot controller cannot be used when embroidering.

- Turn off the machine.
- Insert the foot controller plug into the foot controller jack on the machine.

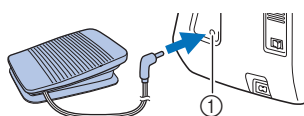

① Foot controller jack

- Turn on the machine.
- Slowly depress the foot controller to start sewing.

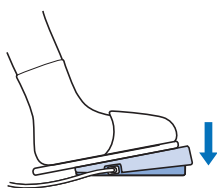
**Memo**

- The speed that is set using the sewing speed controller will be the foot controller's maximum sewing speed.

- Release the foot controller to stop the machine.

Using Advanced Multi-Function Foot Controller (Included with Some Models)

With the advanced multi-function foot controller, various sewing machine operations in addition to starting/stopping sewing, such as thread cutting and reverse stitching, can be specified to be performed.

WARNING

- The advanced multi-function foot controller contains small parts. Keep the product out of the reach of children to prevent accidental ingestion of small parts.

Note

- (For U.S.A. only) Foot controller: Model X
This foot controller can be used on the machine with product code 882-W73. The product code is mentioned on the machine rating plate.

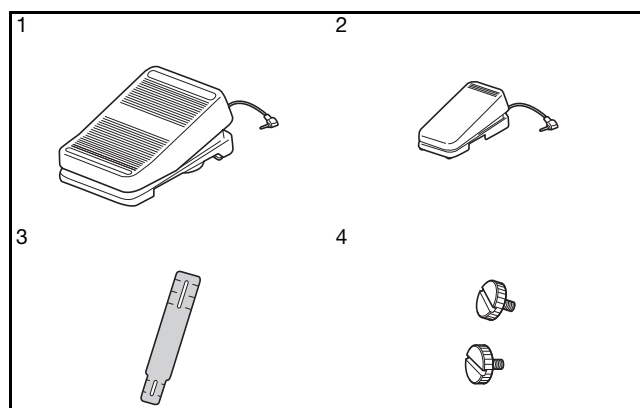

No.	Part Name
1	Main foot controller
2	Side pedal
3	Mounting plate
4	Mounting screw × 2

- Align the smaller end of the mounting plate with the guide on the bottom of the side pedal, and then gently fasten them together with the mounting screw. Align the larger end of the mounting plate with the guide on the bottom of the main foot controller, and then gently fasten them together with the mounting screw.

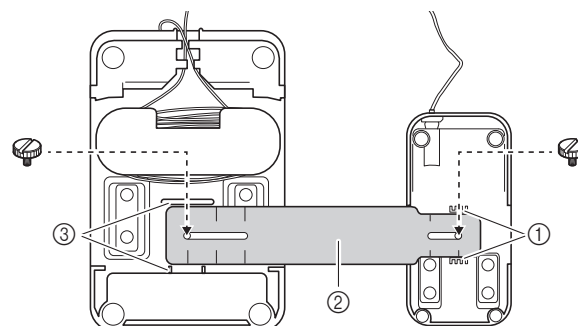

- Guide on side pedal
- Mounting plate
- Guide on main foot controller

Memo

- The side pedal can be mounted on either the left or right side of the main foot controller.
- The main foot controller and side pedal can also be used without installing the mounting plate.

2 Adjust the spacing between the main foot controller and side pedal.

* Use the markings on the mounting plate as a convenient guide to adjust the spacing.

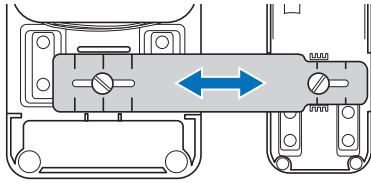

3 Firmly tighten the mounting screws to secure the main foot controller and side pedal.

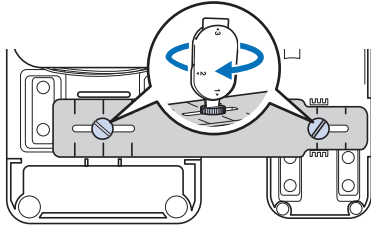

Memo

• To readjust the spacing between the main foot controller and side pedal, slightly loosen the mounting screws, and then adjust the positions of the main foot controller and side pedal.

4 Turn off the machine.

5 Insert the plug for the side pedal into the jack on the main foot controller.

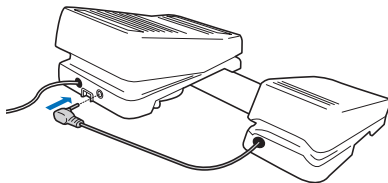

6 Insert the plug for the main foot controller into the foot controller jack on the right side of the machine.

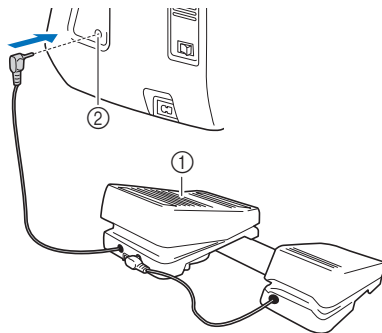

- ① Main foot controller
- ② Foot controller jack

Memo

• The length of the cord for the main foot controller can be adjusted. (page 53)

7 Turn on the machine. And then touch and display page 2 of the settings screen.

Memo

• Before specifying the functions, connect the multi-function foot controller to the machine. The settings screen is activated the first time that the machine detects the multi-function foot controller.

8 Select the functions to be performed by the multi-function foot controller.

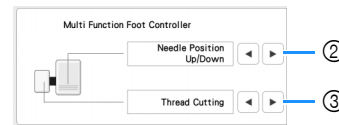
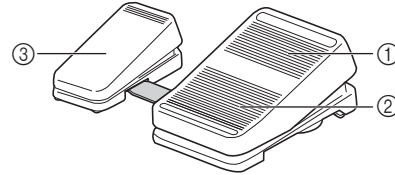

	Controller	Functions that can be specified
①	Main foot controller	Start/Stop
②	Heel switch	Select any of the following: <ul style="list-style-type: none"> • [Thread Cutting] • [Needle Position – Up/Down] • [Single Stitch] • [Reverse Stitch] (Reinforcement Stitch) * • [Presser Foot Up/Down] • [No Setting]
③	Side pedal	

- * If you set the “Reverse Stitch” function on the heel switch, machine operates the same as pressing (Reverse stitch button) on the machine.
- * Reinforcement stitching may be applied depending on the selected stitch pattern. For the details, refer to “Automatic Reverse/Reinforcement Stitching” on page 55.

Memo

• If you set [Reverse Stitch] on the side pedal, you can create a darning stitch effect using zigzag stitches. With both feet, keep pressing the main foot controller, and repeat pressing and releasing the side pedal to sew forward and reverse in turn. Machine will reverse at the speed you press the main foot controller.

9 Touch .

10 Sew trial stitches and confirm that the settings are as desired.

Pressing down on the main foot controller increases the sewing speed; releasing the pressure on the main foot controller decreases the sewing speed.

Release the main foot controller or side pedal to stop sewing.

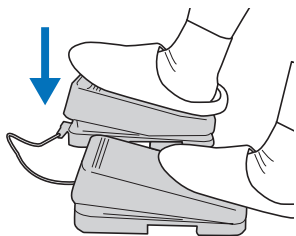

Memo

- The speed that is set using the sewing speed controller will be the main foot controller's maximum sewing speed.
- When the multi-function foot controller is connected, the "Start/Stop" button cannot be used to start sewing.

■ Adjusting the Length of the Cord for the Main Foot Controller

1 Unwind the cord for the main foot controller.

2 Guide the cord between the tabs.

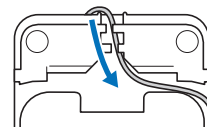

3 Wind the cord until it is the desired length.

- * The cord can be wound either clockwise or counterclockwise.

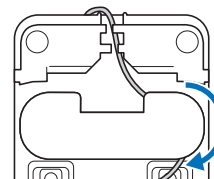

4 Pass the cord between the tabs.

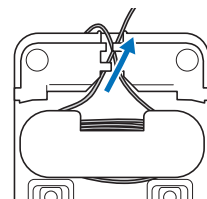

Note

- In order to avoid stepping on the cord with the main foot controller, pass the cord between the tabs.

Memo

- When storing the cord, pass it between the tabs, and then insert the plug into the jack on the main foot controller.

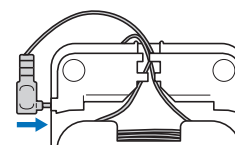

Combining Stitch Patterns

Stitch patterns from the following categories can be combined.

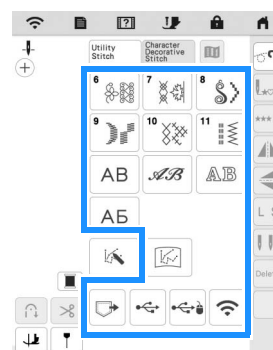

Example:



1 Touch .

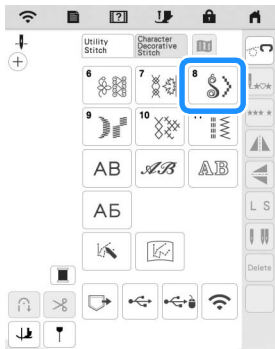

2 Select the following stitch pattern (8-35).

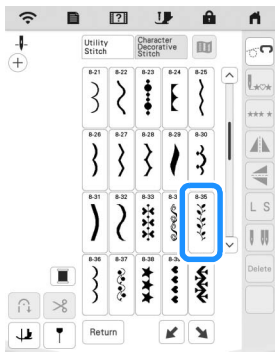

3 Touch so that it displays .

4 Touch .

→ The display returns to the stitch selection screen.

5 Select a font.



6 Enter characters.

- : Select a stitch pattern individually.
- : Delete the selected stitch pattern.
- : Enter a space.

7 If you want to sew the stitch pattern continuously,

touch .



→ The stitch pattern turns continuous.

Memo

- When sewing is completed, trim any excess thread between characters.



Inserting Stitch Patterns

1 Touch or to select the stitch pattern at the position where a new stitch pattern will be added.

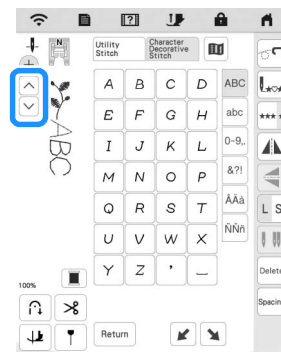

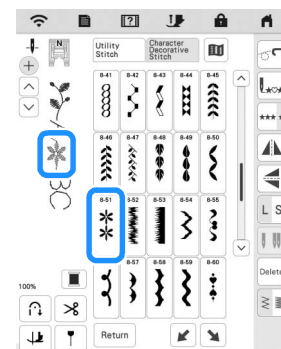

2 Touch .

3 Select a new stitch pattern.



→ The new stitch pattern is added immediately after the stitch pattern selected in step 1.

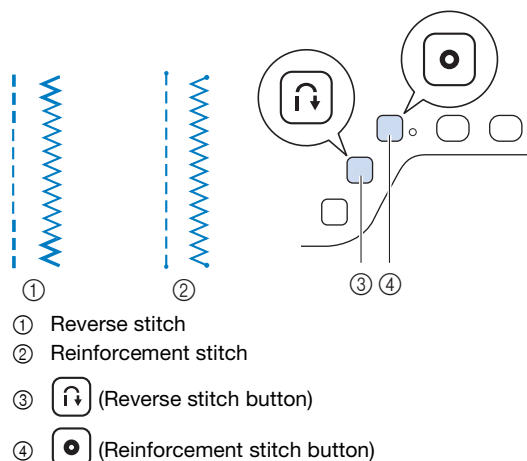

Sewing Reverse Stitches/Reinforcement Stitches

Reverse/reinforcement stitches are generally necessary at the beginning and end of sewing. You can use  (Reverse stitch button) to sew reverse/reinforcement stitches. When you keep pressing , the machine will sew reinforcement stitch at that point 3 to 5 stitches, and then stop. (page 10)



The operation performed when the button is pressed differs depending on the selected stitch pattern. (Refer to “STITCH SETTING CHART” on page 197.)

Memo

- When you press  (Reinforcement stitch button) while sewing character/decorative stitch pattern, you can end sewing with a full stitch instead of at a mid-point.
- The green light on the right of  (Reinforcement stitch button) lights up while the machine is sewing a full motif, and it automatically turns off when the sewing is stopped.

Automatic Reverse/Reinforcement Stitching

After selecting a stitch motif, turn on the automatic reinforcement stitching function before sewing, and the machine will automatically sew reinforcement stitches (or reverse stitches, depending on the stitch motif) at the beginning and end of sewing.

1 Select a stitch pattern.

2 Touch  to set the automatic reinforcement stitching function.

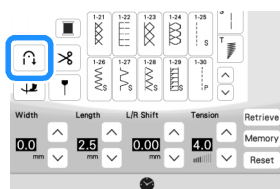

→ The key will display as .

3 Set the needle in the start position and press the “Start/Stop” button to start sewing.

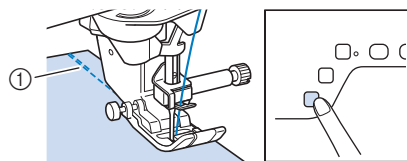



① Reverse stitches (or reinforcement stitches)

→ The machine will automatically sew reverse stitches (or reinforcement stitches) and then continue sewing.

Memo

- Pressing the “Start/Stop” button while the machine is sewing pauses or restarts sewing.



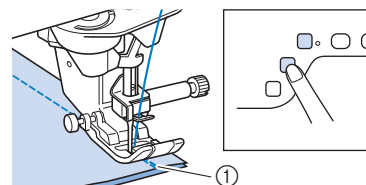









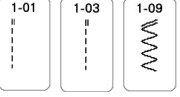



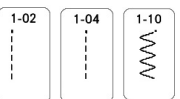





4 Press  (Reverse stitch button) or  (Reinforcement stitch button).











① Reverse stitches (or reinforcement stitches)

→ The machine will sew reverse stitches (or reinforcement stitches) and stop.

The operation performed when the button is pressed differs depending on the selected stitch pattern. Refer to the following table for details on the operation that is performed when the button is pressed.

	 (Reverse stitch button)	 (Reinforcement stitch button)
Utility Stitch +  	Machine sews reverse stitches while holding  (Reverse stitch button).	Machine sews 3 – 5 reinforcement stitches while holding  (Reinforcement stitch button).
Utility Stitch +  	Machine sews reverse stitches while holding  (Reverse stitch button).*	Machine sews 3 – 5 reinforcement stitches while holding  (Reinforcement stitch button).
 with a stitch other than reverse or reinforcement stitch pattern selected.	Machine sews 3 – 5 reinforcement stitches while holding  (Reverse stitch button).	Machine sews 3 – 5 reinforcement stitches while holding  (Reinforcement stitch button).
Character Decorative Stitch + 	Machine sews reinforcement stitches while holding  (Reverse stitch button).	Machine sews reinforcement stitches after completing the stitch pattern, when  (Reinforcement stitch button) is pressed.
Utility Stitch +  	Machine sews reverse stitches and stops sewing when the  (Reverse stitch button) is pressed. (At the beginning of sewing, reverse stitches are sewn automatically when “Start/Stop” button is pressed.)	Machine sews reinforcement stitches and stops sewing when  (Reinforcement stitch button) is pressed. (At the beginning of sewing, reverse stitches are sewn automatically when “Start/Stop” button is pressed.)
Utility Stitch +  	Machine sews reverse stitches and stops sewing when  (Reverse stitch button) is pressed.* (At the beginning of sewing, reinforcement stitches are sewn automatically when “Start/Stop” button is pressed.)	Machine sews reinforcement stitches and stops sewing when  (Reinforcement stitch button) is pressed. (At the beginning of sewing, reinforcement stitches are sewn automatically when “Start/Stop” button is pressed.)

	 (Reverse stitch button)	 (Reinforcement stitch button)
 with a stitch other than reverse or reinforcement stitch pattern selected.	Machine sews reinforcement stitches and stops sewing when  (Reverse stitch button) is pressed. (At the beginning of sewing, reinforcement stitches are sewn automatically when “Start/Stop” button is pressed.)	Machine sews reinforcement stitches and stops sewing when  (Reinforcement stitch button) is pressed. (At the beginning of sewing, reinforcement stitches are sewn automatically when “Start/Stop” button is pressed.)
Character Decorative Stitch + 	Machine sews reinforcement stitches and stops sewing when  (Reverse stitch button) is pressed. (At the beginning of sewing, reinforcement stitches are sewn automatically when “Start/Stop” button is pressed.)	Machine sews reinforcement stitches and stops sewing after completing the stitch pattern, when  (Reinforcement stitch button) is pressed. (At the beginning of sewing, reinforcement stitches are sewn automatically when “Start/Stop” button is pressed.)

* If [Reinforcement Priority] of the settings screen is set to [ON] (page 20), reinforcement stitches are sewn instead of reverse stitches.

Automatic Presser Foot Lowering Function and Thread Cutting Function

By setting the machine to automatically raise and lower the presser foot, sewing operations can be performed more smoothly.

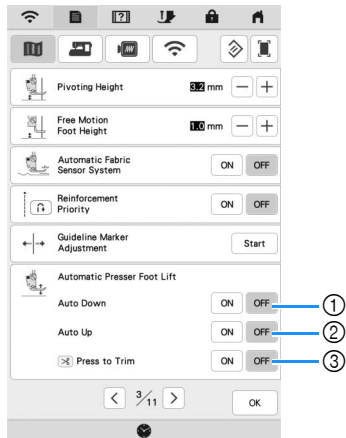

No.	Key Name	Explanation
①	[Auto Down]	When [Auto Down] is set to [ON], pressing the "Start/Stop" button or depressing the foot controller automatically lowers the presser foot (if it is raised) before starting to sew.
②	[Auto Up]	When [Auto Up] is set to [ON], the presser foot is raised when stopping sewing. The presser foot is raised to the height specified for [Presser Foot Height] (page 20). When the pivot setting () is selected, the presser foot is raised to the height specified for [Pivoting Height] (page 20).
③	[Press to Trim]	When [Press to Trim] is set to [ON], pressing (Thread cutter button) automatically lowers the presser foot (if it is raised) before cutting the thread. The presser foot will be raised after the thread is cut.

STITCH SETTINGS

Setting the Stitch Width/Stitch Length/"L/R Shift"

When you select a stitch, your machine automatically selects the appropriate stitch width, stitch length, and L/R Shift. However, if needed, you can change any of the individual settings.

Memo

- Settings for some stitches cannot be changed (page 197).
- If you turn off the machine or select another stitch without saving stitch setting changes (page 59), the stitch settings will return to their default settings.
- Touch **Memory** to save the stitch settings.
- Touch to check changes made to the stitch.
- Touch **Reset** to return the original setting.

Note

- After adjusting the stitch width or the "L/R Shift", slowly turn the handwheel toward you (counterclockwise) and check that the needle does not touch the presser foot.

IMPORTANT

- **If the stitches get bunched together, lengthen the stitch length and continue sewing. Do not continue sewing without lengthening the stitch length. Otherwise, the needle may bend or break.**

Setting the Stitch Width

Follow the steps below when you want to change the zigzag stitch pattern width.

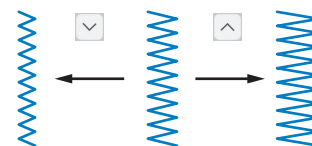

Memo

- For an alternate method of changing the stitch width using the speed controller, refer to page 75.

■ Setting the Stitch Length

Follow the steps below when you want to change the stitch pattern length.



■ Setting the "L/R Shift"

Follow the steps below when you want to change the placement of the zigzag stitch pattern by moving it left and right.

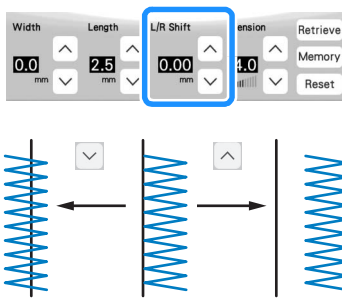

Setting the Thread Tension

You may need to change the thread tension, depending on the fabric and thread being used. Follow the steps below to make any necessary changes.



Memo

- Touch **Reset** to return the thread tension to the original setting.

■ Proper Thread Tension

The upper thread and the bobbin thread should cross near the center of the fabric. Only the upper thread should be visible from the right side of the fabric, and only the

bobbin thread should be visible from the wrong side of the fabric.

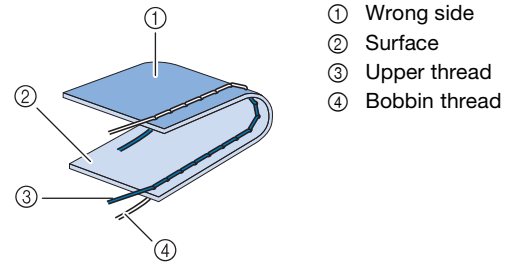

- ① Wrong side
- ② Surface
- ③ Upper thread
- ④ Bobbin thread

Memo

- Many decorative stitches and satin stitches are designed so that the upper thread wraps to the back slightly for a more attractive finish.

■ Upper Thread is Too Tight

If the bobbin thread is visible from the right side of the fabric, the upper thread is too tight.

Note

- If the bobbin thread was incorrectly threaded, the upper thread may be too tight. In this case, refer to "Setting the Bobbin" on page 34 and rethread the bobbin thread.

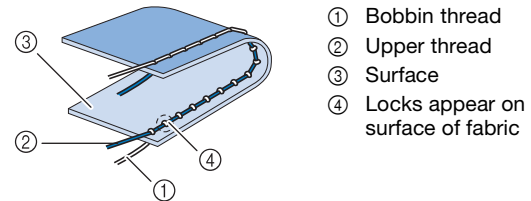

- ① Bobbin thread
- ② Upper thread
- ③ Surface
- ④ Locks appear on surface of fabric

Touch **▽**, to loosen the upper thread.

■ Upper Thread is Too Loose

If the upper thread is visible from the wrong side of the fabric, the upper thread is too loose.

Note

- If the upper thread was incorrectly threaded, the upper thread may be too loose. In this case, refer to "Upper Threading" on page 36 and rethread the upper thread.

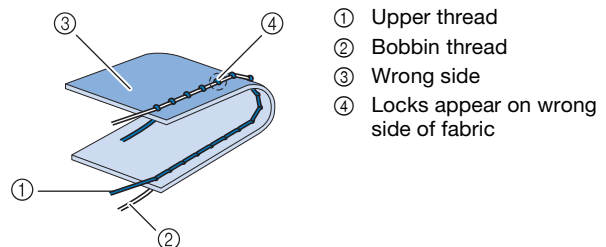

- ① Upper thread
- ② Bobbin thread
- ③ Wrong side
- ④ Locks appear on wrong side of fabric

Touch **△**, to tighten the upper thread.

Saving Your Stitch Settings

The settings for the zigzag stitch width, stitch length, thread tension, etc., are preset in the machine for each stitch. However, if you have specific settings that you wish to reuse later for a stitch, you can change the settings so that they can be saved for that stitch. Five sets of settings can be saved for a single stitch.

■ Saving Settings

- 1 Select a stitch.
- 2 Specify your preferred settings.



- 3 Touch **Memory**.



→ The settings are saved and the original screen automatically appears.

📝 Memo

- If you try to save settings when there are already 5 sets of settings saved for a stitch, delete a setting referring to “Retrieving Saved Settings” on page 59.

■ Retrieving Saved Settings

- 1 Select a stitch.
- 2 Touch **Retrieve**.
- 3 Touch the numbered key of the settings to be retrieved.

* Touch **Cancel** to return to the original screen without retrieving settings.

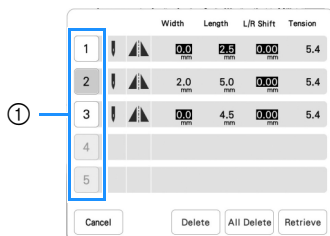

① Numbered keys

- 4 Touch **Retrieve**.

→ The selected settings are retrieved, and the original screen automatically appears.

📝 Memo

- To save new settings when there are already 5 sets of settings saved for a stitch, touch **Retrieve**. Touch the numbered key of the setting to be deleted.

Touch **Delete**, touch **OK** and then **Memory**. The new setting will be saved in place of the recently deleted setting.

- You can delete all the saved settings by touching

All Delete.

■ Returning the Selected Stitch Pattern Saved Settings to the Default Settings

- 1 Touch **Reset**.



- 2 Touch **Memory**.



USEFUL FUNCTIONS

Automatic Thread Cutting

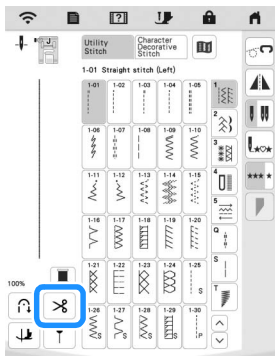

After selecting a stitch pattern, turn on the automatic thread cutting function before sewing, and the machine will automatically sew reinforcement stitches (or reverse stitches, depending on the stitch pattern) at the beginning and end of sewing, and trim the threads at the end of sewing. This function is useful when sewing buttonholes and bar tacks.

- 1 Select a stitch pattern.
- 2 Touch  to set the automatic thread cutting function.





→ The keys will display as  , and the machine is set for automatic thread cutting function and automatic reverse/reinforcement stitching.

Memo

- To turn off the automatic thread cutting function, touch  again, so it appears as .

- 3 Set the needle into the fabric and start sewing.
→ The machine will automatically sew reverse stitches (or reinforcement stitches) and then continue sewing.

- 4 Once you have reached the end of the stitching, press  (Reverse stitch button) or  (Reinforcement stitch button) once.

If stitching, such as buttonholes and bar tacking, that includes reinforcement stitching has been selected, this operation is unnecessary.

→ After the reverse stitching (or reinforcement stitching) has been done, the machine stops, and the threads are cut.

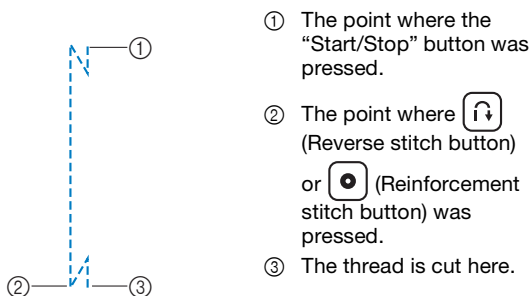

Adjusting the Needle Drop Point with the Guideline Marker

The red guideline marker indicates the sewing position on the fabric. You can adjust the sewing position by moving the guideline marker while checking the guideline marker on the fabric.

WARNING

- The guideline marker is a laser; therefore, do not stare at the laser light directly. Otherwise it may cause blindness.

- 1 Touch  to display the guideline marker.

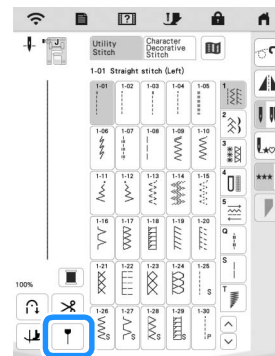

→ The guideline marker scale appears.

- * Depending on the setting of [Initial Position] in the settings screen, the initial needle drop point is scaled as either 0.0 mm or 3.5 mm.

- 2 Use  or  to move the needle drop point.

→ Adjust the position from 15.5 mm (approx. 5/8 inch) to the right of the left needle to -3.5 mm (approx. -1/8 inch) to the left of the left needle.





- 1 Touch to flip the guideline marker position on the center needle position.

- 3 Touch  again to stop using the guideline marker.

■ Adjusting the Guideline Marker Position

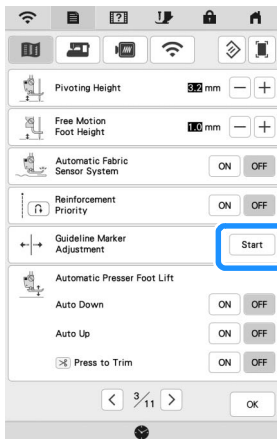

If the guideline marker indicates the position incorrectly in the center needle position, adjust the initial position in the settings screen.

- 1 Touch .
→ The settings screen appears.
- 2 Touch .
→ The sewing settings screen appears.
- 3 Display [Guideline Marker Adjustment] in the sewing settings screen.
- 4 Touch .





- 5 Use  or  to adjust the guideline marker position.



- *  : Move the guideline marker to the left.
 : Move the guideline marker to the right.

- 6 Touch  twice to return to the original screen.

■ Adjusting the Brightness of the Guideline Marker

- 1 Follow steps from 1 to 4 to display the [Guideline Marker Adjustment] screen.
- 2 Use  or  to adjust the brightness of the guideline marker.
→ Set the brightness of the guideline marker from [1] for a dim marker, to [5] for the brightest marker, on the fabric.



- 3 Touch  twice to return to the original screen.



Pivoting

If the pivot function is selected, the machine stops with the needle lowered (in the fabric) and the presser foot is automatically raised to an appropriate height when the "Start/Stop" button is pressed. When the "Start/Stop" button is pressed again, the presser foot is automatically lowered and sewing continues. This function is useful for stopping the machine to rotate the fabric.

⚠ CAUTION

- When the pivot setting is selected, the machine starts when the "Start/Stop" button is pressed or the foot controller is pressed down even if the presser foot has been raised. Be sure to keep your hands and other items away from the needle, otherwise injuries may occur.

Memo

- When the pivot setting is selected, the height of the presser foot when sewing is stopped can be changed according to the type of fabric being sewn. Touch  to display [Pivoting Height] of the settings screen. Touch  or  to select the height. To raise the presser foot further, increase the setting.



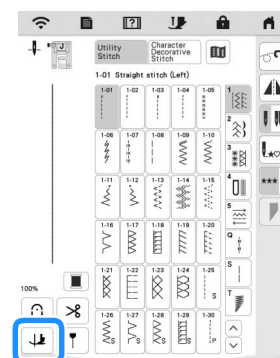

- 1 Select a stitch.

- 2 Touch  to select the pivot setting.



→ The key appears as .

Memo

- If  appears as light gray when the stitch pattern was selected, the pivot function cannot be used.
- If the pivot function is selected,  and  beside [Presser Foot Height] in the settings screen are not available and the setting cannot be changed.

- 3 Place the fabric under the presser foot with the needle at the starting point of the stitching, and then press the "Start/Stop" button. The machine will begin sewing.
- 4 Press the "Start/Stop" button to stop the machine at the point where the sewing direction changes.
→ The machine stops with the needle in the fabric, and the presser foot is raised.
- 5 Rotate the fabric, and then press the "Start/Stop" button.

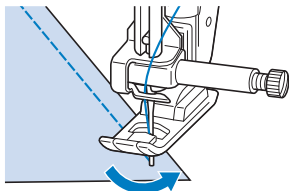

→ The presser foot is automatically lowered, and sewing continues.

Using the Knee Lifter

Using the knee lifter, you can raise and lower the presser foot with your knee, leaving both hands free to handle the fabric.

- 1 Align the tabs on the knee lifter with the notches in the knee lifter slot on the front of the machine. Insert the knee lifter bar as far as possible.

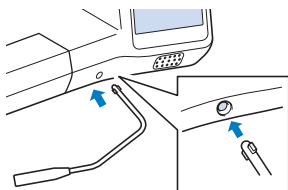

Memo

- If the knee lifter bar is not pushed into the mounting slot as far as possible, it may come out during use.

- 2 Use your knee to move the knee lifter bar to the right in order to raise the presser foot. Slowly return the knee lifter bar to the left to lower the presser foot.

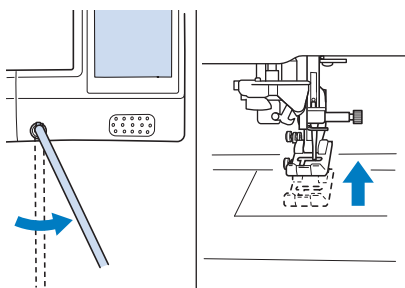

Note

- Be sure to keep your knee away from the knee lifter during sewing.



Automatic Fabric Sensor System (Automatic Presser Foot Pressure)

The thickness of the fabric is automatically detected and the presser foot pressure is automatically adjusted with an internal sensor while sewing, to insure that your fabric is fed smoothly. The fabric sensor system works continuously while sewing. This function is useful for sewing heavyweight fabrics (page 65), or quilting (page 74).

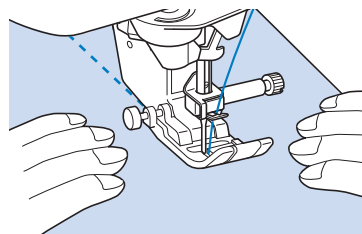
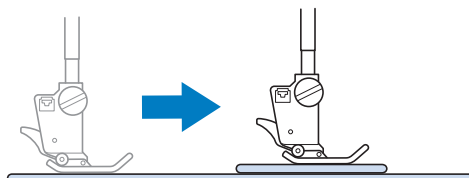
Touch , and then set [Automatic Fabric Sensor System] to [ON]. (page 20)





Needle Position - Stitch Placement

When the [Needle Position - Stitch Placement] is [ON], the needle will be partially lowered for precise stitch placement and then completely lowered when you press  (Needle Position button). Each press of  (Needle Position button) changes the needle to the next position. When the [Needle Position - Stitch Placement] is [OFF], each press of  (Needle Position button) simply raises and then lowers the needle.

Touch , and then set [Needle Position - Stitch Placement] to [ON] or [OFF]. (page 21)

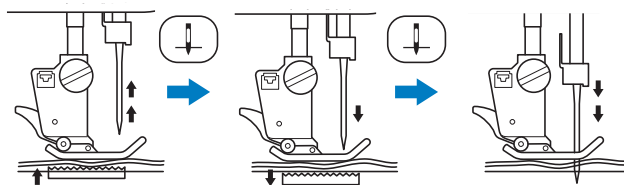
[Needle Position - Stitch Placement] is [ON]



- * When the needle is nearly lowered by pressing  (Needle position button), the feed dogs are lowered. At this time, the fabric can be shifted to finely adjust the needle drop point.

[Needle Position - Stitch Placement] is [OFF]

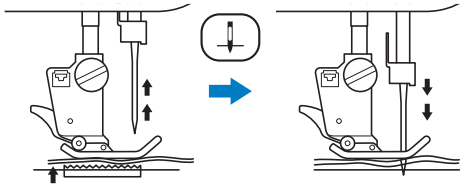

Using the Straight Stitch Needle Plate and the Straight Stitch Foot

The straight stitch needle plate and the straight stitch foot can only be used for straight stitches (middle needle position stitches). Use the straight stitch needle plate and the straight stitch foot when sewing thin fabrics or when sewing small pieces which tend to sink into the hole of the regular needle plate during sewing. The straight stitch foot is perfect to reduce puckering on lightweight fabrics. The small opening on the foot provides support for the fabric as the needle travels through the fabric.

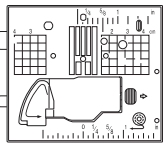
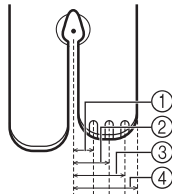

- ① 2.25 mm (1/8 inch)
- ② 4.25 mm (3/16 inch)
- ③ 6.25 mm (1/4 inch)
- ④ 8.5 mm (5/16 inch)

⚠ CAUTION

- Always use the straight stitch foot in combination with the straight stitch needle plate. Otherwise, the needle may break and cause injury.

- 1 Press  (Needle position button) to raise the needle, raise the presser foot and turn the main power to OFF. And then unplug the machine.
- 2 Remove the needle and the presser foot. (page 42, page 45)

- 3 Insert the multi-purpose screwdriver into the hole, and tilt the multi-purpose screwdriver to the left and then to the back, as shown in the illustration.

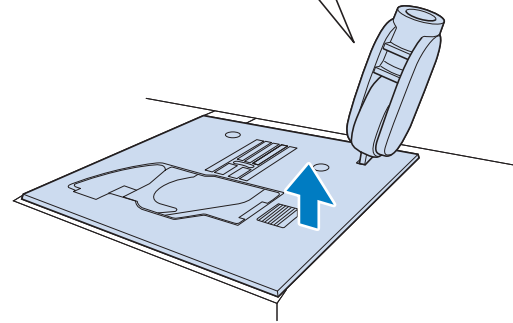
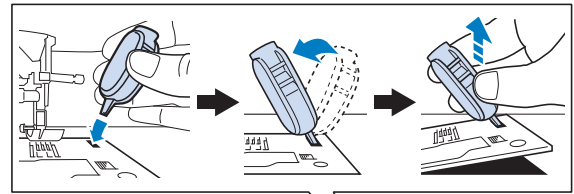

- 4 Slide out the regular needle plate with your right hand to remove it.

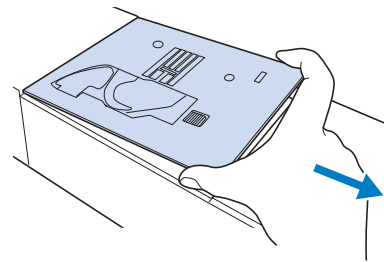

- 5 Insert the tabs on the straight stitch needle plate into the notches in the machine.

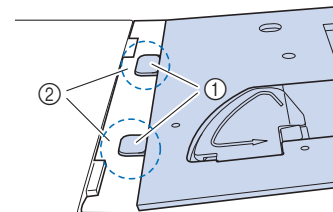

- ① Tabs
- ② Notches

- 6 Press down on the right side of the straight stitch needle plate to secure it.

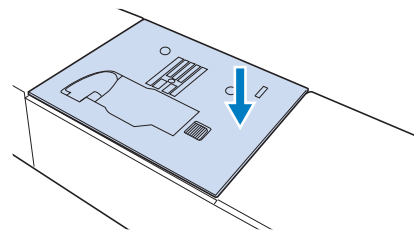

7 Insert needle and attach the straight stitch foot.

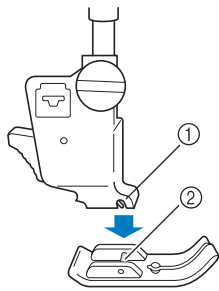

- ① Notch
- ② Pin

8 Select any of the straight stitches.

Memo

- Selecting unavailable stitches will cause an error message to be displayed.
- When the straight stitch needle plate is on the machine, the needle will automatically move to the middle position.

Note

- Slowly rotate the handwheel toward you (counterclockwise) before sewing and make sure that the needle is not contacting the straight stitch foot and straight stitch needle plate.

9 Start sewing.

- * After sewing, make sure to turn off the machine and to remove the straight stitch needle plate and the straight stitch foot. Reinstall the regular needle plate and the presser foot “J”.

USEFUL SEWING TIPS

Sewing Tips

■ Trial Sewing

Before starting your sewing project, we recommend sewing trial stitches using thread and scrap fabric that are the same as those used for your project. While checking the sewing results, adjust the thread tension as well as the stitch length and width according to the number of fabric layers and stitch that is sewn.

Note

- Other factors, such as fabric thickness, stabilizer material, etc., also have an effect on the stitch, so you should always sew a few trial stitches before beginning your project.
- When sewing satin stitch or 7 mm satin stitch patterns, there may be shrinking or bunching of stitches, so be sure to use a stabilizer material.

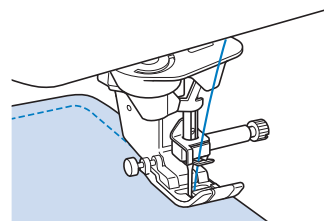

■ Sewing Curves

Sew slowly while keeping the seam parallel with the fabric edge as you guide the fabric around the curve.



Shorten the stitch length setting to obtain a fine stitch. Sew slowly, keeping the seams parallel with the fabric edge as you guide the fabric around the curve.

■ Changing Sewing Direction

Stop the machine. Leave the needle in the fabric, and press  (Presser foot lifter button) to raise the presser foot. Using the needle as a pivot, turn the fabric so that you can sew in the new direction. Press  (Presser foot lifter button) to lower the presser foot and start sewing.

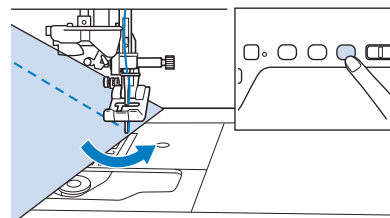

The pivot setting is useful when changing the sewing direction. (page 61)

Sewing Various Fabrics

■ Sewing Heavyweight Fabrics

If the thickness of a seam causes the presser foot to rest at an angle, help guide the fabric by hand and sew on the downward slope.

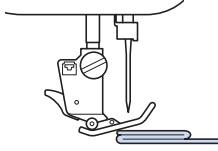

⚠ CAUTION

- If fabric more than 6 mm (approx. 1/4 inch) thick is sewn or if the fabric is pushed with too much force, the needle may break and cause injury.

📖 Memo

- Thicker fabrics require a larger needle. (page 44)

□ If the Fabric does not Fit under the Presser Foot

If the presser foot is in the up position, and you are sewing heavyweight or multiple layers of fabric which do not fit easily under the presser foot, use the presser foot lever to raise the presser foot to its highest position. The fabric will now fit under the presser foot.

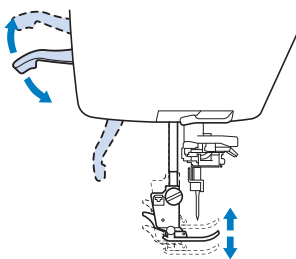

📖 Memo

- You cannot use the presser foot lever after the presser foot has been raised using  (Presser foot lifter button).

□ If the Fabric does not Feed

When sewing thick fabric such as denim or quilting layers, the fabric may not feed at the start of sewing if the presser foot is not level, as shown below. In this case, use the presser foot locking pin (black button on the left side) of zigzag foot "J" so that the presser foot remains level while sewing, allowing the fabric to be fed smoothly.

If the presser foot misalignment is too large, place thick paper or fabric (with the same thickness as the fabric being sewn) under the heel of the presser foot to be able to start sewing smoothly.

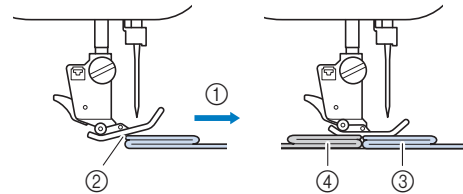

- ① Sewing direction
- ② Misalignment
- ③ Fabric being sewn
- ④ Fabric or thick paper

1 Raise the presser foot.

2 While keeping the black button on the left side of presser foot "J" pressed in, press (Presser foot lifter button) to lower the presser foot.

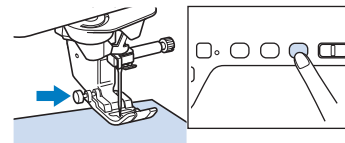

3 Release the presser foot locking pin.

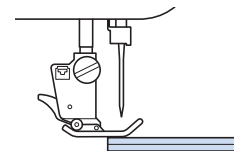

→ The presser foot remains level, enabling the fabric to be fed.

📖 Memo

- Once the trouble spot has been passed, the foot will return to its normal position.
- When [Automatic Fabric Sensor System] (Automatic Presser Foot Pressure) in the machine settings screen is set to [ON], the thickness of the fabric is automatically detected by the internal sensor so the fabric can be fed smoothly for best sewing results (page 62).

■ Sewing Lightweight Fabrics

Place thin paper or tear away embroidery stabilizer under thin fabrics to make sewing easier. Gently tear off the paper or the stabilizer after sewing.

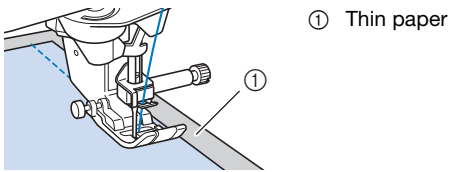

■ Sewing Stretch Fabrics

First, baste together the pieces of fabric, and then sew without stretching the fabric. In addition, a better result can be achieved by using thread for knits or a stretch stitch.

📌 Memo

- For best results when sewing stretch fabrics, decrease the pressure of the presser foot (page 20).

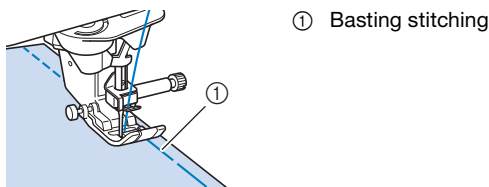

■ Sewing Leathers or Vinyl Fabrics

When sewing fabrics that may stick to the presser foot, such as leather or vinyl fabrics, replace the presser foot with the compact dual feed foot.

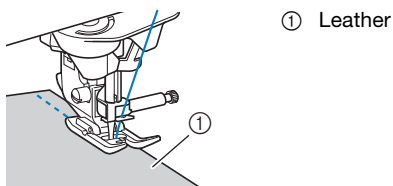

If the leather or vinyl fabric sticks to the flat bed attachment, sew with copy paper or tracing paper placed on top of the flat bed attachment so the fabric moves smoothly.

If the paper is positioned so that it does not cover the needle plate, the paper will not be sewn together with the fabric.

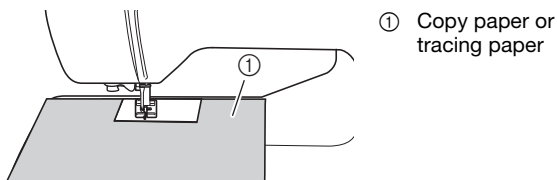

Sewing Decorative Stitch Patterns

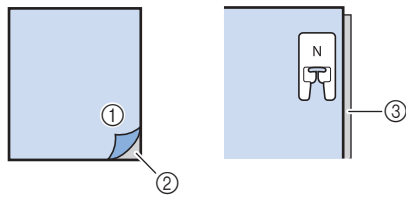
Fabric	When sewing on stretch fabrics, lightweight fabrics, or fabrics with coarse weaves, attach stabilizer on the wrong side of the fabric. An alternative would be to place the fabric on thin paper such as tracing paper.  ① Fabric ② Stabilizer ③ Thin paper
Thread	#50 - #60
Needle	With lightweight, regular, or stretch fabrics: the Ball point needle (golden colored) 90/14 With heavyweight fabrics: home sewing machine needle 90/14
Presser foot	Advanced monogramming foot "N+." Using another presser foot may give inferior results.

Chapter 3 VARIOUS STITCHES

UTILITY STITCHES

CAUTION

- Before replacing the presser foot, be sure to touch  to lock all keys and buttons, otherwise injuries may occur if the "Start/Stop" button or any other button is pressed and the machine starts. For details on changing the presser foot, refer to "Replacing the Presser Foot" on page 45.

Straight Stitches

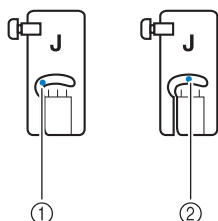
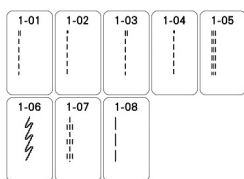

Memo

- For details on stitch patterns, refer to "STITCH SETTING CHART" on page 197.



- ① Left needle position
- ② Middle needle position

Changing the Needle Position (Left or Middle Needle Position Stitches Only)

When you select left or middle needle position stitches, you can use  and  in the L/R Shift display to change the position of the needle. Match the distance from the right edge of the presser foot to the needle with the L/R Shift, then align the edge of the presser foot with the edge of the fabric during sewing for an attractive finish.

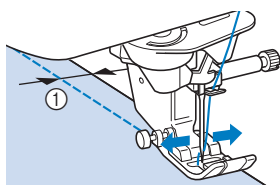

① L/R Shift

Example: Left/Middle needle position stitches

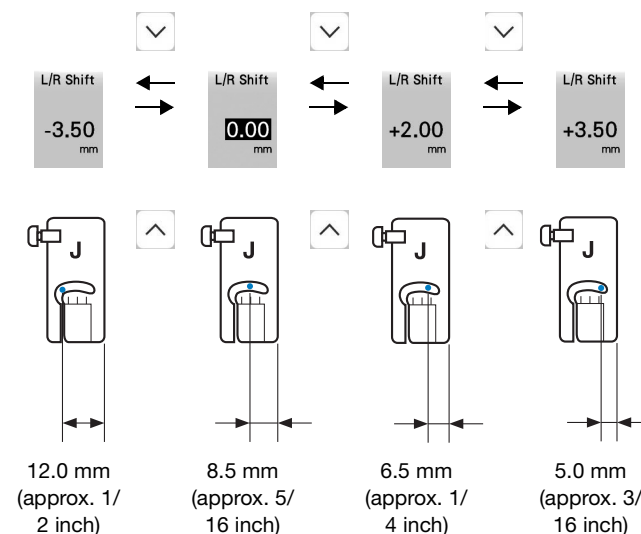

Memo

- Stitch Q-01 will not permit using the L/R Shift function.
- When [Width Control] in the Sewing settings screen is set to [ON], the needle position of a straight stitch can be changed with the sewing speed controller. And use the foot controller to operate the machine.

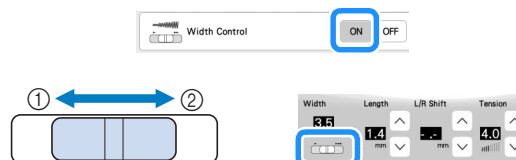

- ① Shift the needle position to the left.
- ② Shift the needle position to the right.

■ Aligning the Fabric with a Mark on the Needle Plate or Bobbin Cover (with Mark)

While sewing, align the edge of the fabric with the 5/8 inch (approx. 1.6 cm) mark on the needle plate or bobbin cover (with mark) depending on the needle position (left or middle (center) needle position stitches only).

For stitches with a left needle position (Stitch width: 0.0 mm)

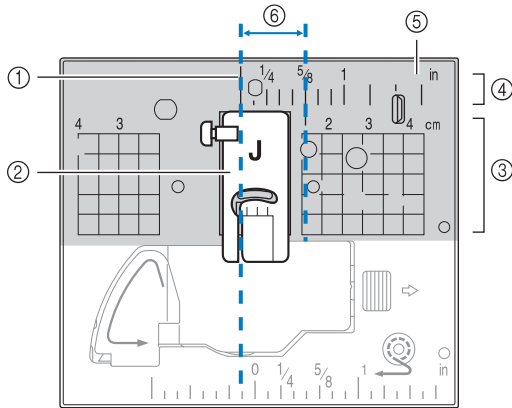

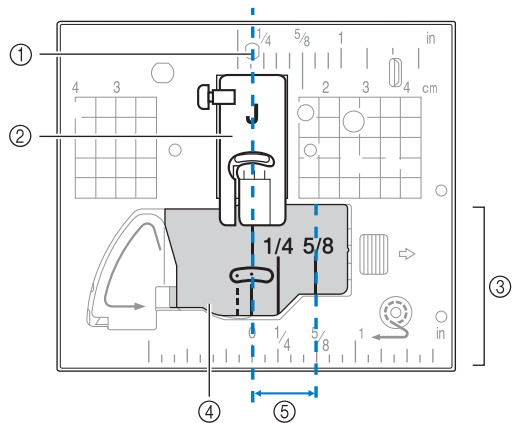

- ① Seam
- ② Presser foot
- ③ Centimeters
- ④ Inches
- ⑤ Needle plate
- ⑥ 5/8 inch (approx. 1.6 cm)

For stitches with a middle (center) needle position (Stitch width: 3.5 mm)



- ① Seam
- ② Presser foot
- ③ Inches
- ④ Bobbin cover (with mark)
- ⑤ 5/8 inch (approx. 1.6 cm)

■ Basting

- 1 Select  and attach presser foot "J".
- 2 Keep pressing  (Reverse stitch button) or  (Reinforcement stitch button) to sew 4 stitches of reinforcement stitches, then press "Start/Stop" button to continue sewing.

Memo

- Before sewing, pull up the bobbin thread, align it with the upper thread, and then pull them to the back of the machine. (page 35) For clean stitching, hold these thread ends when starting to sew.
- You can set the stitch length between 5 mm (approx. 3/16 inch) and 30 mm (approx. 1-3/16 inches).

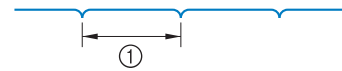

- ① Between 5 mm (approx. 3/16 inch) and 30 mm (approx. 1-3/16 inches)

- 3 When sewing is finished, sew reinforcement stitches, and then cut the threads to a generous length.

■ Dart Seam

- 1 Select  and attach presser foot "J".
- 2 Sew a reverse stitch at the beginning of the dart and then sew from the wide end to the other end without stretching the fabric.

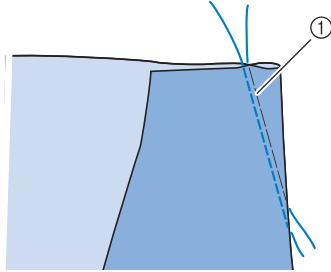

① Basting

- 3 Cut the thread at the end leaving 5 cm (approx. 2 inches), and then tie both ends together.

* Do not sew a reverse stitch at the end.

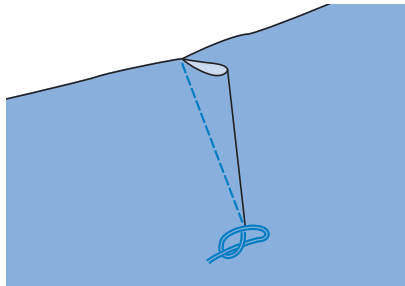

- 4 Insert the ends of the thread into the dart with a hand sewing needle.

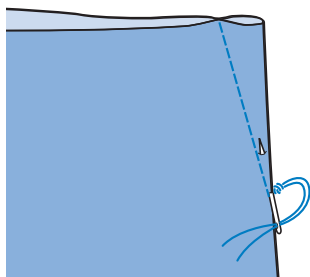

- 5 Iron the dart to one side so that it is flat.

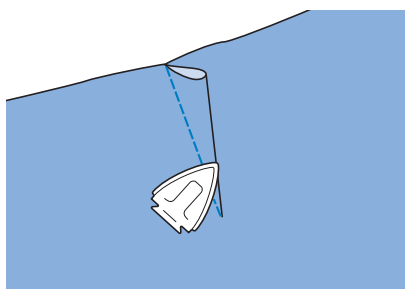

■ Gathering

Use on waists of skirts, sleeves of shirts, etc.

- 1 Select a straight stitch and attach presser foot "J".

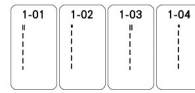

- 2 Set the stitch length to 4.0 mm (approx. 3/16 inch) and the thread tension to approximately 2.0 (weaker tension).
- 3 Pull the bobbin and upper threads out by about 10 cm (approx. 4 inches) (page 35).

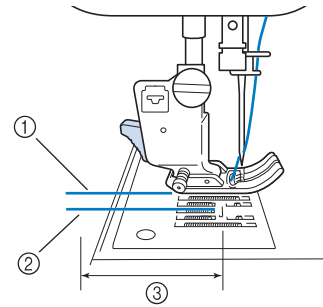

- ① Upper thread
- ② Bobbin thread
- ③ About 10 cm (approx. 4 inches)

- 4 Sew two rows of straight stitches parallel to the seam line, then trim excess thread leaving about 5 cm (approx. 2 inches).

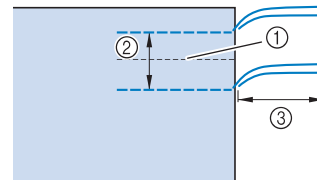

- ① Seam line
- ② 1 cm to 1.5 cm (approx. 3/8 inch to 9/16 inch)
- ③ About 5 cm (approx. 2 inches)

- 5 Pull the bobbin threads to obtain the desired amount of gather, then tie the threads.

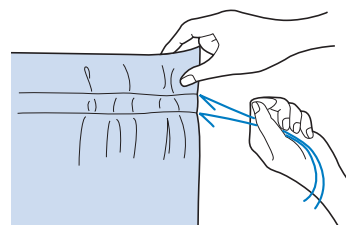

- 6 Smooth the gathers by ironing them.

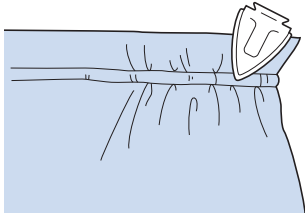

- 7 Sew on the seam line and remove the basting stitch.

■ Flat Fell Seam

Use for reinforcing seams and finishing edges neatly.

- 1 Select  and attach presser foot "J".

- 2 Sew the seam line, then cut half of the seam allowance from the side on which the flat fell seam will lie.

* When the automatic thread cutting and automatic reinforcement stitching are preset, reverse stitches will be sewn automatically at the beginning of sewing. Press  (Reinforcement stitch button) to sew a reinforcement stitch and trim the thread automatically at the end of sewing.

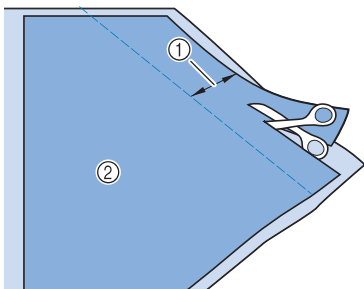

- ① About 1.2 cm (approx. 1/2 inch)
② Wrong side

- 3 Spread the fabric out along the seam.

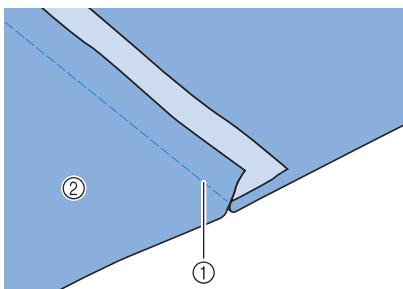

- ① Seam
② Wrong side

- 4 Lay both seam allowances on the side of the shorter seam (cut seam) and iron them.

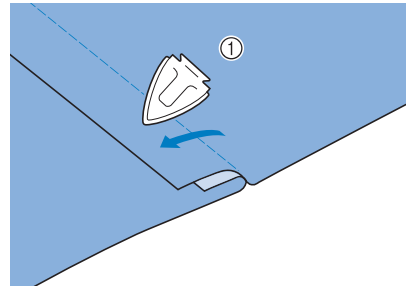

- ① Wrong side

- 5 Fold the longer seam allowance around the shorter one, and sew the edge of the fold.

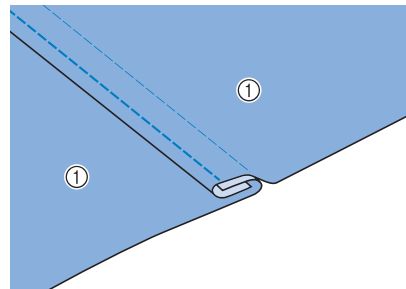

- ① Wrong side
Finished flat fell seam

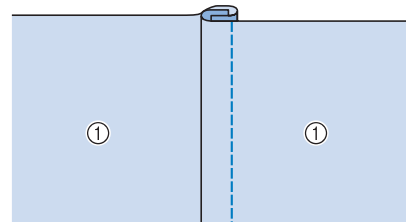

- ① Surface

■ Pintuck

- 1 Mark along the folds on the wrong side of the fabric.

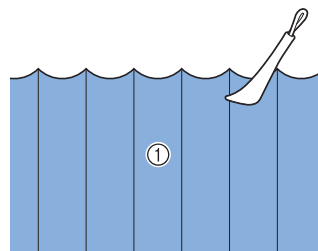

- ① Wrong side

- 2** Turn the fabric and iron the folded parts only.

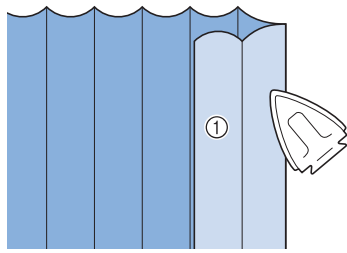

① Surface

- 3** Select  and attach presser foot "J".

- 4** Sew a straight stitch along the fold.

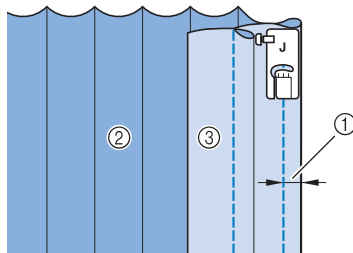

① Width for pintuck
② Wrong side
③ Surface

- 5** Iron the folds in the same direction.

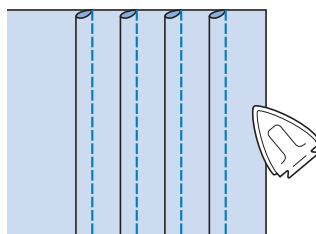

Zigzag Stitches

■ Cord Guide Bobbin Cover (Using a Zigzag Stitch)

- 1** Remove the bobbin cover from the machine (page 34).

- 2** Thread the gimp thread through the hole in the cord guide bobbin cover from bottom to top. Position the thread in the notch at the back of the cord guide bobbin cover.

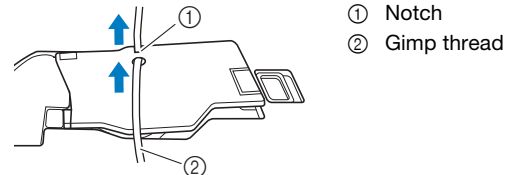

- 3** Snap the cord guide bobbin cover into place, making sure that the gimp thread can be fed freely.

* Make sure there are no restrictions when feeding the thread.

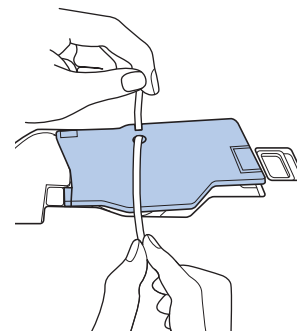

- 4** Set the zigzag width from 2.0-2.5 mm (approx. 1/16 - 3/32 inch).

- 5** Attach advanced monogramming foot "N+".

- 6** Position the fabric right side up on top of the cord and place the cord to the rear of the machine under the presser foot.

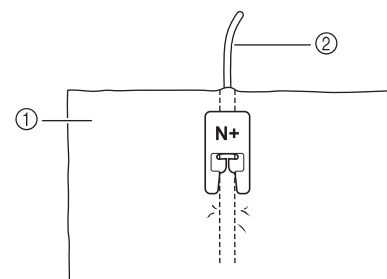

① Fabric (right side)
② Gimp thread

- 7 Lower the presser foot and start sewing to make a decorative finish.

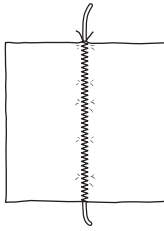

Overcasting

Sew overcasting stitches along the edges of cut fabric to prevent them from fraying.

Memo

- For details on stitch patterns, refer to “STITCH SETTING CHART” on page 197.

■ Using Overcasting Foot “G”

- 1 Select a stitch.

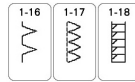

- 2 Attach overcasting foot “G”.



⚠ CAUTION

- When using overcasting foot “G”, be sure select a stitch that can be used with overcasting foot “G”. If you sew with the incorrect stitch, the needle may strike the presser foot and break, and may cause injury.

- 3 Position the fabric with the edge of the fabric against the guide of the presser foot, and then lower the presser foot lever.

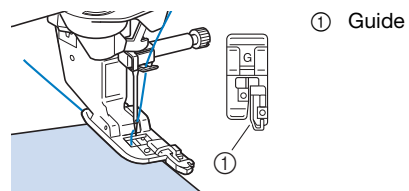

- 4 Rotate the handwheel toward you (counterclockwise). Check that the needle does not touch the presser foot.

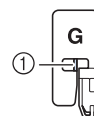

- ① The needle should not touch the center bar

- Sew with the edge of the fabric against the presser foot guide.

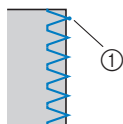

① Needle drop point

IMPORTANT

- Be sure to pull the fabric backward after finished sewing. If you pull the fabric toward side or forward, the presser foot pin may be damaged.
- If thread is tangled on the presser foot, remove the entangled thread, and then raise the presser foot lever to remove the presser foot. If the presser foot is raised while entangled with thread, the presser foot may be damaged.

- Press the “Start/Stop” button to stop sewing when you have reached the end of the stitching, and raise the presser foot and needle to pull the fabric under the presser foot towards the back of the machine.

■ Using Zigzag Foot “J”

- Select a stitch.

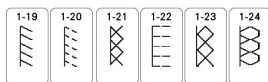

- Attach zigzag foot “J”.

- Sew along the edge of the fabric with the needle dropping off the edge at the right.

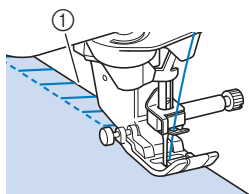

① Needle drop point

Note

- Fine adjustment of the stitching on the fabric can be done with “L/R Shift”. Before sewing your project, be sure to sew trial stitches using the same conditions as in the actual project.

Quilting

You can make beautiful quilts quickly and easily with this machine. When making a quilt, you will find it convenient to use the knee lifter and foot controller to free your hands for other tasks (“Using the Foot Controller” on page 51, “Using Advanced Multi-Function Foot Controller (Included with Some Models)” on page 51 and/or “Using the Knee Lifter” on page 62)

The 40 quilting stitches Q-01 through Q-40, stitches S-02 through S-04 and the utility stitches with “P” or “Q” indicated on their key are useful for quilting.

The “P” or “Q” at the bottom of the key display indicates that these stitches are intended for (“Q”) quilting and (“P”) piecing.

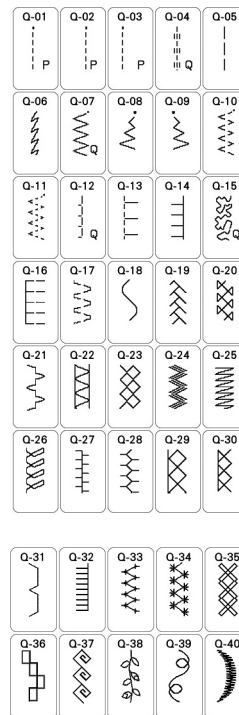

Memo

- When a stitch pattern in the quilting stitches category (only quilting stitches marked with “Q”) is selected, a finer stitch width can be set than that available with stitch patterns in other categories.
- For details on stitch patterns, refer to “STITCH SETTING CHART” on page 197.

■ Piecing

Sewing two pieces of fabric together is called piecing. When cutting pieces for quilt blocks, make sure the seam allowance is 6.5 mm (approx. 1/4 inch).

- Select a stitch and attach presser foot “J”.



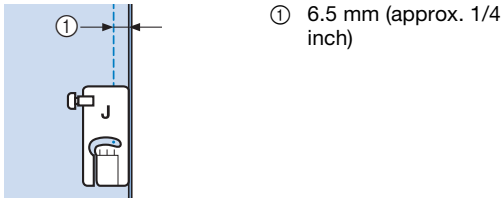

2 Align the edge of the fabric with the edge of the presser foot, and start sewing.

* To sew a 6.5 mm (approx. 1/4 inch) seam allowance along the right edge of the presser foot with  (Q-02) selected, the width (which is the needle position) should be set to 5.50 mm (approx. 7/32 inch).

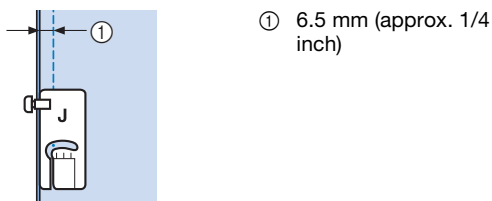

* To sew a 6.5 mm (approx. 1/4 inch) seam allowance along the left edge of the presser foot with  selected, the width should be set to 1.50 mm (approx. 1/16 inch).



* To change the needle position, use  or  in the L/R Shift display.



Memo

- In the case Q-01(center, at L/R Shift 3.5 mm) is selected, if the guideline marker is set at 10.0 mm (3.5 mm plus 6.5 mm, close to 1/4 inch), you can sew piecing by referring to the guideline marker.

■ Piecing Using the 1/4 Piecing Foot with Guide

This piecing foot can sew an accurate 1/4 inch or 1/8 inch seam allowance. It can be used for piecing together a quilt or for topstitching.

1 Select  and then attach the 1/4 piecing foot with guide.

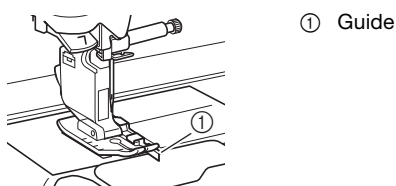

2 Use the guide and marks on the presser foot to sew accurate seam allowances.

Piecing a 1/4 inch seam allowance

Sew keeping the edge of the fabrics against the guide.

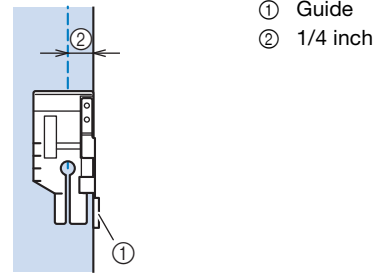

Memo

- For accurate fabric placement, refer to “Aligning the Fabric with a Mark on the Needle Plate or Bobbin Cover (with Mark)” on page 68.

Creating an accurate seam allowance

Use the mark on the foot to begin, end, or pivot 1/4 inch from edge of fabric.

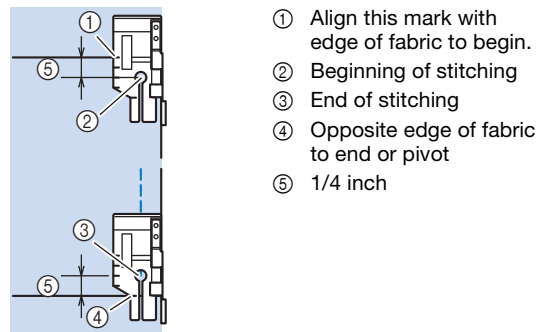

Memo

- For details on pivoting, refer to “Pivoting” on page 61.

Topstitching quilting, 1/8 inch

Sew with the edge of the fabric aligned with the left side of the presser foot's front section.

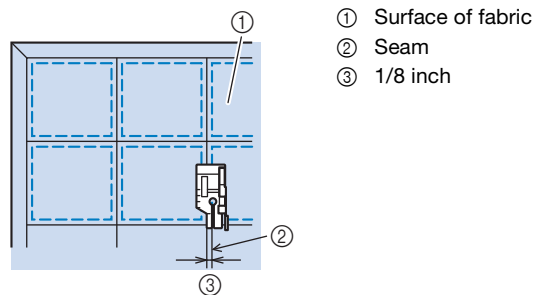

■ Quilting

Sewing the quilt top, batting, and backing together is called quilting. You can sew the quilt with the compact dual feed foot to keep the quilt top, batting, and backing from sliding. The compact dual feed foot has a motorized belt that moves together with the feed dogs in the needle plate during sewing.

For straight line quilting, use the compact dual feed foot and the straight stitch needle plate. Always select a straight stitch (middle needle position) when using the straight stitch needle plate.

1 Select a stitch.

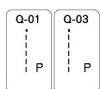

2 Attach the compact dual feed foot (page 46).

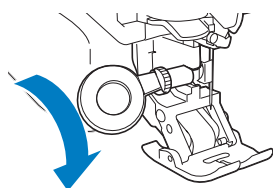

3 Place one hand on each side of the presser foot to hold the fabric secure while sewing.

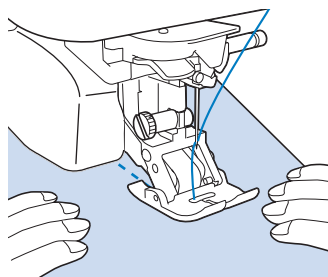

Memo

- Sew at slow to medium speed.
- Always check to be sure that your quilting project is securely basted before beginning to sew.

■ Appliqué

1 Use two-sided stabilizer material to secure the appliqué piece to the base fabric.

2 Select .

3 Attach the zigzag foot “J”.

4 Turn the handwheel toward you (counterclockwise), and then begin sewing around the edge of the appliqué, making sure that the needle drops just outside of the appliqué.

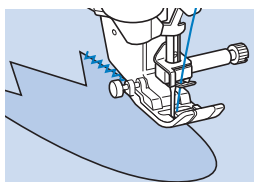

When sewing around corners, stop the machine with the needle in the fabric just outside of the appliqué, raise the presser foot lever, and then turn the fabric as needed to change the sewing direction.

■ Quilting with Satin Stitches

For better fabric control, use the foot controller to sew with satin stitches. Set the speed control slide to control the stitch width to make subtle changes in the stitch width during sewing.

1 Attach the foot controller (page 51).

2 Select and attach presser foot “J”.

3 Touch in the length display to shorten the stitch length.



Memo

- The setting will vary according to the kind of fabric and the thickness of the thread, but a length of 0.3 to 0.5 mm (approx. 1/64 to 1/32 inch) is best for satin stitches.

4 Touch to use the speed control slide to control the stitch width.

5 Set the [Width Control] to [ON].



6 Touch .

→ The display will return to the original screen.

7 While sewing, slide the sewing speed controller to adjust the stitch width.

* Adjust the sewing speed with the foot controller.

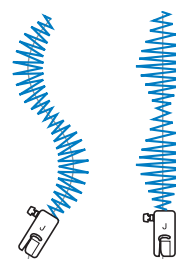
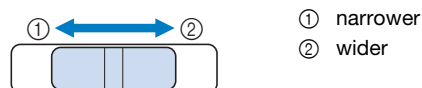

8 When you are finished sewing, set the [Width Control] back to [OFF].

Free Motion Quilting



With free motion quilting, the feed dogs can be lowered by touching , so that the fabric can be moved freely in any direction.

For free motion quilting, use free motion quilting foot “C” or free motion open toe quilting foot “O” depending on the stitch that is selected, and set the machine to free motion sewing mode. In this mode, the presser foot is raised to the necessary height for free motion sewing. We recommend attaching the foot controller and sewing at a consistent speed. You can adjust the sewing speed with the speed control slide on the machine.

CAUTION

- With free motion quilting, control the feeding speed of the fabric to match the sewing speed. If the fabric is moved faster than the sewing speed, the needle may break and cause injury.

Memo

- When starting to sew, the internal sensor detects the thickness of the fabric, and the quilting foot is raised to the height specified in the machine settings screen. Touch  to display [Free Motion Foot Height] of the settings screen. Touch  or  to select the height that the quilting foot is raised above the fabric.



- In order to sew with a balanced tension, it may be necessary to adjust the upper thread tension. Test with a sample piece of fabric that is similar to your chosen fabric.
- Do not be discouraged with your initial results. The technique requires practice.

Using free motion quilting foot “C” (Included with some models)

Use the free motion quilting foot “C” with straight stitch needle plate for free motion sewing.

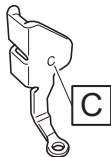

Free motion quilting foot “C”

CAUTION

- When using free motion quilting foot “C”, be sure to use the straight stitch needle plate. If the needle is moved to any position other than the middle (center) needle position, the needle may break, which may result in injuries.

1 Attach the straight stitch needle plate (page 63).

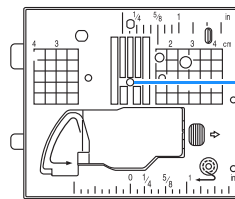

① Round hole

CAUTION

- The machine must be turned off and unplugged when switching the needle plate.

2 Select a stitch.

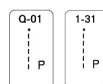

3 Touch to set the machine to free motion sewing mode.

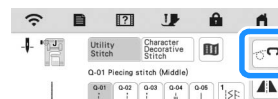

→ The key appears as , the quilting foot is raised to the necessary height, and then the feed dogs are lowered for free motion sewing.

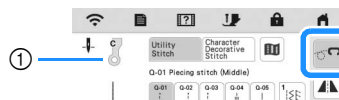

① Free motion quilting foot “C”

→ When stitch Q-01 or 1-31 is selected, free motion quilting foot “C” is indicated in the upper-left corner of the screen.

4 Remove the presser foot holder (page 45).

5 Attach free motion quilting foot “C” at the front with the presser foot holder screw aligned with the notch in the foot.

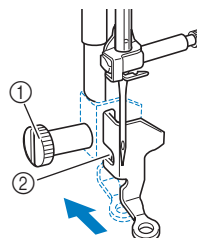

① Presser foot holder screw

② Notch

Note

- Make sure that the free motion quilting foot “C” is attached properly and not slanted.

- 6 Hold the free motion quilting foot “C” in place with your right hand, and tighten the presser foot holder screw using the disc-shaped screwdriver with your left hand.

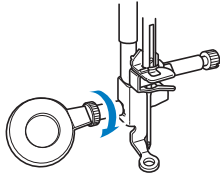

⚠ CAUTION

- Be sure to securely tighten the screws with the disc-shaped screwdriver. Otherwise, the needle may touch the free motion quilting foot “C”, causing it to break and causing injury.

- 7 Use both hands to stretch the fabric taut, and then move the fabric at a consistent pace in order to sew uniform stitches roughly 2.0-2.5 mm (approx. 1/16 - 3/32 inch) in length.

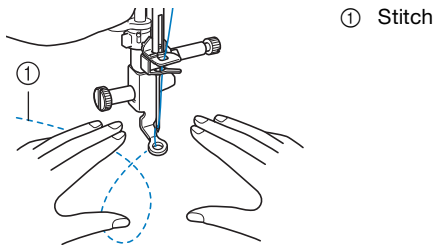

- 8 Touch  to cancel the free motion sewing mode.

→ Rotate the handwheel toward you (counterclockwise) to raise the feed dogs.

- 9 After sewing, make sure to remove the straight stitch needle plate and free motion quilting foot “C”, and reinstall the regular needle plate.

💡 Note

- Free motion open toe quilting foot “O” can also be used with the straight stitch needle plate. We recommend using free motion open toe quilting foot “O” with free motion sewing of fabrics of uneven thicknesses.

- Using free motion open toe quilting foot “O”

The free motion open toe quilting foot “O” is used for free motion quilting with zigzag or decorative stitches or for free motion quilting of straight lines on fabric with an uneven thickness. Various stitches can be sewn using free motion open toe quilting foot “O”. For details on the stitches that can be used, refer to “STITCH SETTING CHART” on page 197.

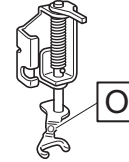

Free motion open toe quilting foot “O”

📖 Memo

- The standard needle plate must be used if zigzag or decorative stitch patterns are selected.

- 1 Touch  to set the machine to free motion sewing mode.

→ The key appears as , the quilting foot is raised to the necessary height, and then the feed dogs are lowered for free motion sewing.

- 2 Select a stitch.

📖 Memo

- When stitch Q-01 or 1-31 is selected, free motion quilting foot “C” is indicated in the upper-left corner of the screen. When the other stitches are selected, free motion open toe quilting foot “O” is indicated in the screen.

- 3 Remove the presser foot holder (page 45).

- 4 Attach free motion open toe quilting foot “O” by positioning the pin of the foot above the needle clamp screw and aligning the lower-left of the foot and the presser bar.

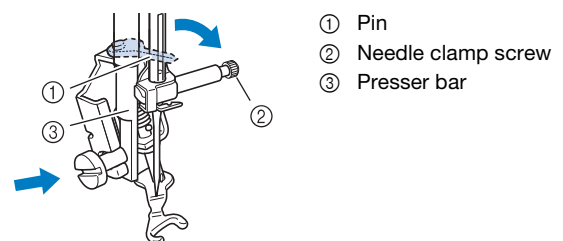

💡 Note

- Make sure that the free motion open toe quilting foot “O” is not slanted.

- 5 Hold the free motion open toe quilting foot "O" in place with your right hand, and tighten the presser foot holder screw using the disc-shaped screwdriver with your left hand.

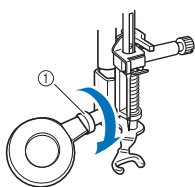

① Presser foot holder screw

⚠ CAUTION

- Be sure to securely tighten the screws with the disc-shaped screwdriver. Otherwise, the needle may touch the free motion open toe quilting foot "O", causing it to break and causing injury.

- 6 Use both hands to stretch the fabric taut, and then move the fabric at a consistent pace in order to sew uniform stitches roughly 2.0-2.5 mm (approx. 1/16 - 3/32 inch) in length.

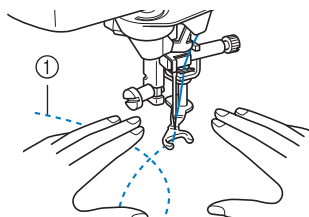

① Stitch

- 7 Touch to cancel the free motion sewing mode.
→ Rotate the handwheel toward you (counterclockwise) to raise the feed dogs.

■ Echo Quilting Using the Free Motion Echo Quilting Foot "E" (Included with Some Models)

Sewing quilting lines at equal distances around a motif is called echo quilting. The quilting lines, which appear as ripples echoing away from the motif, are the distinguishing characteristic of this quilting style. Use the free motion echo quilting foot "E" for echo quilting. Using the measurement on the presser foot as a guide, sew around the motif at a fixed interval. We recommend attaching the foot controller and sewing at a consistent speed.

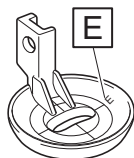

Free motion echo quilting foot "E" measurements

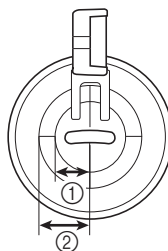

- ① 6.4 mm (approx. 1/4 inch)
- ② 9.5 mm (approx. 3/8 inch)

- 1 Select .
- 2 Touch to set the machine to free motion sewing mode.
→ The key appears as , the quilting foot is raised to the necessary height, then the feed dogs are lowered for free motion sewing.
- 3 Remove the presser foot holder and then attach the adapter. (page 45)
- 4 Position the free motion echo quilting foot "E" on the left side of the presser bar with the holes in the foot and presser bar aligned.

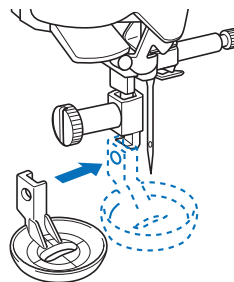

- 5 Tighten the screw with the included screwdriver (large).

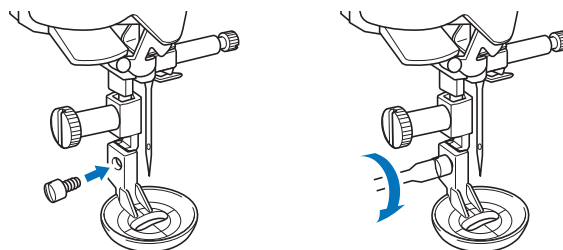

⚠ CAUTION

- Be sure to securely tighten the screws with the included screwdriver (large). Otherwise, the needle may touch the free motion echo quilting foot "E", causing it to break and causing injury.

- 6** Using the measurement on the free motion echo quilting foot “E” as a guide, sew echo quilting around the motif.

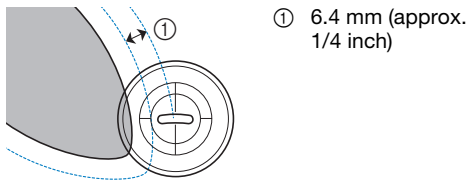
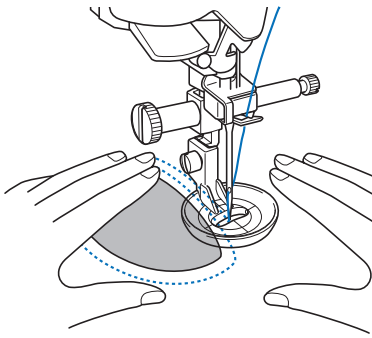

Finished project

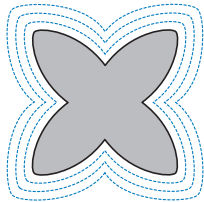

- 7** Touch  to cancel the free motion sewing mode.
→ Rotate the handwheel toward you (counterclockwise) to raise the feed dogs.

Blind Hem Stitches

Secure the lower edge of skirts and pants with a blind hem.

Memo

- When the size of cylindrical pieces is too small to slide onto the arm or the length is too short, the fabric will not feed and desired results may not be achieved.
- For details on stitch patterns, refer to “STITCH SETTING CHART” on page 197.

- 1** Turn the skirt or pants inside out.

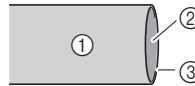

- ① Wrong side of fabric
- ② Right side of fabric
- ③ Lower edge of fabric

- 2** Fold the lower edge of fabric to the desired length to be hemmed and then press.

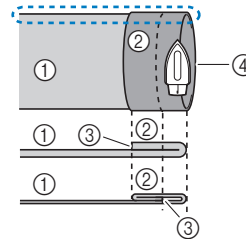

- ① Wrong side of fabric
- ② Right side of fabric
- ③ Lower edge of fabric
- ④ Desired length for hem

<Thick fabric>

<Normal fabric>

<Seen  from the side>

- 3** Using tailor's chalk, mark the fabric about 5 mm (approx. 3/16 inch) from the edge of the fabric, and then baste it.

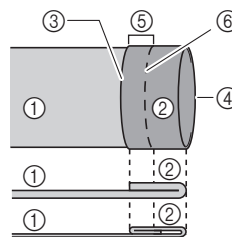

- ① Wrong side of fabric
- ② Right side of fabric
- ③ Lower edge of fabric
- ④ Desired length for hem
- ⑤ 5 mm (approx. 3/16 inch)
- ⑥ Basting

<Thick fabric>

<Normal fabric>

<Seen from the side>

- 4** Fold back the fabric inside along the basting.

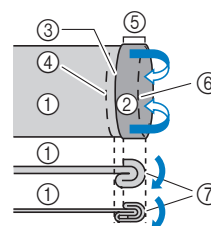

- ① Wrong side of fabric
- ② Right side of fabric
- ③ Lower edge of fabric
- ④ Desired length for hem
- ⑤ 5 mm (approx. 3/16 inch)
- ⑥ Basting
- ⑦ Basting point

<Thick fabric>

<Normal fabric>

<Seen from the side>

5 Unfold the edge of fabric, and position the fabric with the wrong side facing up.

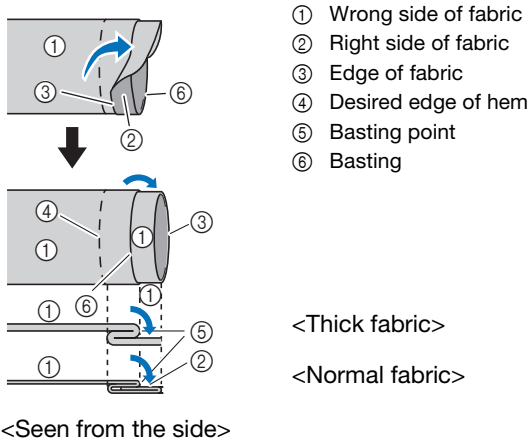

6 Select a stitch.



7 Attach blind stitch foot "R".



8 Remove the flat bed attachment to use the free arm.

9 Slide the item that you wish to sew onto the free arm, make sure that the fabric feeds correctly.

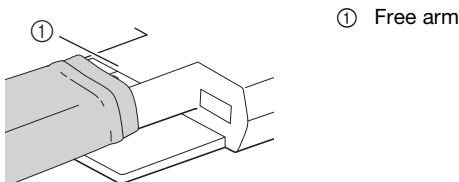

10 Position the fabric with the edge of the folded hem against the guide of the presser foot, and then lower the presser foot lever.

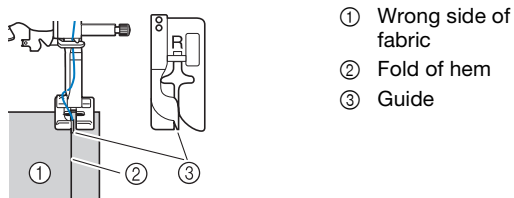

11 Adjust the stitch width until the needle slightly catches the fold of the hem. (page 57)



When you change the needle drop point, raise the needle, and then use ∇ and \wedge to decide the needle drop point. (The stitch width setting is in neither millimeters nor inches.)

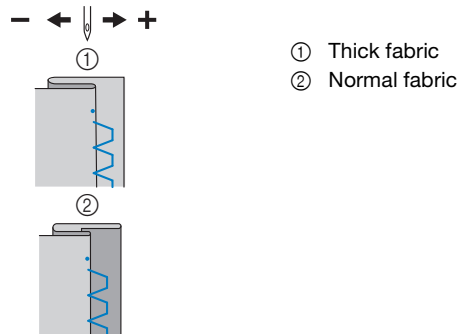

Memo

- Blind hem stitches cannot be sewn if the left needle drop point does not catch the fold. If the needle catches too much of the fold, the fabric cannot be unfolded and the seam appearing on the right side of the fabric will be very large, leaving an unattractive finish.

12 Sew with the fold of the hem against the presser foot guide.

13 Press the "Start/Stop" button to stop sewing when you are finished, and raise the presser foot and needle to pull the fabric under the presser foot towards the left of the machine.

IMPORTANT

- Be sure to pull the fabric towards the back of the machine after sewing. If you pull the fabric toward side or forward, the presser foot may be damaged.

14 Remove the basting stitching and turn the fabric with the right side facing out.

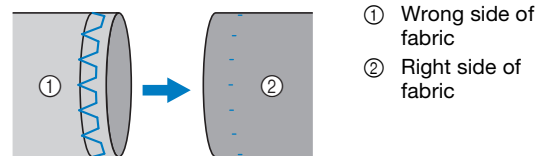

Shell Tuck Stitches

The gathers that look like shells are called "shell tucks". They are used to decorate trims, the front of blouses or cuffs made of thin fabrics.

Memo

- For details on stitch patterns, refer to "STITCH SETTING CHART" on page 197.

- 1 Draw equally spaced lines along the bias, and then fold the fabric along the lines.

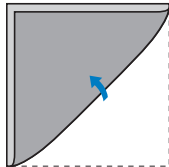

- 2 Select , and then increase the thread tension.

- 3 Attach zigzag foot "J".

- 4 Sew while making sure that the needle drops slightly off the edge of the fabric.

One fold at a time, continue folding the fabric along the line, then sewing it.

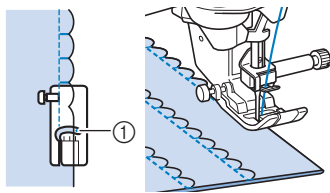

① Needle drop point

- 5 After sewing is finished, remove the fabric. Unfold the fabric, and then iron the tucks down to one side.

Scallop Stitches

The wave-shaped satin stitch is called "scalloping". Use this stitch to decorate the edges of blouse collars and handkerchiefs or use it as a hem accent.

Memo

- For details on stitch patterns, refer to "STITCH SETTING CHART" on page 197.

- 1 Select .

- 2 Attach advanced monogramming foot "N+".

- 3 Stitch along the edge of the fabric, making sure not to sew directly on the edge of the fabric.

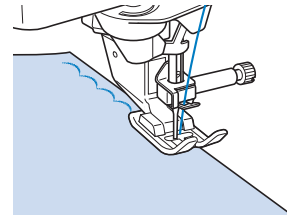

- 4 Trim along the stitches.

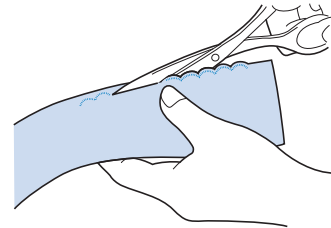

- Be careful not to cut the stitches.

Smocking Stitches

The decorative stitch created by stitching or embroidering over gathers is called "smocking". It is used to decorate the front of blouses or cuffs.

The smocking stitch adds texture and elasticity to fabric.

Memo

- For details on stitch patterns, refer to "STITCH SETTING CHART" on page 197.

- 1 Select the straight stitch, and then adjust the stitch length to 4.0 mm (approx. 3/16 inch) and loosen the thread tension.

- 2 Attach zigzag foot "J".

- 3 Sew parallel stitching at intervals of 1 cm (approx. 3/8 inch) and pull the bobbin threads to create gathers.

Smooth the gathers by ironing them.

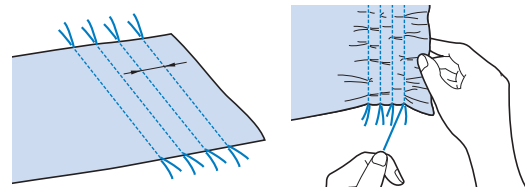

- 4 Select a stitch.

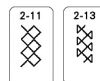

- 5 **Stitch between the straight stitches and pull out the threads for the straight stitches.**

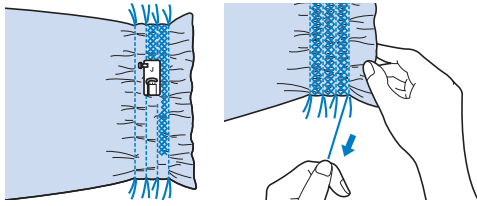

Fagoting

Stitching across an open seam is called “fagoting”. It is used on blouses and children’s clothing. This stitch is more decorative when thicker thread is used.

Memo

- For details on stitch patterns, refer to “STITCH SETTING CHART” on page 197.

- 1 **Use an iron to fold the two pieces of fabric along their seams.**
- 2 **Baste the two pieces of fabric, separated by about 4 mm (approx. 3/16 inch), onto thin paper or a sheet of water soluble stabilizer.**
If you draw a line down the middle of the thin paper or water soluble stabilizer, sewing is easier.

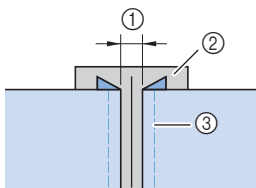

- ① About 4 mm (approx. 3/16 inch)
- ② Thin paper or water soluble stabilizer
- ③ Basting stitching

- 3 **Select a stitch.**



- 4 **Attach zigzag foot “J”.**
- 5 **Set the stitch width to 7.0 mm (approx. 1/4 inch).**
- 6 **Sew with the center of the presser foot aligned along the center of the two pieces of fabric.**

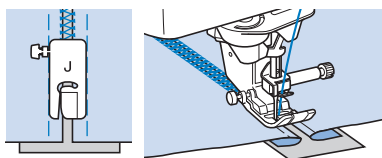



- 7 **After sewing is finished, remove the paper.**

Attaching Tape or Elastic

Memo

- For details on stitch patterns, refer to “STITCH SETTING CHART” on page 197.

- 1 **Select a straight stitch and attach presser foot “J”.**
 - 2 **Set the stitch length to 4.0 mm (approx. 3/16 inch), and loosen the upper thread tension to 2.0 (page 58).**
- ### Memo
- Be sure that neither automatic reinforcement  nor automatic thread cutting  is selected.
- 3 **Sew two rows of straight stitches on the right side of the fabric, then pull the bobbin thread to create the necessary gather.**

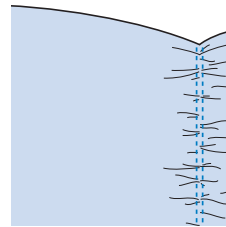

Memo

- Before sewing the straight stitch, rotate the handwheel toward you (counterclockwise) and pull up the bobbin thread. Holding the top and bobbin thread, pull a length of thread out from the rear of the machine. (Be sure that the presser foot is raised.)

- 4 **Place the tape over the gather, and hold it in place with basting pins.**

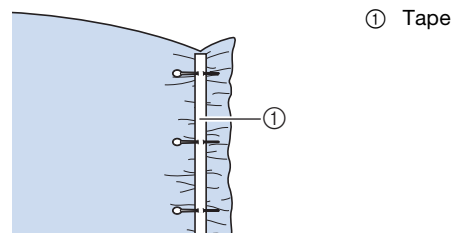

- 5 **Select a stitch.**

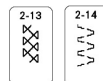

6 Sew over the tape (or elastic).

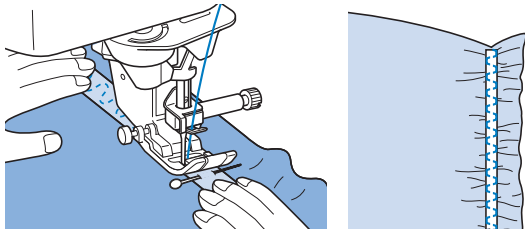

⚠ CAUTION

- Be sure the needle does not strike a basting pin, or any other objects, during sewing. The thread could tangle or the needle could break, causing injury.

7 Pull out the straight stitch threads.

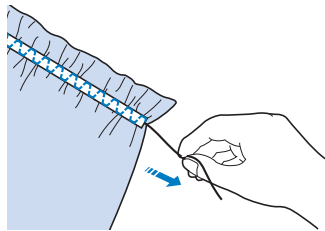

One-Step Buttonholes

With one-step buttonholes, you can make buttonholes appropriate to the size of your button.

One-step buttonholes are sewn from the front of the presser foot to the back, as shown below.

Memo

- For details on stitch patterns, refer to “STITCH SETTING CHART” on page 197.

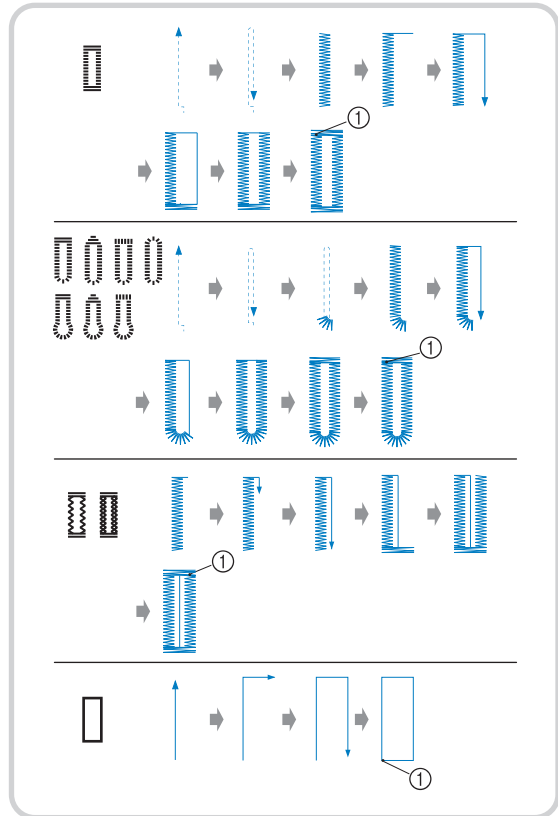

① Reinforcement stitching

1 Select a buttonhole stitch, and attach buttonhole foot “A”.

Position the upper thread under the presser foot by guiding thread through the hole in the presser foot before attaching the buttonhole foot “A”.

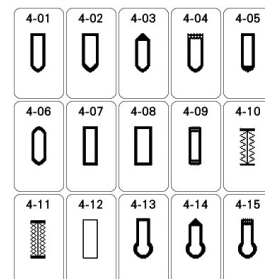

2 Mark the position and length of the buttonhole on the fabric.

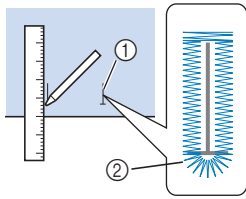

- ① Marks on fabric
- ② Buttonhole sewing

Memo

- The maximum buttonhole length is about 28 mm (approx. 1-1/16 inches) (diameter + thickness of the button).

3 Pull out the button holder plate on the presser foot, and insert the button that will be put through the buttonhole. Then tighten the button holder plate around the button.

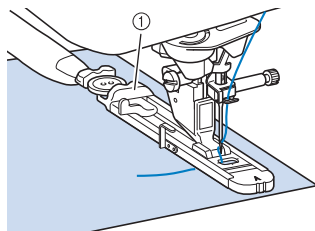

- ① Button holder plate

Memo

- The size of the buttonhole is determined by the size of the button in the button holder plate.

4 Align the presser foot with the mark on the fabric, and lower the presser foot.

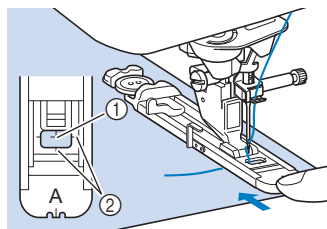

- ① Mark on the fabric
- ② Marks on the presser foot

Note

- Slide the outside frame of the buttonhole foot backward as far as possible as shown in the illustration, making sure that there is no gap behind the part of the foot marked "A". If the buttonhole foot is not slid back as far as possible, the buttonhole will not be sewn at the correct size.

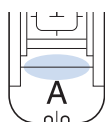

5 Lower the buttonhole lever so that it is positioned behind the metal bracket on the buttonhole foot.

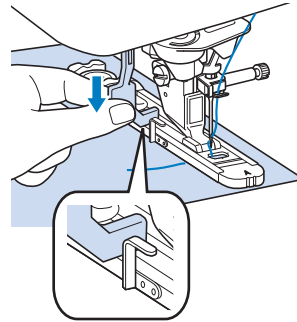

6 Gently hold the end of the upper thread, and then start sewing.

- * Feed the fabric carefully by hand while the buttonhole is sewn.

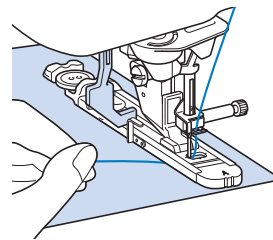

→ Once sewing is completed, the machine automatically sews reinforcement stitches, and then stops.

7 Press the "Thread Cutter" button once. Raise the presser foot, and then remove the fabric.

Memo

- When using the thread cutter on the left side of the machine or scissors to cut the threads, press the "Needle Position" button to raise the needle, raise the presser foot, and then pull out the fabric before cutting the threads.

8 Insert a pin along the inside of one of the bar tacks, and then insert the seam ripper into the center of the buttonhole and cut towards the pin.

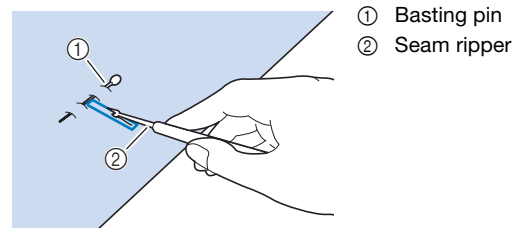

- ① Basting pin
- ② Seam ripper

CAUTION

- When using the seam ripper to open the buttonhole, do not put your hand or finger in the path of the ripper. The ripper may slip and cause injury.

Memo

- For keyhole buttonholes, use the eyelet punch to make a hole in the rounded end of the buttonhole. Then insert a pin along the inside of one of the bar tacks, insert a seam ripper into the hole made with the eyelet punch, and cut towards the pin.

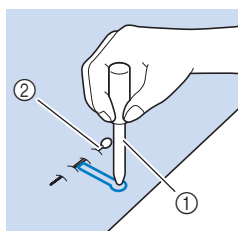



- ① Eyelet punch
- ② Basting pin

Sewing Stretch Fabrics

Note

- Attach stabilizer material to the back of stretch fabrics to prevent them from stretching.

When sewing on stretch fabric with  or , sew the buttonhole stitches over a gimp thread.

- Hook the gimp thread onto the back of presser foot "A". Insert the ends into the grooves at the front of the presser foot, and then temporarily tie them there.

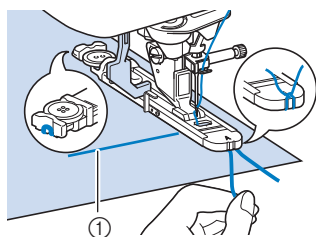

- ① Upper thread

- Lower the presser foot and start sewing.

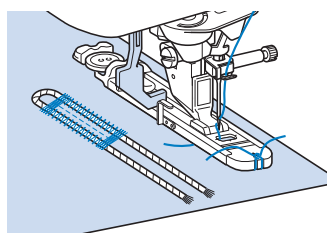

- Once sewing is completed, gently pull the gimp thread to remove any slack, and trim off any excess.

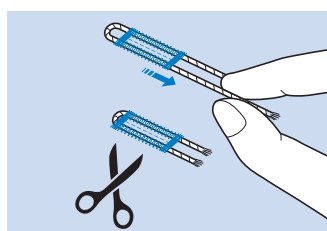

Odd Shaped Buttons/Buttons that Do Not Fit into the Button Holder Plate

Add together the diameter and thickness of the button, and then set the button holder plate to the calculated length. (The distance between the markings on the presser foot scale is 5 mm (approx. 3/16 inch).)

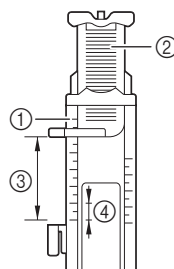

- ① Presser foot scale
- ② Button holder plate
- ③ Combined measurement of diameter + thickness
- ④ 5 mm (approx. 3/16 inch)

Example: For a button with a diameter of 15 mm (approx. 9/16 inch) and a thickness of 10 mm (approx. 3/8 inch), the scale should be set at 25 mm (approx. 1 inch).

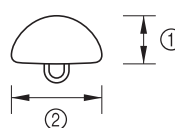

- ① 10 mm (approx. 3/8 inch)
- ② 15 mm (approx. 9/16 inch)

Four-Step Buttonholes

You can sew 4-step buttonholes using the following 4 stitches together. You can sew any desired length for the buttonhole when using 4-step buttonholes. 4-step buttonholes are a good option when attaching oversize buttons.

Memo

- For details on stitch patterns, refer to "STITCH SETTING CHART" on page 197.

Note

- When changing the stitch settings, make sure that all stitch settings are changed to match.

Four-step buttonholes are sewn as shown below.

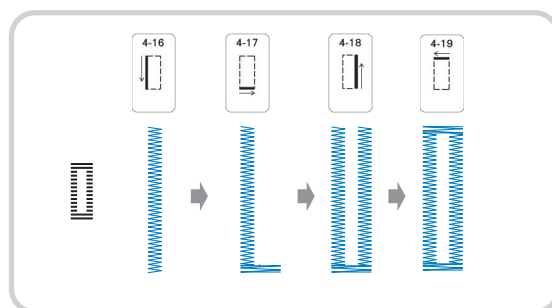

- 1** Mark the position and length of the buttonhole on the fabric.

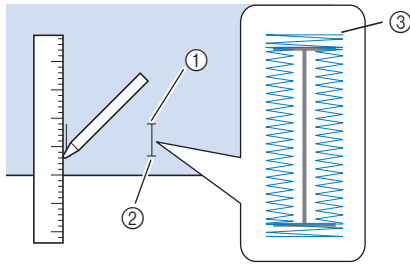

- ① Starting point
- ② End point
- ③ Buttonhole sewing

- 2** Attach advanced monogramming foot “N+”, and select

stitch  to sew the left side of the buttonhole.

- 3** Press the “Start/Stop” button to start sewing.

- 4** Sew the desired length for the buttonhole and press the “Start/Stop” button again.

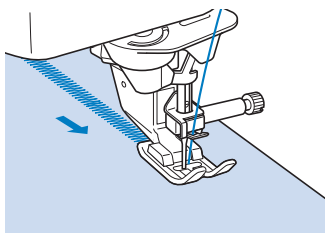

- 5** Select stitch  to sew the bar tack and press the “Start/Stop” button.

→ The machine will automatically stop after sewing the bar tack.

- 6** Select stitch  to sew the right side of the buttonhole, and press the “Start/Stop” button to begin sewing.

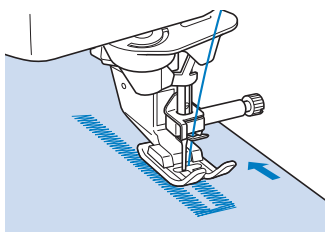

- 7** Sew the right side of the buttonhole and press the “Start/Stop” button again.

* Sew the right side of the buttonhole the same length as the left.

- 8** Select stitch  to sew the bar tack and then press the “Start/Stop” button.

→ The machine will automatically sew off the bar tack tie and stop when the bar tack is complete.

- 9** Raise the presser foot and remove the fabric.



- 10** Open the buttonhole (page 84).

Darning

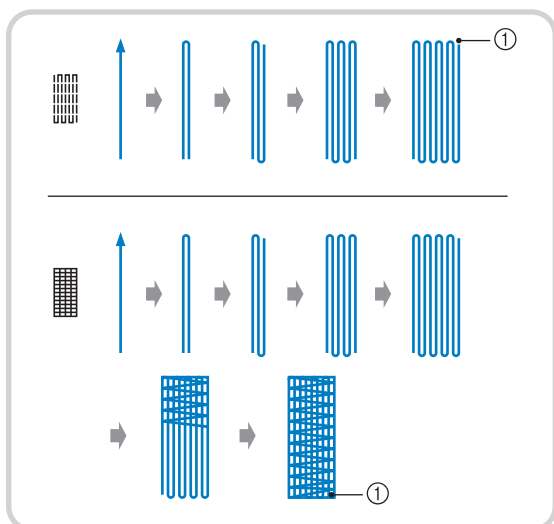
Use darning stitches for mending and other applications. Darning is performed by sewing from the front of the presser foot to the back as shown below.



① Reinforcement stitches

- 1 Select  or , and attach buttonhole foot "A".

Position the upper thread under the presser foot by guiding thread through the hole in the presser foot before attaching the buttonhole foot "A".

- 2 Set the scale to the desired length of the darning.

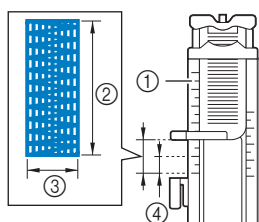

- ① Presser foot scale
- ② Completed length measurement
- ③ Width 7 mm (approx. 1/4 inch)
- ④ 5 mm (approx. 3/16 inch)

- 3 Check that the needle drops at the desired position and lower the presser foot, making sure the upper thread passes underneath the buttonhole foot.

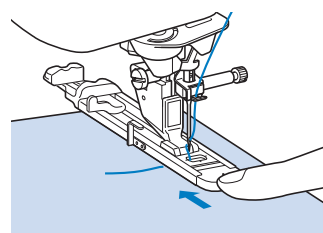

Note

- Slide the outside frame of the buttonhole foot backward as far as possible as shown in the illustration, making sure that there is no gap behind the part of the foot marked "A". If the buttonhole foot is not slid back as far as possible, the buttonhole will not be sewn at the correct size.

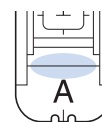

- 4 Lower the buttonhole lever so that it is positioned behind the metal bracket on the buttonhole foot.

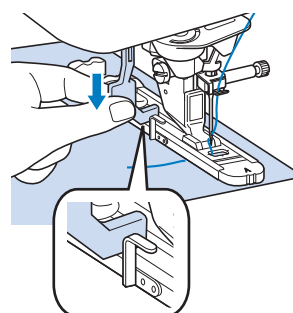

- 5 Gently hold the end of the upper thread, and then press the "Start/Stop" button to start the machine.

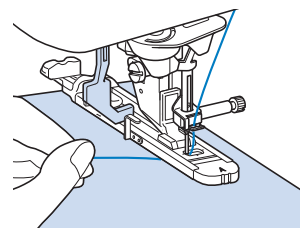

→ Once sewing is completed, the machine automatically sews reinforcement stitches, and then stops.

Bar Tacks

Use bar tacks to reinforce areas that will be subject to strain, such as pocket corners.

Memo

- For details on stitch patterns, refer to "STITCH SETTING CHART" on page 197.

1 Select .

2 Attach buttonhole foot "A" and set the scale to the length of the bar tack you wish to sew.

Position the upper thread under the presser foot by guiding thread through the hole in the presser foot before attaching the buttonhole foot "A".

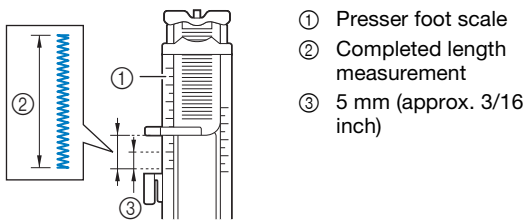

3 Set the fabric so that the pocket moves toward you during sewing.

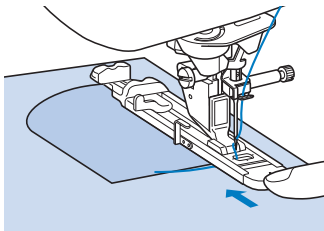

Note

- Slide the outside frame of the buttonhole foot backward as far as possible as shown in the illustration, making sure that there is no gap behind the part of the foot marked "A". If the buttonhole foot is not slid back as far as possible, the buttonhole will not be sewn at the correct size.

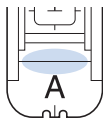

4 Check the first needle drop point and lower the presser foot.

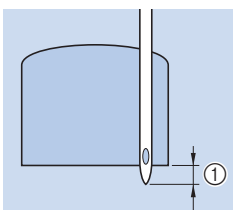

① 2 mm (approx. 1/16 inch)

5 Lower the buttonhole lever so that it is positioned behind the metal bracket on the buttonhole foot.

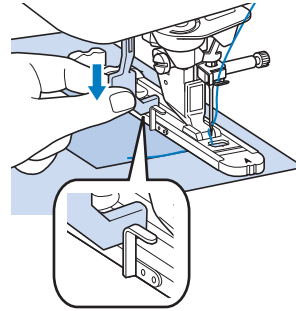

6 Gently hold the end of the upper thread and start sewing.

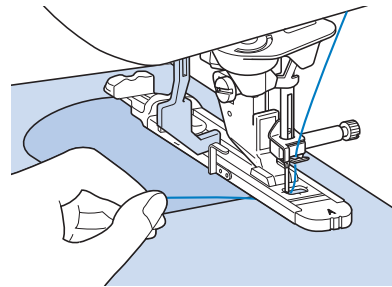

→ When sewing is completed, the machine will sew reinforcement stitches and stop automatically.

Bar Tacks On Thick Fabrics

Place a piece of folded fabric or cardboard beside the fabric being sewn to level the buttonhole foot and allow for easier and even feeding.

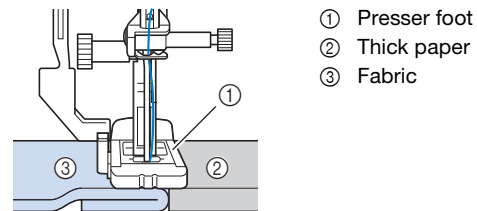

Button Sewing

Buttons with 2 or 4 holes can be attached, using the machine.

Memo

- For details on stitch patterns, refer to "STITCH SETTING CHART" on page 197.

Note

- Do not use the automatic thread cutting function when sewing buttons. Otherwise, you will lose the thread ends.

- 1 Select .
→ The feed dogs are lowered automatically.
- 2 Raise the presser foot.
- 3 Attach button fitting foot "M", slide the button along the metal plate and into the presser foot, and lower the presser foot.

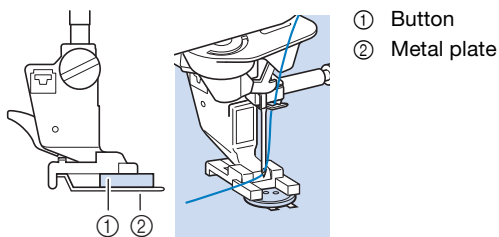

- 4 Rotate the handwheel toward you (counterclockwise) to check that the needle goes into each hole correctly.



- * If the needle does not reach the holes on the left side, adjust the stitch width.

- 5 Gently hold the end of the upper thread and start sewing.
→ The machine stops automatically when sewing is finished.

IMPORTANT

- Make sure the needle does not strike the button during sewing.

- * To attach the button more securely, repeat the process.

- 6 From the wrong side of the fabric, pull the end of the bobbin thread to pull the upper thread through to the wrong side of the fabric. Tie the two thread ends together and cut the threads.

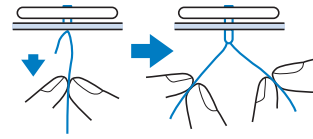

- 7 After the button is attached, select another stitch and rotate the handwheel toward you (counterclockwise) to raise the feed dogs.

■ Attaching 4-Hole Buttons

Sew the two holes closest to you. Then raise the presser foot and move the fabric so that the needle goes into the next two holes, and sew them in the same way.

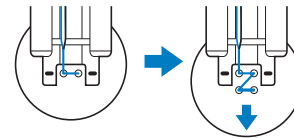

■ Attaching a Shank to the Button

- 1 Pull the shank lever toward you before sewing.

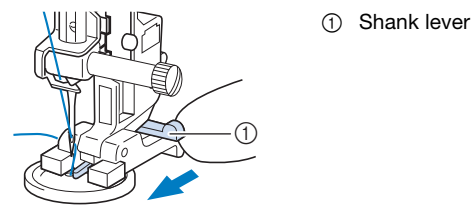

- 2 After sewing is finished, pull the two ends of the upper thread between the button and the fabric, wind them around the shank, and then tie them firmly together.

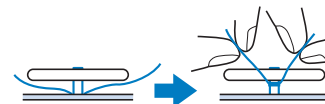

- 3 Tie the ends of the bobbin thread from the beginning and end of sewing together on the wrong side of the fabric.
- 4 Cut off any excess thread.

Eyelet

Use this stitch for making belt holes and other similar applications.

Memo

- For details on stitch patterns, refer to “STITCH SETTING CHART” on page 197.

1 Select a stitch.

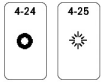

2 Use in either the stitch width display or the stitch length display to choose the size of the eyelet (page 57).

3 Attach advanced monogramming foot “N+”, then rotate the handwheel toward you (counterclockwise) to check the needle drop point.

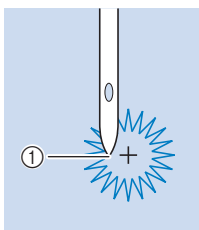

① Needle drop point

4 Lower the presser foot and start sewing.

→ When sewing is finished, the machine sews reinforcement stitches and stops automatically.

5 Use the eyelet punch to make a hole in the center of the stitching.

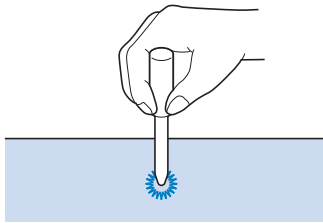

Multi-directional Sewing (Straight Stitch and Zigzag Stitch)

Use these stitch patterns to attach patches or emblems to pant legs, shirt sleeves, etc.

Memo

- For details on stitch patterns, refer to “STITCH SETTING CHART” on page 197.

1 Remove the flat bed attachment to use the free-arm.

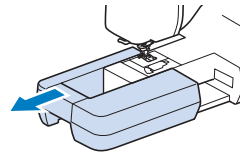

Memo

- Insert the tubular piece of fabric onto the free-arm, and then sew in the order shown in the illustration.

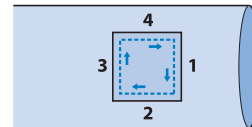

2 Select and attach advanced monogramming foot “N+”.

3 Set the needle in the fabric at the sewing start point, and sew seam “1” as shown.

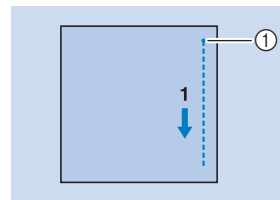

① Start Point

4 Select and sew seam “2” as shown.

* The fabric will move sideways, guide the fabric by hand to keep sewing straight.

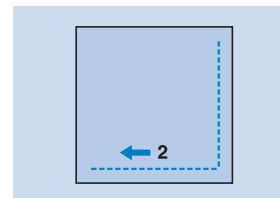

- 5 Select  and sew seam "3" as shown.

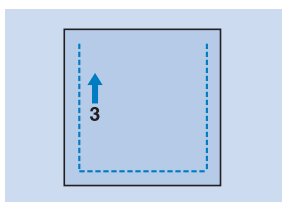

→ The fabric feeds forward while stitching backward.

- 6 Select  and sew seam "4" as shown.

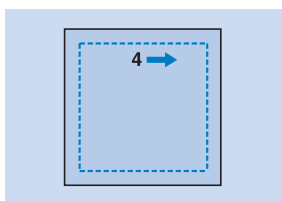

→ The seam will be connected to the starting point of seam 1.

Zipper Insertion

Centered Zipper

Use for bags and other such applications.

Memo

- For details on stitch patterns, refer to "STITCH SETTING CHART" on page 197.

Note

- Make sure you sew using the middle needle position.

- 1 Select .

- 2 Attach presser foot "J" and sew straight stitches up to the zipper opening. Change to a basting stitch (page 68) and sew to the top of the fabric.

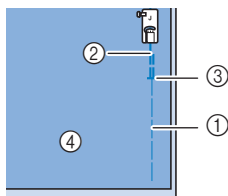

- ① Basting stitches
- ② Reverse stitches
- ③ End of zipper opening
- ④ Wrong side

- 3 Press the seam allowance open and attach the zipper with a basting stitch in the middle of each side of the zipper tape.

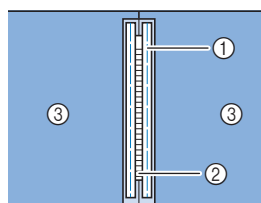

- ① Basting stitches
- ② Zipper
- ③ Wrong side

- 4 Remove presser foot "J". Align the right side of the pin in zipper foot "I" with the presser foot holder, and attach the zipper foot.

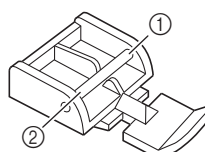

- ① Right
- ② Left
- ③ Needle drop point

Note

- When using zipper foot "I", make sure the straight stitch, middle needle position is selected. Rotate the handwheel toward you (counterclockwise) to make sure the needle does not strike the presser foot.

- 5 Topstitch 7 to 10 mm (approx. 1/4 to 3/8 inch) from the seamed edge of the fabric, then remove the basting.

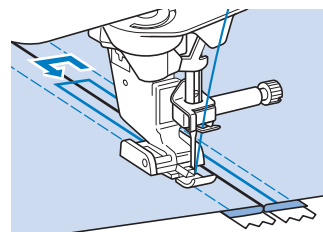

CAUTION

- Make sure the needle does not strike the zipper during sewing. If the needle strikes the zipper, the needle may break, leading to injury.

Inserting a Side Zipper

Use for side zippers in skirts or dresses.

- 1 Select .

Note

- Make sure you sew using the middle needle position.

- 2** Attach presser foot “J” and sew straight stitches up to the zipper opening. Change to a basting stitch and sew to the top of the fabric.

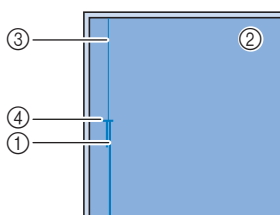

- ① Reverse stitches
- ② Wrong side of fabric
- ③ Basting stitches
- ④ End of zipper opening

- 3** Press the seam allowance open and align the folded hem along the teeth of the zipper, while maintaining 3 mm (approx. 1/8 inch) of sewing space.

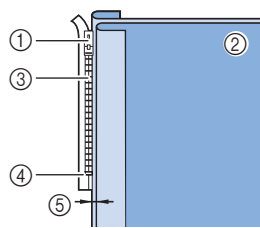

- ① Zipper pull tab
- ② Wrong side of fabric
- ③ Zipper teeth
- ④ End of zipper opening
- ⑤ 3 mm (approx. 1/8 inch)

- 4** Remove presser foot “J”.

- 5** Align the right side of the pin in zipper foot “1” with the presser foot holder, and attach the presser foot.

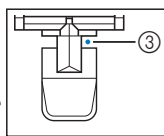
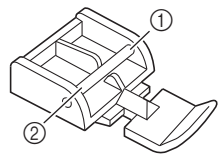

- ① Right
- ② Left
- ③ Needle drop point

- 6** Set the presser foot in the 3 mm (approx. 1/8 inch) margin.

- 7** Starting from the end of the zipper opening, sew to a point about 5 cm (approx. 2 inches) from the edge of the fabric, then stop the machine.

- 8** Pull down the zipper slider, then continue sewing to the edge of the fabric.

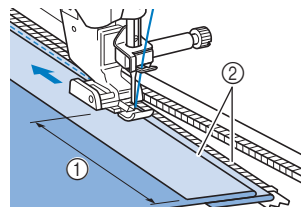

- ① About 5 cm (approx. 2 inches)
- ② 3 mm (approx. 1/8 inch)

- 9** Close the zipper, turn the fabric over, and sew a basting stitch.

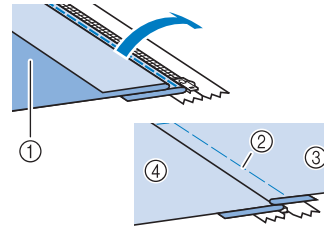

- ① Front of the skirt (wrong side of fabric)
- ② Basting stitches
- ③ Front of the skirt (right side of fabric)
- ④ Back of the skirt (right side of fabric)

- 10** Remove the presser foot, and reattach it so that the left side of the pin is attached to the presser foot holder.

* When sewing the left side of the zipper, the needle should drop on the right side of the presser foot. When sewing the right side of the zipper, the needle should drop on the left side of the presser foot.

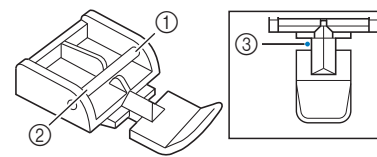

- ① Right
- ② Left
- ③ Needle drop point

- 11** Set the fabric so that the left edge of the presser foot touches the edge of the zipper teeth.

- 12** Sew reverse stitches at the top of the zipper, then continue sewing.

- 13** Stop sewing about 5 cm (approx. 2 inches) from the edge of the fabric, leave the needle in the fabric, and remove the basting stitches.

- 14** Open the zipper and sew the rest of the seam.

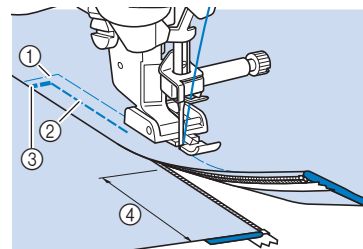

- ① Basting stitches
- ② 7 to 10 mm (approx. 1/4 inch to 3/8 inch)
- ③ Reverse stitches
- ④ About 5 cm (approx. 2 inches)

⚠ CAUTION

- Make sure the needle does not strike the zipper during sewing. If the needle strikes the zipper, the needle may break, leading to injury.

Changing the Start and End Angles of the Stitch Pattern (Stitch Tapering Function)

The angles of the start and end of stitch patterns can be changed. This is useful when sewing projects with sharply defined angles or decorative stitching, attaching appliques, etc.

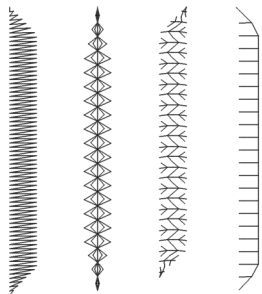

Use the method for finishing sewing the stitch pattern, according to your needs.

- Method 1: Begin Changing the Angle at the End of Sewing by Pressing the “Reverse Stitch” Button (page 93)
- Method 2: Sewing a Specified Number of Stitch Patterns (page 94)

Note

- Using the same material and stitch pattern as your project, sew trial stitches to check the result. If necessary, attach a stabilizer material.
- If reinforcement stitches at the beginning and end of sewing are needed, use (Reinforcement stitch button). (Reverse stitch button) cannot be used for reinforcement stitching when stitch tapering function is on.

Method 1: Begin Changing the Angle at the End of Sewing by Pressing the “Reverse Stitch” Button

- 1 Touch , then , and then select a stitch pattern for stitch tapering.

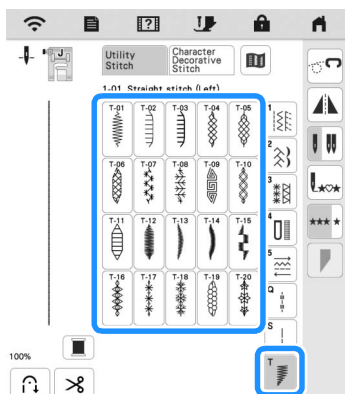

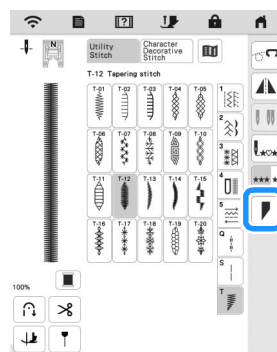

- 2 If necessary, change the stitch width and stitch length.
- 3 Touch .



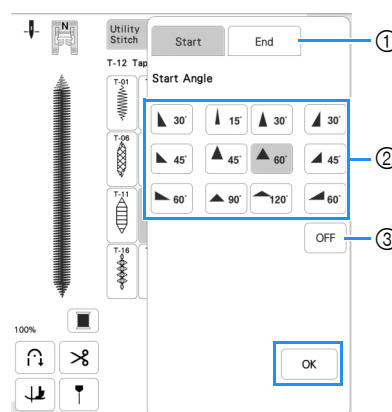
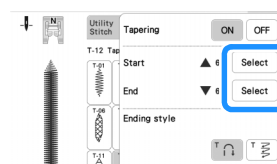

- 4 Touch , select the angle settings for the start and end of sewing, and then touch .

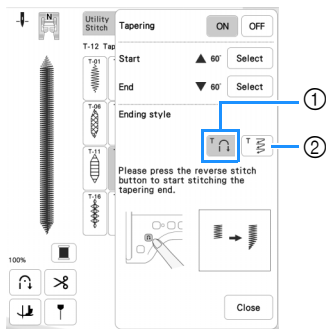

- ① Select the start or end of sewing.
- ② Select an angle.
- ③ Specify that the angle does not change.

- 5** Select the method for finishing sewing. For this example, since the angle at the end of sewing will begin changing when  (Reverse stitch button) is pressed, select .





- ① Press  (Reverse stitch button) for the angle at the end of sewing to start changing; the machine stops when sewing is finished.
- ② The machine stops when the specified number of stitch patterns have been sewn. The number of patterns that are specified includes the number of patterns used to change the angle. (page 94)

- 6** If necessary, use a chalk pencil to draw a line at the location to be sewn.

- 7** Start sewing.

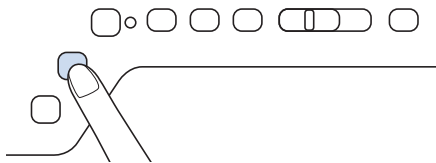
- 8** After sewing the desired length, press  (Reverse stitch button).



→ When  (Reverse stitch button) is pressed, the angle at the end of sewing begins to change, and the machine stops when sewing is finished.

Memo

- If you stop sewing at the point where end tapering should begin (either by pressing the “Start/Stop” button or by lifting your foot from the foot controller), press  (Reverse stitch button) and resume sewing by either pressing the “Start/Stop” button or pressing on the foot controller. End tapering will begin as soon as sewing resumes.

- 9** When finished sewing, set [Tapering] to [OFF], and then touch .

Method 2: Sewing a Specified Number of Stitch Patterns

With this method, the number of stitch patterns (including those used to change the angle) are specified. This allows stitch patterns of the same length to be repeatedly sewn.

- 1** Refer to steps **1** through **4** of “Method 1: Begin Changing the Angle at the End of Sewing by Pressing the “Reverse Stitch” Button” on page 93 to select the angle settings for the start and end of sewing.

- 2** Touch , and then specify the number of stitch patterns (including those used to change the angle).

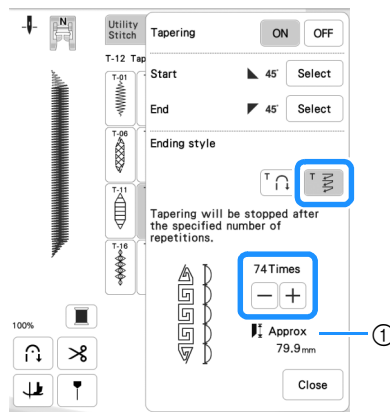

- ① Approximate length of the stitch pattern



Memo

- The number of stitch patterns used to change the angle depends on the pattern and angle. Perform trial sewing to check the result.

- 3** Start sewing.

→ The machine stops automatically when sewing is finished.

Memo

- To sew stitching in a square, select  for the start of sewing and  for the end of sewing, and then continue sewing the same stitch pattern, rotating the fabric 90° after sewing each line of stitching.

The pivot setting is useful when changing the sewing direction. (page 61)

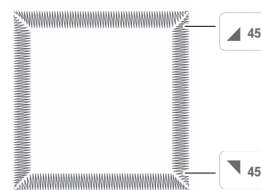

■ Saving Settings

Specified angles for start and end, finish tapering method, and stitch settings can be saved in machine's memory.

- 1 After setting the tapering function, touch **Close**.

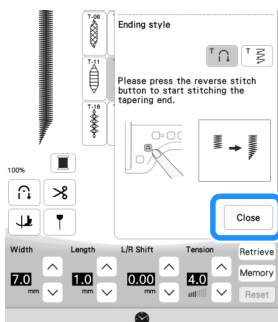

- 2 Touch **Memory**.

■ Retrieving Saved Settings

- 1 Touch **Retrieve** to retrieve the saved setting after selecting pattern.
- 2 Touch the numbered key of the settings to be retrieved and then touch **Retrieve**.

* The settings cannot be retrieved if stitch tapering function is set to [ON].

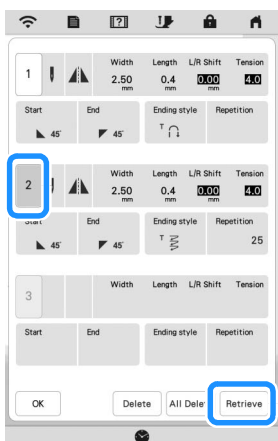





📖 Memo

- For more information on saving and recalling settings, refer to "Saving Your Stitch Settings" on page 59.



MAKING ADJUSTMENTS

Your stitch pattern may sometimes turn out poorly, depending on the type or thickness of fabric, the stabilizer material used, sewing speed, etc. If your sewing does not turn out well, sew trial stitches using the same conditions as the real sewing, and adjust the stitch pattern as explained below. If the stitch pattern does not turn out well even after making adjustments based on the stitch pattern described below, make adjustments for each stitch pattern individually.

📖 Memo

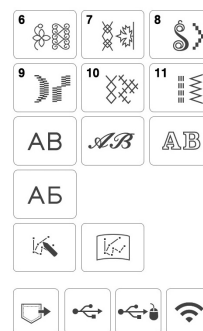
- For details on stitch patterns, refer to "STITCH SETTING CHART" on page 197.
- This adjustment can be made to  (1-36 Quilting stippling stitch),  (2-21 Decorative stippling stitch),  (4-24 Eyelet stitch),  (4-25 Star eyelet stitch),  (Q-15 Quilting stippling stitch) and stitch patterns from the following categories.



- 1 Touch  and select  (6-284).
- 2 Attach advanced monogramming foot "N+" and sew the stitch pattern.
Be sure to use advanced monogramming foot "N+". Adjustments may not be made correctly with any other presser foot.
- 3 Compare the finished stitch pattern to the illustration of the correct stitch pattern below.

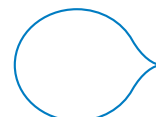

- 4 Touch  , and then adjust the stitch pattern with the [Fine Adjust Verti.] or [Fine Adjust Horiz.] displays.



- If the stitch pattern is bunched:

Touch **+** in the [Fine Adjust Verti.] display.
 → The displayed value increases each time the button is touched and the stitch pattern will lengthen.

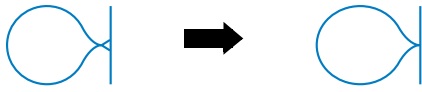

- If the stitch pattern has gaps:

Touch **-** in the [Fine Adjust Verti.] display.
 → The displayed value decreases each time the button is touched and the stitch pattern will shorten.

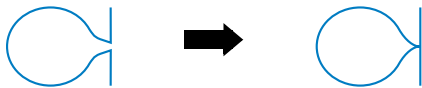

- If the stitch pattern is skewed to the left:

Touch **+** in the [Fine Adjust Horiz.] display.
 → The displayed value increases each time the button is touched and the stitch pattern will slide to the right.

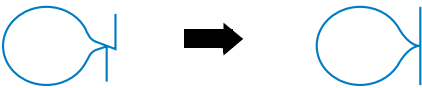

- If the stitch pattern is skewed to the right:

Touch **-** in the [Fine Adjust Horiz.] display.
 → The displayed value decreases each time the button is touched and the stitch pattern will slide to the left.



5 Sew the stitch pattern again.

* If the stitch pattern still comes out poorly, make adjustments again. Adjust until the stitch pattern comes out correctly.

Memo

- You can sew with the setting screen on the display.

6 Touch **OK to return to the original screen.**

MAKING STEP STITCH PATTERNS (FOR 7MM SATIN STITCH PATTERNS ONLY)

You can use **↶** **↷** keys to create a step effect, also called step stitch patterns.

- Touch **↶** **↷** to move the stitch pattern a distance equal to half of the stitch pattern's size to the left or right.
- To combine the stitch patterns, refer to page 53.

Example:



- 1** Select  (9-11).
- 2** Touch **+** so that it displays **+**.
- 3** Touch **↷**.



→ The next stitch pattern will move to the right.

- 4** Select  (9-11) again.

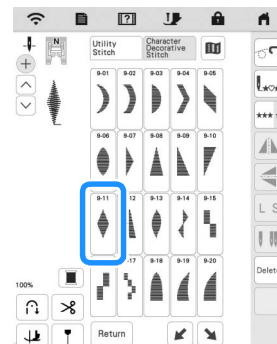

5 Touch .



→ The next stitch pattern will move to the left.

6 Touch .

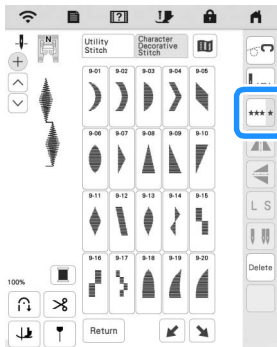

→ The entered stitch pattern is repeated.

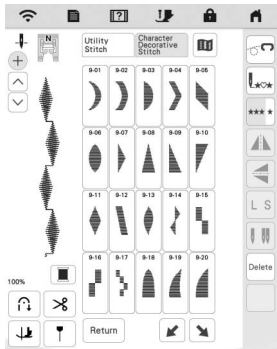

USING THE MEMORY FUNCTION

Memo

- For more information about the memory function, refer to “SPECIFICATIONS” on page 194.

Saving Stitch Patterns

You can save stitch patterns that you have customized in the machine's memory or USB media.

Note

- Do not turn the main power to OFF while the [Saving...] screen is displayed. You will lose the stitch pattern you are saving.

1 Touch .



2 When saving the stitch pattern in a USB media, insert the USB media into the USB port on the machine.

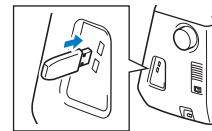

3 Touch the desired destination to start saving.



- ① Save to the machine's memory.
- ② Save to the USB media.
The stitch pattern is saved in a folder labeled [bPocket].

Retrieving Stitch Patterns

Retrieve stitch patterns saved in the machine's memory or USB media.

1 When retrieving stitch patterns from a USB media, insert the USB media into the USB port on the machine.

2 Touch the desired destination.

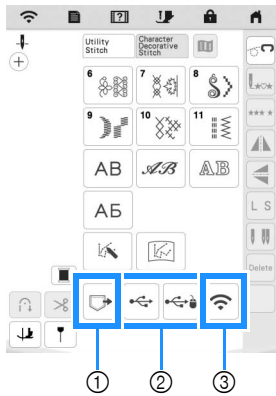



- ① Retrieve from the machine's memory.
- ② Retrieve from a USB media.
When retrieving stitch patterns from a USB media, insert the USB media into the USB port on the machine.
- ③ Retrieve via the wireless network.

Memo

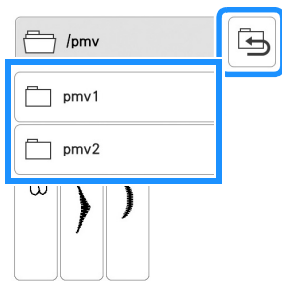
- If the stitch pattern to be retrieved is in a folder of the USB media, touch the key for that folder. Touch  to return to the previous screen.



- Folders in the USB media cannot be created with the machine.
- Touch  to retrieve stitch patterns via the wireless network. For detailed procedures, refer to PE-DESIGN manual (Version 11 or later).
- For details on supported file extensions, refer to "SPECIFICATIONS" on page 194.

3 Select the desired stitch pattern, and then touch .

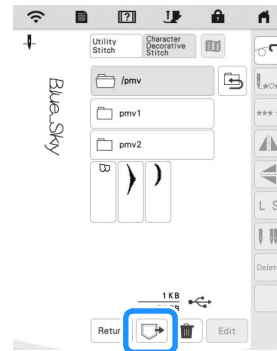

Note

- When you touch , the selected stitch pattern will be deleted permanently.

MY CUSTOM STITCH

■ Designing a Stitch

By using the MY CUSTOM STITCH function, you can register stitches you have created yourself. You can also sew designs combining MY CUSTOM STITCH creations with built-in characters (page 53).

Memo

- Stitches that you create with MY CUSTOM STITCH can be a maximum of 7 mm (approx. 9/32 inch) wide and 37 mm (approx. 1-1/3 inches) long.

- Draw the stitch design on the grid sheet. Place points where the stitch pattern intersects with the grid, and connect all the points with a line.

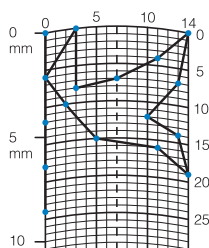

Memo

- Simplify the design so that it can be sewn as a continuous line. For a more attractive stitch, close the design by intersecting lines.



If the design is to be repeated and linked, the start point and end point of the design should be at the same height.

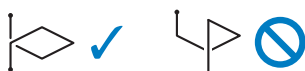

- Determine the x and y coordinates of each of the marked points.

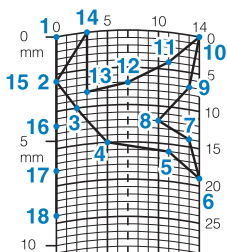



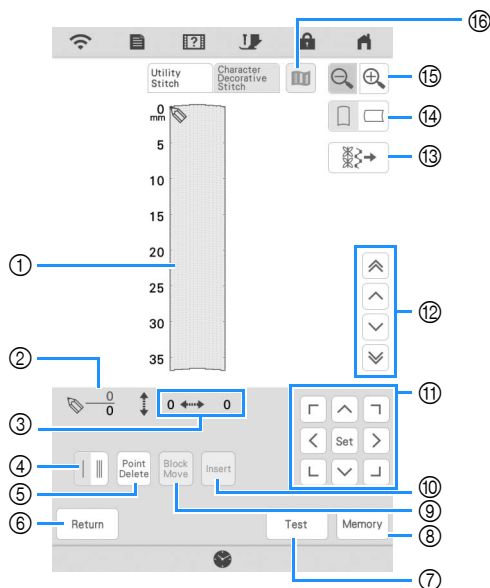



■ MY CUSTOM STITCH Screen



- This area displays the stitch being created.
- Displays the number of the present set point over the total number of points in the stitch.
- Displays the y-coordinate of over the x-coordinate of .



No.	Display Key Name	Explanation	Page
④	Single/triple stitching key	Touch this key to select whether one or three stitches will be sewn between two points.	100
⑤	Point delete key	Touch this key to delete a selected point.	—
⑥	Return key	Touch this key to exit the entering stitch data screen.	—
⑦	Test key	Touch this key to sew a test of the stitch.	—
⑧	MY CUSTOM STITCH memory key	Touch this key to store the stitch being created.	—
⑨	Block move key	Touch this key to group points together and move them together.	100
⑩	Insert key	Touch this key to insert new points on the stitch design.	101
⑪	Arrow keys and set key	Use these keys to move over the display area, and touch the set key in the center to set a point on the stitch design.	100-101

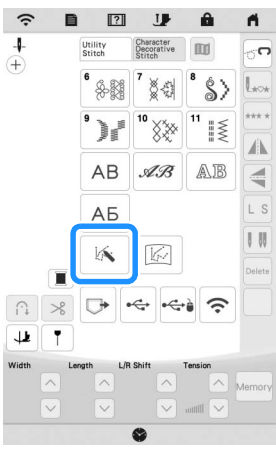

No.	Display	Explanation	Page
	Key Name		
12	 Point-to-point key	Use these keys to move  from point to point on the stitch, or to the first or last point entered on the stitch.	100
13	 Stitch edit key	Touch this key to edit the utility stitches in the machine.	—
14	 Grid direction key	Touch this key to change the direction of the grid sheet.	—
15	 Enlarger key	Touch this key to see an enlarged version of the stitch being created.	—
16	 Image key	Touch this key to view an image of the stitch.	—

1 Touch  and then  .

2 Touch  .



3 Use  to move  to the coordinates of the first point on the grid.

4 Touch  to add the point indicated by  .

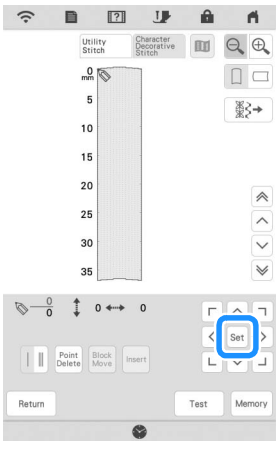

5 Select whether single stitch or triple stitches will be sewn between the first two points.

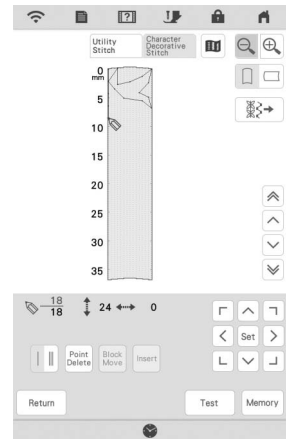

* To sew three stitches, touch the key so that it appears as  .

6 Repeat the steps for each point that you have drawn on the grid sheet until the stitch design is drawn on the screen as a continuous line.





7 Once you finish entering the stitch data, touch  to save the stitch pattern.

■ Moving a Point



1 Touch  to move  to the point that you want to move.

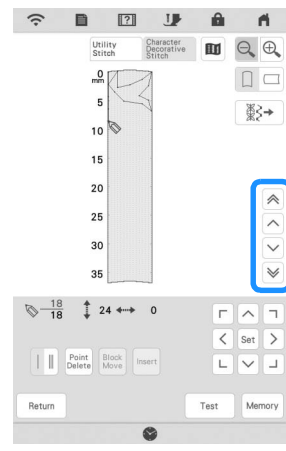

2 Use  to move the point.

■ Moving Part or All of the Design

1 Touch  to move  to the first point of the section that you want to move.



* To move  to the first point, touch  .

* To move  to the last point, touch  .

2 Touch  .

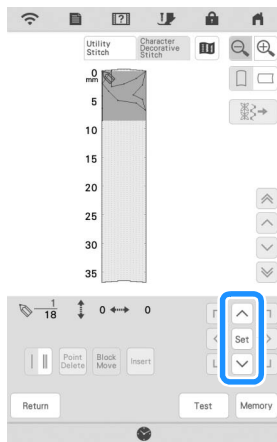

→ The selected point and all points that were entered after it are selected.

3 Touch  or  to move the section and touch  .





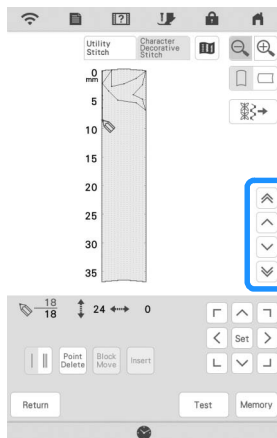

→ The section will be moved.

■ Inserting New Points

1 Touch  or  to move  to a place on the design where you want to add a new point.



* To move  to the first point, touch  .

* To move  to the last point, touch  .

2 Touch  to insert a new point.

3 Use  to move the point.

Retrieving Saved Stitch Patterns

1 Touch  .

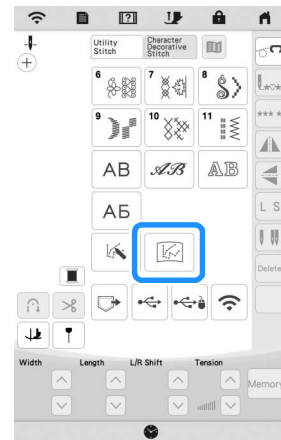

2 Select the device to retrieve the stitch pattern from.



3 Select the stitch pattern.

* You can start sewing when this screen is displayed.

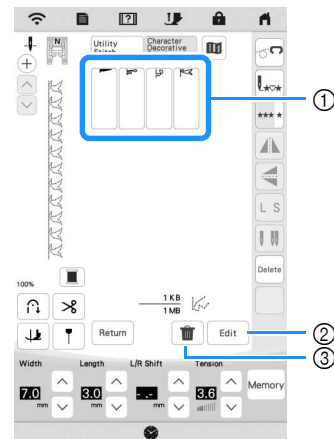

- ① Stored stitch patterns
- ② Edit the stitch pattern.
- ③ Delete the stitch pattern.

Chapter 4 BASIC EMBROIDERY

BEFORE EMBROIDERING

Embroidery Step by Step

Follow the steps below to prepare the machine for embroidery.

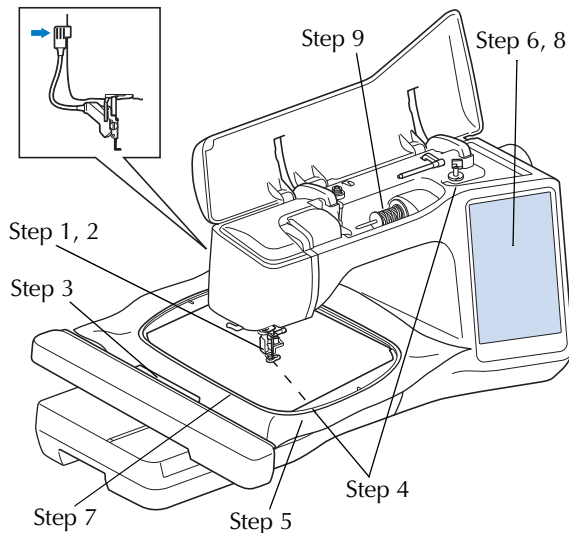

Step #	Aim	Action	Page
1	Presser foot attachment	Attach embroidery foot "W+" with LED pointer.	103
2	Checking the needle	Use needle 75/11 for embroidery.	42
3	Embroidery unit attachment	Attach the embroidery unit.	104
4	Bobbin thread setup	For the bobbin thread, wind embroidery bobbin thread and set it in place.	30
5	Fabric preparation	Attach a stabilizer material to the fabric, and hoop it in the embroidery frame.	126
6	Pattern selection	Turn the main power to ON, and select an embroidery pattern.	105
7	Embroidery frame attachment	Attach the embroidery frame to the embroidery unit.	129
8	Checking the layout	Check and adjust the size and position of the embroidery.	130
9	Embroidery upper thread setup	Set up embroidery upper thread according to the pattern.	36

Attaching Embroidery Foot "W+" with LED Pointer

⚠ CAUTION

- When attaching an embroidery foot, always touch  on the screen. You may accidentally press the "Start/Stop" button and possibly cause injury.
- Be sure to use the embroidery foot "W+" with LED pointer when doing embroidery. Using another embroidery foot may cause the needle to strike the embroidery foot, causing the needle to break and possibly causing injury.

- 1 Remove the presser foot and presser foot holder. (page 45)
- 2 Position the embroidery foot "W+" with LED pointer on the presser foot bar by aligning the notch of the presser foot to the large screw.

Side view

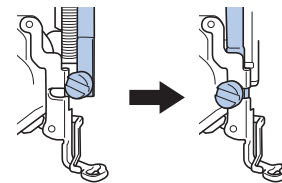

- 3 Hold the embroidery foot in place with your right hand, and then use the disc-shaped screwdriver to securely tighten the presser foot holder screw.

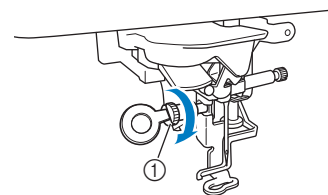



① Presser foot holder screw

⚠ CAUTION

- Use the disc-shaped screwdriver to firmly tighten the presser foot holder screw. If the screw is loose, the needle may strike the embroidery foot and break, possibly cause injury.

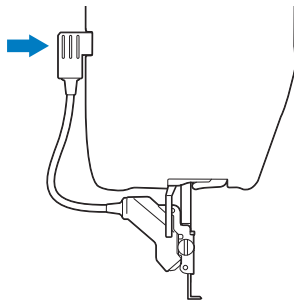
- 4 Plug the connector of the embroidery foot “W+” with LED pointer into the jack on the back left side of your machine.



- 5 Touch  to unlock all keys and buttons.
→ All keys and operation buttons are unlocked, and the previous screen is displayed.

About the Embroidery Unit

CAUTION

- Do not move the machine with the embroidery unit attached. The embroidery unit could fall off and cause injury.



IMPORTANT

- Keep your hands and foreign objects away from the embroidery carriage and frame when the machine is embroidering. Damage or malfunction may result.
- Be sure to turn off the power before attaching or removing the embroidery unit. Otherwise, the machine may be damaged.
- Do not touch the inner connector of the embroidery unit. The pins on the embroidery unit connection may be damaged.
- Do not apply strong force to the embroidery unit carriage or pick up the unit by the carriage. Otherwise, the embroidery unit may be damaged.
- Do not push on the carriage when attaching the embroidery unit onto the machine. Moving the carriage may damage the embroidery unit.
- Make sure that there is enough space for the carriage of the embroidery unit to move. If the embroidery frame comes into contact with an object, the pattern may not be embroidered correctly, or damage may result.
- Do not touch the embroidery carriage until the initialization finishes.

Note

- To avoid distorting your embroidery design, do not touch the embroidery carriage and frame when the machine is embroidering.
- Store the embroidery unit in a safe place to prevent damage to the unit.

Memo

- You can also sew utility/decorative stitches with the embroidery unit attached. Touch  and . The feed dogs will automatically raise for utility and decorative stitching.

■ Attaching the Embroidery Unit

- 1 Turn the main power to OFF, and remove the flat bed attachment.

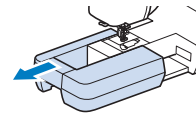

- 2 Insert the embroidery unit connection into the connection port of the machine until it snaps into place.

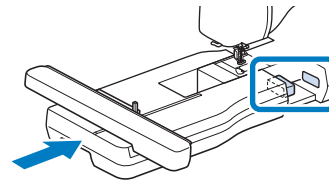

Note

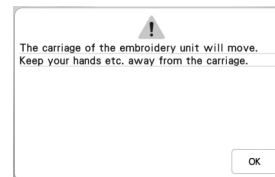

- Be sure there is no gap between the embroidery unit and the machine. If there is a gap, the embroidery patterns will not embroider with the correct registration.

- 3 Turn the main power to ON.
→ The following message will appear.



- 4 Touch  .
→ The carriage will move to the initialization position.

■ Removing the Embroidery Unit

- 1 Remove the embroidery frame.
 - For details on removing the embroidery frame, refer to “Removing the Embroidery Frame” on page 129.
- 2 Touch , then touch .

→ The carriage will move to the removal position.
- 3 Turn the main power to OFF.
- 4 Press the release button, and pull the embroidery unit away from the machine.

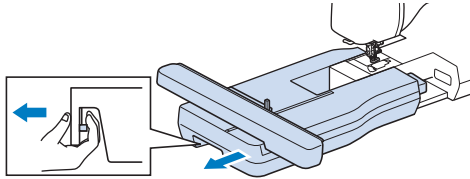

SELECTING PATTERNS

■ Copyright Information

The patterns stored in the machine and patterns sold separately are intended for private use only. Any public or commercial use of copyrighted patterns is an infringement of copyright law and is strictly prohibited.

■ About Embroidery Patterns

There are many character and decorative embroidery patterns stored in the machine's memory (see the “Embroidery Design Guide” for a full summary of patterns in the machine's memory or visit <https://s.brother/cmekb/>). You can also use patterns sold separately.

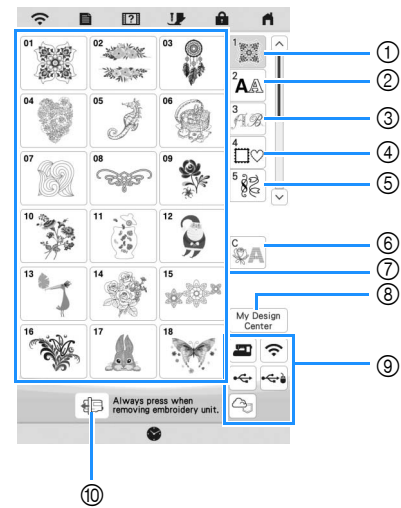

- ① Embroidery patterns
- ② Character patterns
- ③ Decorative alphabet patterns
- ④ Frame patterns
- ⑤ Utility embroidery patterns
- ⑥ Couching patterns (page 156)
- ⑦ Pattern type selection keys
- ⑧ My Design Center (page 161)
- ⑨ Patterns saved in the machine's memory, USB media, etc. (page 154)
- ⑩ Touch this key to position the embroidery unit for storage.

Selecting Embroidery Patterns

1 Touch the category tab and then touch the pattern type selection key or pattern key you want to embroider.

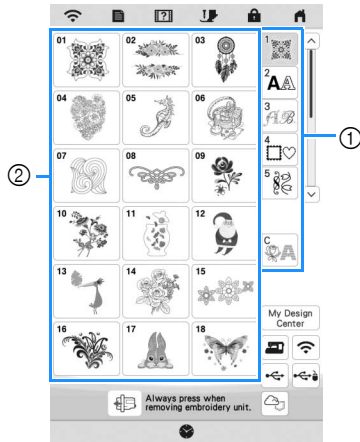

- ① Pattern category tab
- ② Pattern type/pattern selection key

2 Select a pattern.

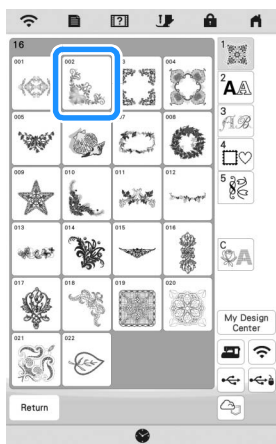

- * Touch the category tab or to return to the previous screen.
- The selected pattern is displayed.

3 Touch to set the pattern.



- * Touch to darken the background color for the pattern image with bright thread colors, to get a clearer image.

→ The pattern is designated with a red box around it on the edit screen.

4 Touch to edit the selected pattern. (page 111)

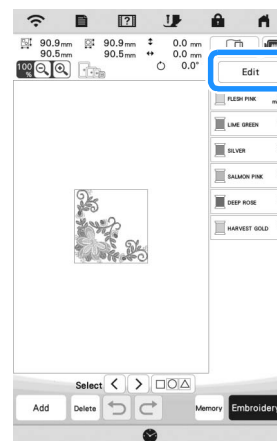

5 Touch .

→ The embroidery screen appears.

- 6 Touch **Layout** to edit the pattern before embroidering. (page 124)

* To return to the edit screen, touch **Return**.

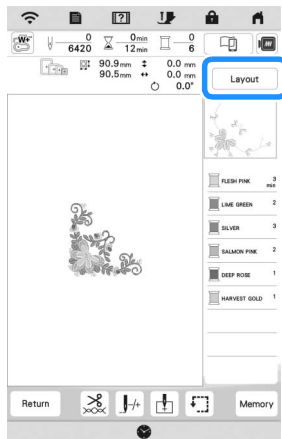



- 7 Start embroidering. (page 138)

Selecting Character Patterns

- 1 Touch **AA**.

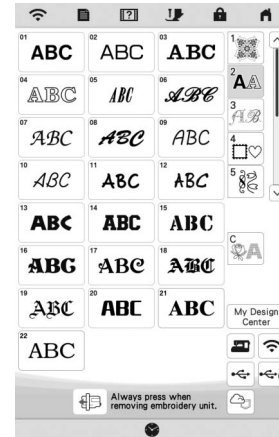
- 2 Touch the key of the font you want to embroider.



*  : View the next page.

 : View the previous page.

- 3 Select the character category and then type in the text. (page 108)



- 4 Touch **Set**.

→ The edit screen appears.

- 5 Follow the steps from 4 to 7 of "Selecting Embroidery Patterns" on page 106.

■ Character Pattern Input Keys

Memo

- If a key display is grayed out, you cannot use that function with the selected pattern.

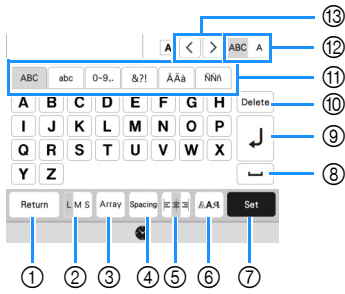

No.	Display	Explanation
	Name	
①		Return to the previous screen.
	Return key	
②		Change the size of the character patterns. To change the size of one character, touch to display and then select the character. The size of the selected character is changed.
	Size key	
③		Change the configuration of the character patterns. <ul style="list-style-type: none"> • To arrange the character patterns on an arc, touch , , or . <ul style="list-style-type: none"> : Make the arc flatter. : Make the arc rounder. • To arrange the character patterns on an incline, touch . <ul style="list-style-type: none"> : Change the incline counterclockwise. : Change the incline clockwise. • : Reset the layout.
	Array key	
④		Change the spacing of the character patterns. <ul style="list-style-type: none"> • : Increase the character spacing. • : Decrease the character spacing. • To change the spacing after one character, touch to display and then select the character. The spacing between the selected character and the next character is changed. ABCD E ↔ ABCDE A B C D E ↔ ABCDE • : Move the one selected character up. • : Move the one selected character down. • : Reset the spacing.
	Character spacing key	

No.	Display	Explanation
	Name	
⑤		Switch alignment. This function is available when multiple lines of characters are input. <ul style="list-style-type: none"> • : Right alignment • : Left alignment • : Center alignment
	Alignment key	
⑥		Change the font of the characters. Depending on the font that was selected, it may not be possible to change the font. <ul style="list-style-type: none"> • To change the font of one character, touch to display and then select the character. The font of the selected character is changed.
	Font Type key	
⑦		Apply the character pattern editing.
	Set key	
⑧		Enter a space.
	Space key	
⑨		Make a new line.
	Line feed key	
⑩		Delete the character.
	Delete key	
⑪		Select the category of character.
	Category keys	
⑫		Select to edit all characters or one character. <ul style="list-style-type: none"> • : Edit all characters. • : Edit one character.
	Select one/all key	
⑬		Move the cursor and select a character.
	Character selection keys	

Selecting Frame Patterns

- 1 Touch .
- 2 Touch the key of the frame shape you want to embroider in the top part of the screen.

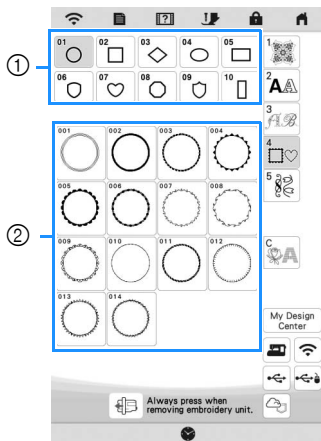

- ① Frame shapes
- ② Frame patterns



→ Various frame patterns are displayed at the bottom part of the screen.

- 3 Touch the key of the frame pattern you want to embroider.
→ The selected pattern is displayed on the screen.
- 4 Touch .
- 5 Follow the steps from 4 to 7 of "Selecting Embroidery Patterns" on page 106.





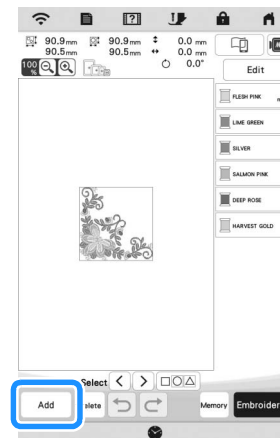

Combining Patterns

Example:



- 1 Select a pattern and then touch .
- 2 Touch .



- 3 Touch .
- 4 Select  and enter "LOVE".
→ The characters you enter will be displayed in the center of the embroidery pattern area.
- 5 Touch .
- 6 Touch  and then touch .
- 7 Use  to move the characters.
* Characters can also be moved by directly dragging them with your finger or the touch pen.

8 Touch  .

9 Touch  to change the color of the characters.
(page 120)

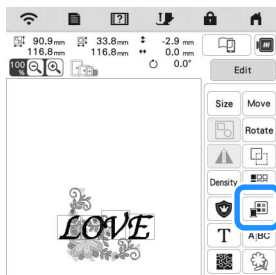

10 Touch  .



11 When all editing is finished, touch  .

 **Memo**

- Combined patterns will be embroidered in the order they were entered.

■ **Selecting a Pattern**

If multiple patterns have been combined, use

  to select the pattern to be edited. Patterns can also be selected by directly touching the screen with your finger or touch pen.

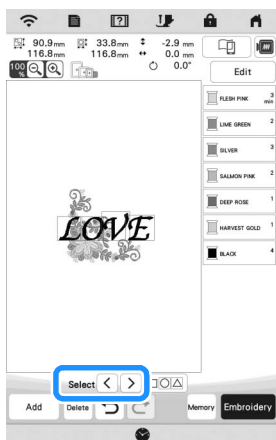

■ **Selecting Multiple Patterns at the Same Time**





Multiple patterns can easily be edited, for example, when moving patterns, if they are all selected together.

1 Touch  .

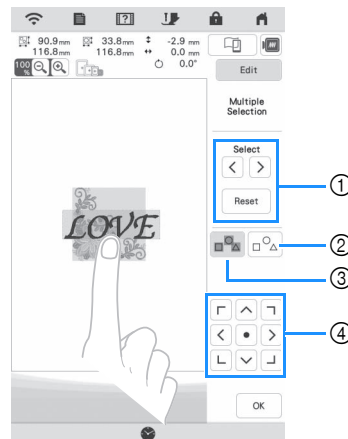

2 Touch each pattern to be selected.



- 1 Touch  or  to check the patterns to be selected, and then touch  . The selected patterns are highlighted with a red box. To deselect the selected patterns, touch  .
- 2 Touch this key to deselect all selected patterns.
- 3 Touch this key to select all patterns in the pattern display area.
- 4 Patterns can be moved with this key.

 **Memo**

- You can also select multiple patterns by dragging your finger to specify the area of selection.

3 Touch  to return to the edit screen.

→ Each selected pattern is surrounded with a red box.

 **Memo**

- The following functions are available while multiple patterns are selected.
 - Moving
 - Copying
 - Grouping
 - Stippling
 - Extracting pattern outlines

■ Grouping Patterns

If the multiple patterns are grouped, they can be edited as a single pattern.

1 Select patterns you want to group. (page 110)

2 Touch .

→ The selected patterns are grouped.

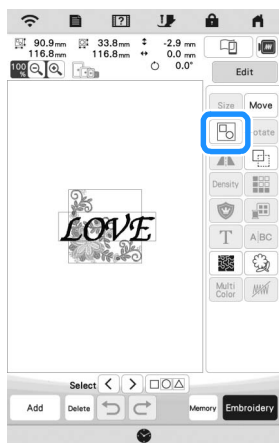

* To ungroup a grouped pattern, select the grouped pattern, and then touch . At this time, multiple patterns are selected. To cancel the multiple selection, touch any other pattern or the blank area.

Memo

- The following functions are applied to all patterns in the grouped pattern.
 - Moving
 - Rotating
 - Appliqué
 - Border
 - Extracting pattern outlines
 - Simple stippling
 - Thread color changing

EDITING PATTERNS

Using these keys, you can edit the pattern as you like.

Memo

- If a key display is grayed out, you cannot use that function with the selected pattern.

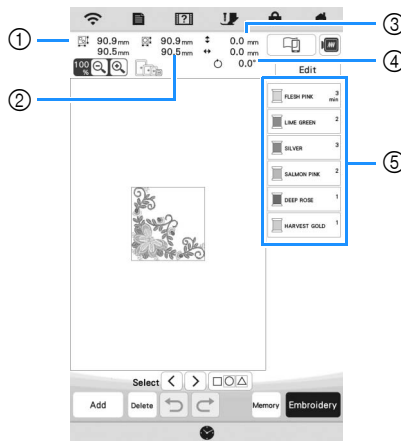







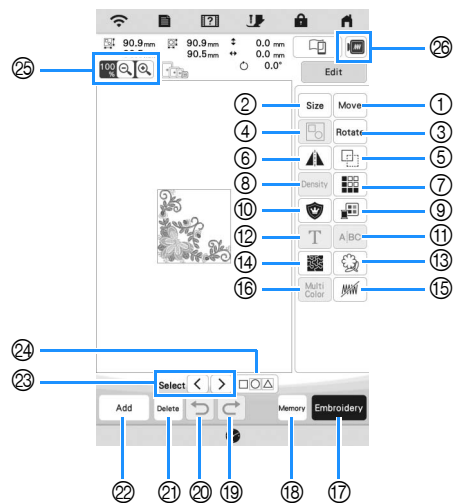





















- ① Size of the entire combined pattern
- ② Size of the pattern currently selected
- ③ Distance from the center of the frame to the center of the pattern currently selected
- ④ Degree of rotation for the pattern currently selected
- ⑤ Color sequence and stitching times of each step of the pattern

















■ Key Functions

Touch  to display the editing window.



No.	Display	Explanation	Page
	Name		
①	 Move key	Display the pattern moving window. •    : Move the pattern in the direction shown by the arrow. •  : Center the pattern.	109

No.	Display	Explanation	Page
	Name		
②		Display the pattern sizing window. •  : Decrease the pattern proportionately. •  : Decrease the pattern vertically. •  : Decrease the pattern horizontally. •  : Enlarge the pattern proportionately. •  : Stretch the pattern vertically. •  : Stretch the pattern horizontally. •  : Change the size of the character patterns. •  : Reset the size. (except for character patterns.)  •  : Move the pattern in the direction shown by the arrow. 	114
	Size key		
③		Display the pattern rotating window. •  : Reset the position.  •  : Move the pattern in the direction shown by the arrow. You can also rotate the pattern by dragging the red point at the corners of the pattern.	—
	Rotate key		
④		Group selected multiple patterns.	111
	Group key		
⑤		Duplicate the pattern.	—
	Duplicate key		
⑥		Change the pattern to a horizontal mirror image.	—
	Horizontal mirror image key		
⑦		Make and edit the repeated pattern.	114
	Border key		
⑧		Allows the thread density to change for some Alphabet characters and frame patterns. Other patterns density can be modified after the pattern size is changed.	114
	Density key		
⑨		Change the thread color.	121
	Thread palette key		
⑩		Create an appliqué outline of the pattern.	144
	Appliqué key		

No.	Display	Explanation	Page
	Name		
⑪		Separate the continuous character patterns to adjust the spacing or edit separately afterwards. •  : Select where the patterns is to be separated. •  : Separate the patten. A separated character pattern cannot be combined again.	—
	Separate key		
⑫		Edit character patterns.	108, 113
	Letter Edit key		
⑬		Extract the outline of the pattern. The extracted pattern can be used with My Design Center.	176
	Outline key		
⑭		Touch this key to create stippling, echo quilting, or decorative fill around a pattern.	159
	Stippling key		
⑮		Touch this key to specify not to embroider the selected thread color.	119
	Deselect region setting (no sew setting) key		
⑯		Touch this key when you want to change the thread color, character by character in character embroidery. Since the machine stops at the end of each character, the upper thread can be changed as you embroider.	—
	Multi color key		
⑰		Proceed to the embroidery screen.	—
	Embroidery key		
⑱		Save a pattern in the machine's memory or USB media. The pattern can also be transferred to a computer via a wireless network connection.	153
	Memory key		
⑲		Redo the last operation that was undone.	—
	Redo key		
⑳		Undo the last operation.	—
	Undo key		
㉑		Delete the selected pattern (the pattern outlined by the red box).	—
	Delete key		
㉒		Add another pattern to the editing pattern.	109
	Add key		
㉓		Select the pattern to edit when there are multiple patterns.	110
	Pattern select key		
㉔		Make multiple patterns to be selected at the same time.	110
	Multiple selection key		

No.	Display	Explanation	Page
	Name		
25		<ul style="list-style-type: none"> : Magnify the image. Use /// to scroll through the display in any direction. : Demagnify the image (minimum: 100%). : Select the percent of magnification. 	—
	Magnify keys		
26		Preview the embroidered image.	113
	Image key		

■ Editing Letters

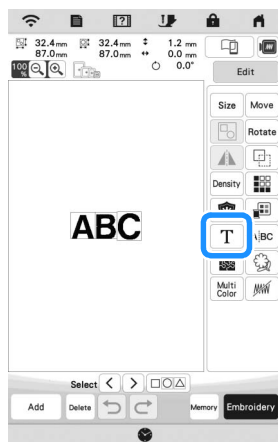

For details on input keys, refer to “Character Pattern Input Keys” on page 108.

Memo

- To edit character patterns with multiple lines in the edit screen, ungroup the pattern. (page 111)

Previewing the Pattern

- 1 Touch .



→ An image of the pattern as it will be embroidered appears.

- 2 Touch to select the frame used in the preview.

- * Frames displayed in gray cannot be selected.
- * Touch to enlarge the image of the pattern.
- * The pattern can be embroidered as it appears in the display.



- 3 Touch to check the embroidering order.

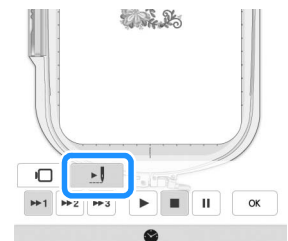

→ The stitch simulator screen appears.

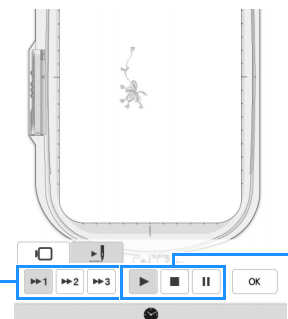



- ① Simulation speed keys
 - ② Operation keys
- : Start the simulation at the set speed.
 - : Pause the simulation.
 - : Stop the simulation.

* Touch  to return to the embroidery frame selection screen.

4 Touch  .

Changing the Size and the Density of the Pattern

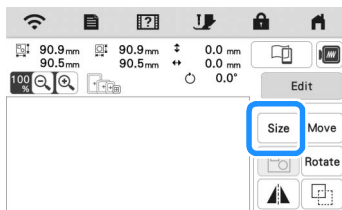

If  is selected, you can change the pattern size while maintaining the thread density. The machine recalculates the stitch density automatically. With this function, the pattern will be enlarged or reduced at a larger ratio than with normal pattern resizing.

1 Touch , and then touch  .

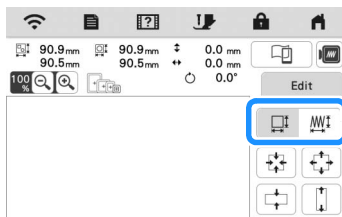

2 Select  in the size window.







- *  : Change the pattern size while maintaining the number of stitches. Enlarged patterns will be less dense, and reduced patterns will be more dense. In order to maintain embroidering quality, there is a limit to how much the embroidery pattern can be enlarged or reduced.
- *  : Change the pattern size while maintaining the thread density. After the pattern size is changed, the thread density can be changed in the edit screen. The number of stitches is recalculated depending on the pattern size.

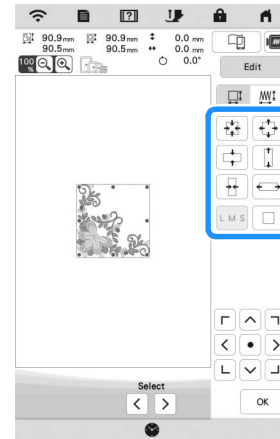

Memo

- This function cannot be used with alphabet character patterns, frame patterns, repeated patterns or buttonhole patterns.
- Patterns with a large number of stitches (100,001 or more) cannot be resized while maintaining a thread density.
- You can also change the size by dragging the red point at the sides and corners of the pattern.

3 Select the direction in which to change the pattern size.



4 When you select  in step 2, touch , and then touch  to change the thread density.

- *  : Make the pattern less dense.
- *  : Make the pattern more dense.

5 Touch  .



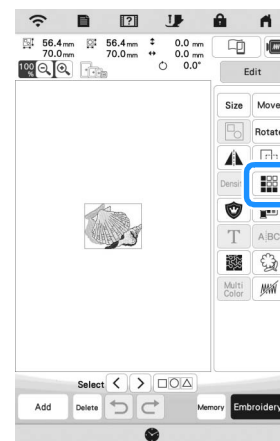

Creating Repeated Patterns

Using the border function, you can create repeated patterns. You can also adjust the spacing of the patterns.

1 Touch , and then touch  .



2 Select the direction in which the pattern will be repeated.

- *  : Repeat the pattern above.
- *  : Repeat the pattern below.
- *  : Delete above pattern.
- *  : Delete below pattern.

Vertical direction

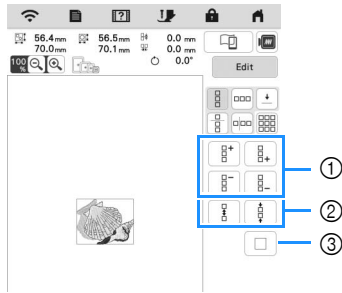

- ① Repeating and deleting keys
- ② Spacing keys
- ③ Key to cancel pattern repeating

Horizontal direction

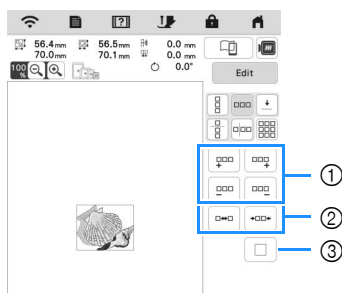

- ① Repeating and deleting keys
- ② Spacing keys
- ③ Key to cancel pattern repeating

3 Adjust the spacing of the repeated pattern.

- * : Widen spacing.
- * : Tighten spacing.

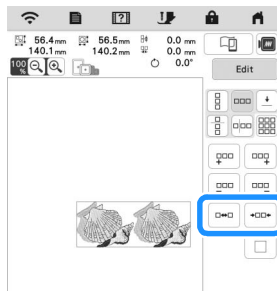

4 Complete repeated patterns by repeating steps through 3.

5 Touch .

■ Repeating Patterns Using the Matrix Copy

Place the pattern repeatedly throughout the embroidery area.

1 Touch .

2 Touch .



→ The repeated pattern is displayed positioned throughout the area.

3 Adjust the spacing of the repeated pattern.

- * : Widen spacing.
- * : Tighten spacing.

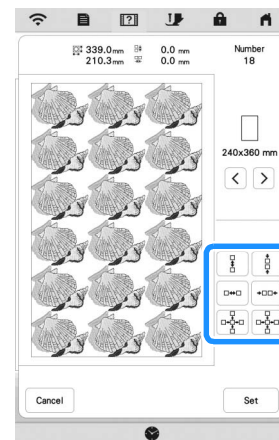

→ Every time the key is pressed, the pattern is automatically re-laid out.

4 Touch .

5 Touch .

■ Repeating One Element of a Repeated Pattern

You can select one element of a repeated pattern and repeat only that single element. This function allows you to create complex repeated patterns.

1 Touch .

2 Choose the direction in which the repeated pattern will be cut.

*  : Cut horizontally.

*  : Cut vertically.

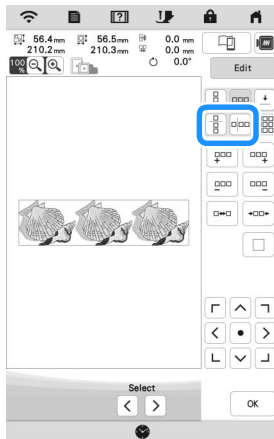

→ The pattern direction indicator will change depending on the direction selected.

3 Use  and  to select the cut line.

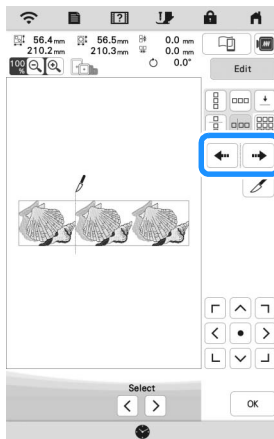

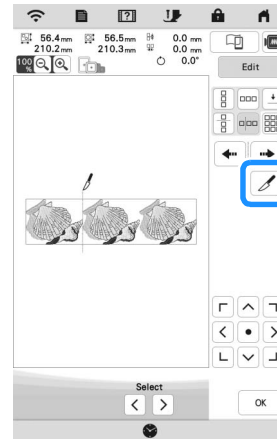

4 Touch .



→ The repeated pattern will be divided into separate elements.

5 Touch .

6 Use  and  to select the element to repeat.

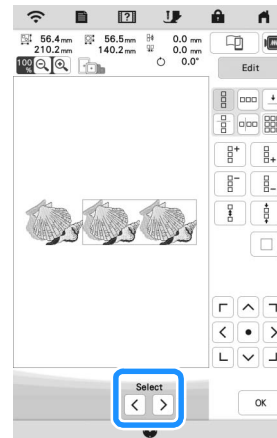

7 Repeat the selected element.

8 Touch .

Color Sorting Repeated Patterns

Touch **Embroidery** to automatically change the embroidering order of colors in combined border embroidery patterns so that the same color can be continuously embroidered. This allows you to continue embroidering without repeatedly changing the upper thread or changing the embroidering order manually.

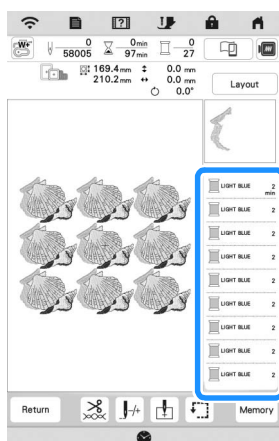
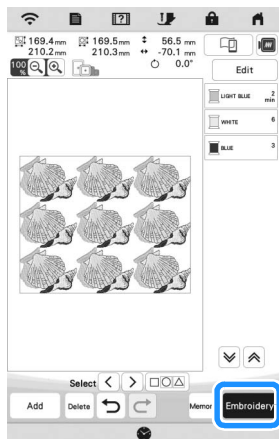

Memo

- When a grouped pattern is repeated, the embroidering order is changed in each pattern.
- If there are repeated patterns with other repeated patterns or other patterns, the embroidering order of only the repeated patterns is changed.

Assigning Thread Marks

By sewing thread marks, you can easily align patterns when rehooping the fabric to embroider a series. When embroidering is finished on a pattern, a thread mark in the shape of an arrow will be sewn using the final thread. When embroidering a series of patterns, use the point of this arrow for positioning the following designs to be embroidered.

1 Touch .

2 Touch .

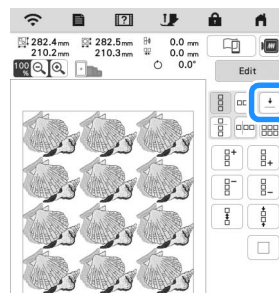

3 Touch to select the thread mark to be sewn.

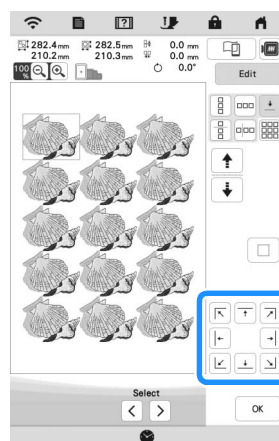

Memo

- When there are two or more elements, use or to select an element to assign a thread mark(s) to.

4 Touch .

Embroidering the Pattern Repeatedly

After creating the repeated pattern, rehoop the embroidery frame and keep embroidering for the next pattern.

- 1 Select the repeated pattern and assign the thread mark at the center of the bottom of the pattern.

* Refer to "Assigning Thread Marks" on page 117.

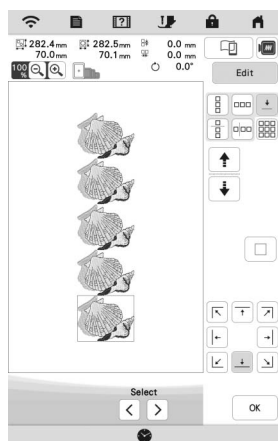

- 2 Touch **OK**, then **Embroider**.

- 3 Press the "Start/Stop" button to start embroidering.
→ When embroidering is finished, the thread mark is embroidered with the last thread color.

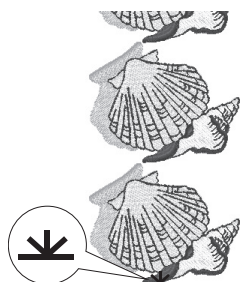

- 4 Remove the embroidery frame.

- 5 Rehoop the fabric in the embroidery frame.

Note

- Adjust the position of the fabric so that the embroidering area for the next pattern is within the embroidering area.

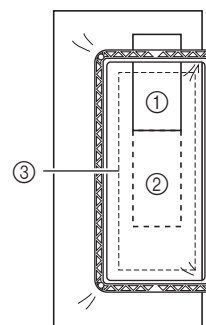

- ① Pattern embroidered first
- ② Position of pattern to be embroidered next
- ③ Embroidering area

- 6 Attach the embroidery frame to the machine, and then touch .

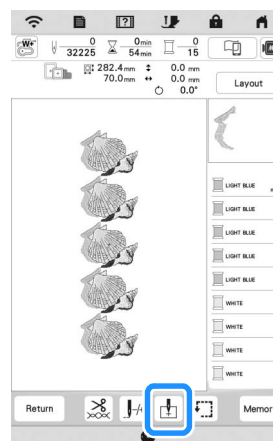

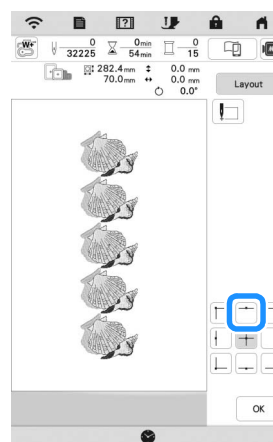

- 7 Touch  to set the starting point to the center top of the pattern.



- 8 Touch **OK**.

- 9 Touch **Layout**, and then touch **Move**.

- 10 Touch  to move the embroidery frame until the thread mark on the fabric is aligned with the light of the LED pointer.

* To check the needle drop point with the light of the LED pointer, touch .

 **Memo**

- For the accurate needle drop point, slowly turn the handwheel toward you (counterclockwise) to lower the needle. Then, turn the handwheel away from you (clockwise) until the mark on the handwheel is at the top. The carriage cannot move if the mark on the handwheel is not at the top.

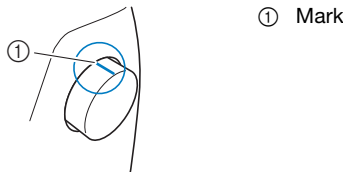

- 11 Touch .

- 12 Remove the thread mark.

- 13 Start embroidering.

Deselect Region Setting (No Sew Setting)

The deselect region setting (which specifies that a thread color will not be embroidered) can be applied to a part of the pattern with a specific color.

- 1 Touch  in the embroidering edit screen.

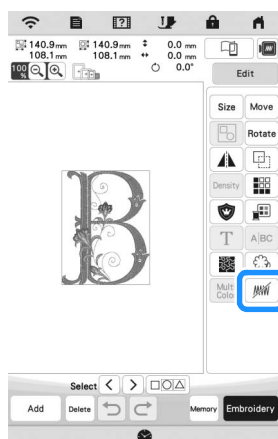

- 2 From the thread color sequence display, select the thread color that will not be embroidered.

→ The selected thread color is highlighted in blue.

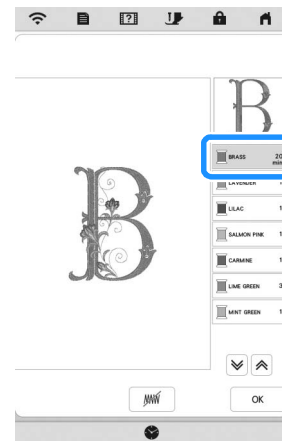



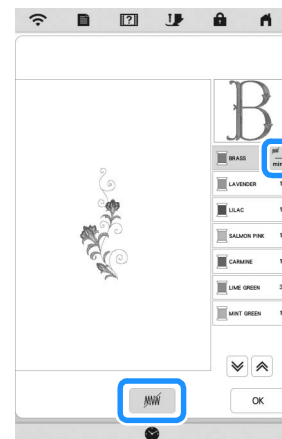

- 3 Touch .

→ The mark  appears to indicate that the selected thread color will not be embroidered. The parts of the pattern that will not be embroidered are hidden in the pattern preview screen.



 **Memo**

- To cancel the setting, select the thread color and touch .

- 4 If necessary, repeat steps 2 and 3 for all thread colors that will not be embroidered.
- 5 After specifying the desired settings, touch  .
- 6 Touch  and then touch  to check an enlarged image of the finished embroidery.
 - * After deselecting a region, check the image to be sure no previously hidden stitches are visible.



 **Memo**

- When a pattern with the deselect region setting applied is saved, the deselect region setting is also saved. However, the pattern cannot be saved if the deselect region setting is applied to all thread colors.
- The parts with the deselect region setting applied are merely not displayed; they are not deleted. The embroidery area required to embroider the pattern is the same as for the original pattern.



EDITING COLORS

Changing the Thread Color

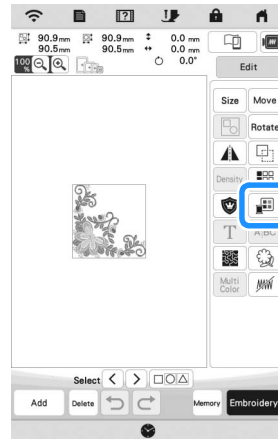

You can change the thread color by moving the color to be changed to the top of the embroidering order and selecting a new color from the thread colors in the machine.

- 1 Touch  , and then touch  .



→ The thread color palette appears.

- 2 Touch the color of the part to be changed.

- * Touch  or  to display the thread color that is not on the screen.
- The selected thread color image appears.

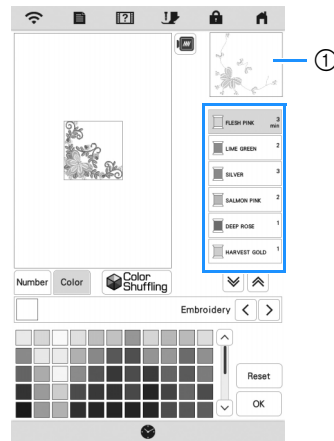

① Selected thread color image

 **Memo**

- When you directly touch a part of the pattern whose color is to be changed, the part can be selected and displayed.

3 Select a new color from the thread color palette, and

then touch **OK**.

* To return to the original color, touch **Reset**. If multiple colors have been changed, this command will return all colors to their original colors.

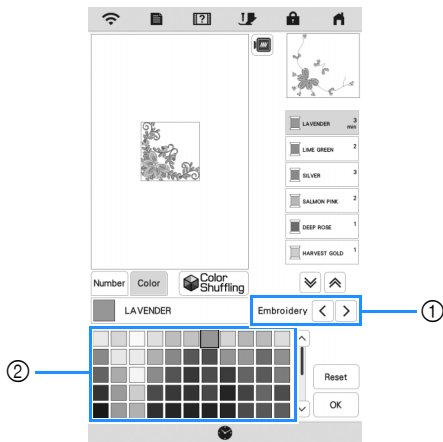

- ① Thread brand for colors
 - ② Thread color palette
- The display shows the changed colors.

Memo

- Touch **Number** to specify a thread color by entering its number. If you enter the wrong number, touch **C**, and then enter the correct number. After entering the number, touch **OK**.



Finding New Color Schemes with the Color Shuffling Function

With the color shuffling function, the machine suggests new color schemes for the embroidery pattern that you have selected. After you select the desired effect ([Random], [Vivid], [Gradient] or [Soft]), sample color schemes for the selected effect are displayed.

1 Touch **Edit**, and then touch

2 Touch **Color Shuffling**.



Memo

- This function may not be available depending on the pattern you select (ex. a repeated pattern, licensed pattern).

3 Select the thread brand for colors and the number of colors you want to create the pattern with.

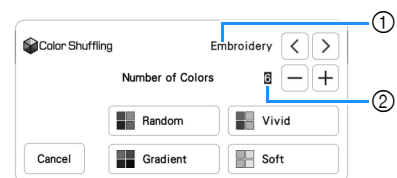

- ① Thread brand for colors
- ② Number of colors to be used

4 Select the desired effect.

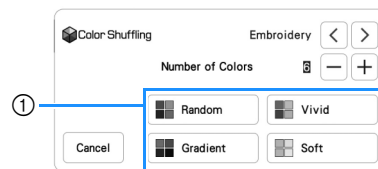

- ① Effects for schemes
- If you select [Random] or [Gradient], the color specifying screen will appear.
- If you select [Vivid] or [Soft], proceed to step **7**.

5 Touch **Auto** **Manual** to set **Manual** and specify the thread color to use in the effect.

* If you don't need to specify the thread color, just set to **Auto**.

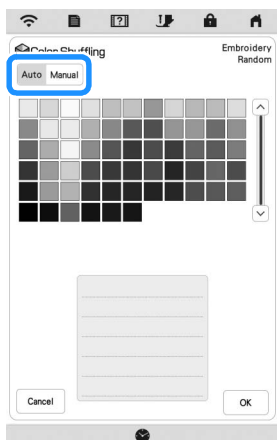

[Manual] setting for [Random]

You can select up to 6 colors to be used in the [Random] effect. The effect will be created using the selected colors.



- ① Select colors from the palette.
- ② Selected colors are listed.

[Manual] setting for [Gradient]

You can select one color to be used in the [Gradient] effect. The effect will be created with a color you select.

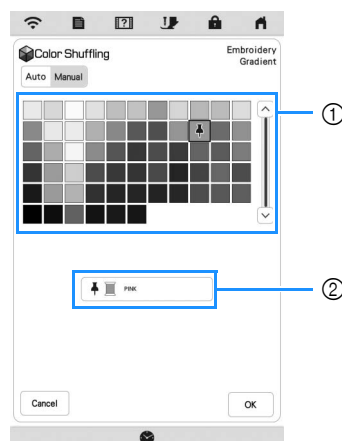

- ① Select a color from the palette.
- ② Selected color is displayed.

6 Touch **OK**.

7 Select the desired color scheme from samples.

* Touch **Refresh** to add the new schemes.

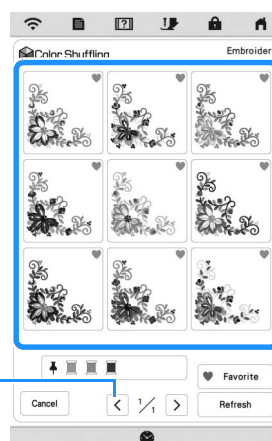

- ① Touch to review the previous schemes.

Memo

- To temporarily register your favorite schemes, touch (to release your favorite schemes, touch again). 9 color schemes can be added. Touch to check the registered favorite schemes. To cancel the registration, touch .

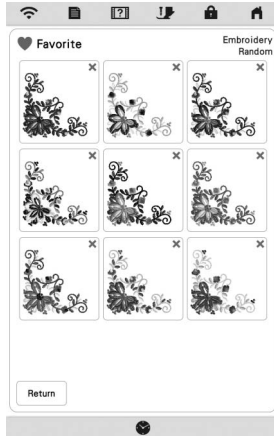

- Maximum 20 pages of schemes can be reviewed.

8 Select the displayed color scheme.

- * : Return to the previous screen.
- * or : Display the other color schemes.
- * : Select the displayed color scheme.



→ The thread color palette screen will appear.

Thread Color Sorting

This function allows you to embroider while replacing the thread spool a minimal number of times.

Before starting to embroider, touch in the embroidery screen to rearrange the embroidery order and sort it by thread colors.

1 Touch in the embroidery screen.

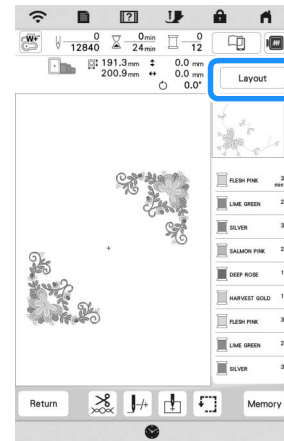

2 Touch .

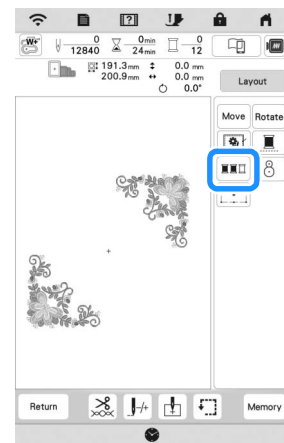

- * Touch again to check the sorted thread colors.

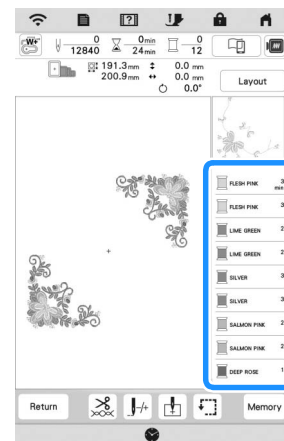

→ The embroidery color order is rearranged and sorted by thread colors.

- * Touch , then to cancel color sorting and embroider with the original embroidery color order.

Note

- This function does not work on overlapping patterns.

VIEWING THE EMBROIDERY SCREEN

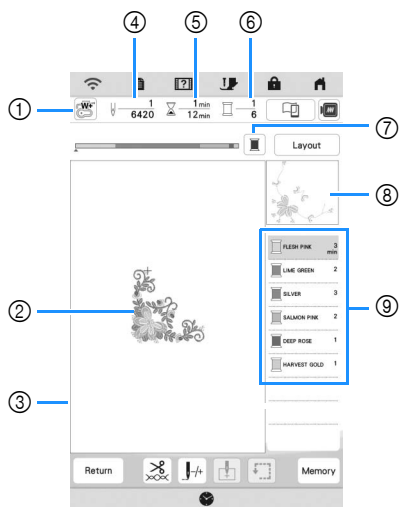

* This screen appears when embroidery starts.

- ① The presser foot symbol
Attach embroidery foot “W+” with LED pointer or embroidery foot “W” (sold separately) for all embroidery projects.
 - ② A preview of the pattern
 - ③ The boundary for embroidering with the selected frame in the settings screen
 - ④ Total number of stitches in the selected pattern and number of stitches that have already been embroidered
 - ⑤ The time necessary to embroider the pattern, and the time already spent embroidering the pattern (not including time for changing and automatically trimming the thread)
 - ⑥ The number of colors in the pattern, and the number of the color currently being embroidered
 - ⑦ Switch the progress bar (which shows the embroidering progress) between showing only one color or all colors. This key appears after starting embroidering or after touching the key.
 - ⑧ The part of the embroidery pattern that will be embroidered with the thread color at the top of the list
 - ⑨ The order for thread color changes and the embroidering time for each thread color
- * The displayed time is the approximate time that will be required. The actual embroidering time may be longer than the displayed time, depending on the embroidery frame that is used. In addition, the amount of time required to change thread colors is not included.

Key Functions

Using these keys, you can move or rotate pattern, etc.



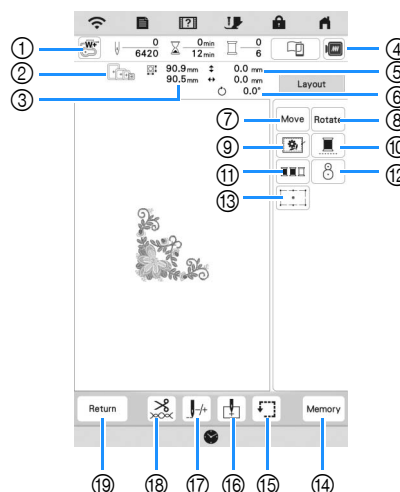











Touch to display the editing window.



Note

- Some operations or functions are not available for certain patterns. If the key display is grayed out, you cannot use that function or operation with the selected pattern.

No.	Display	Explanation	Page
	Name		
①		Turn on the light of the LED pointer.	130
	Needle point check key	Touch this key to check the needle drop point with the light of the LED pointer.	
②		Shows the embroidery frames that can be used for the selected pattern. Be sure to use the proper frame.	127
	Available frames		
③	90.9 mm 90.5 mm	Shows the size of the selected pattern.	—
	Pattern size		
④		Preview the embroidery image.	113
	Image key		
⑤	0.0 mm 0.0 mm	Shows the distance between the embroidering position and the center (when the embroidery pattern is moved).	—
	Distance		
⑥	0.0°	Shows the degree of rotation of the pattern.	—
	Degree		
⑦		Display the pattern moving window.	—
	Move key		
⑧		Display the pattern rotating window.	—
	Rotate key		
⑨		Add the basting stitch around the pattern. You can select the distance from the pattern to the basting stitching.	22, 143
	Basting key		

No.	Display	Explanation	Page
	Name		
⑩		Change the setting to embroider the pattern with a single color. Touch the key again to return to the original setting. Even if uninterrupted embroidering  has been set, the automatic thread cutting function and the thread trimming function can be used. The icons of the spool of thread are grayed out.	—
	Uninterrupted embroidery key		
⑪		Touch this key to rearrange the stitching sequence for combined patterns.	123
	Thread color sorting key		
⑫		Touch this key to align the embroidering position.	132
	Embroidery positioning key		
⑬		Switch on/off the 2-point embroidery positioning function with a LED pointer.	133
	2-point embroidery positioning function with a LED pointer on/off key		
⑭		Save the pattern to the machine's memory or USB media. The pattern can also be transferred to a computer via a wireless network connection.	153
	Memory key		
⑮		Check the position of the pattern. <ul style="list-style-type: none">  : Move the carriage to trace the embroidery area of the pattern. This allows you to check that there is enough space to embroider the pattern.  : Move the carriage to the selected position. 	132
	Trace key		
⑯		Specify the needle start position. <ul style="list-style-type: none">  : Set the needle start position to the lower-left corner of the pattern. This setting is useful when connecting patterns since it allows you to continue embroidering until the first stitch of the next pattern.  : Move the carriage to the selected position. 	151, 152
	Starting point key		
⑰		Move the needle forward or back in the pattern; useful if the thread breaks while embroidering or if you want to start again from the beginning.	141
	Forward/Back key		
⑱		Set automatic thread cutting, thread trimming or the thread tension. For embroidery, these functions are set automatically.	147-150
	Cut/Tension key		

No.	Display	Explanation	Page
	Name		
⑲		Return to the edit screen.	—
	Return key		



PREPARING THE FABRIC

⚠ CAUTION

- Use fabrics with a thickness of less than 2 mm (approx. 1/16 inch). Using fabrics thicker than 2 mm (approx. 1/16 inch) may cause the needle to break and cause injury.

📖 Memo

- When using layers with thicker batting etc., you can embroider more attractive finishes by adjusting the embroidery presser foot height in the embroidery settings screen.

Touch , and use  and  in the [Embroidery Foot Height] in the embroidery settings screen. Adjust the presser foot height for thick or puffy fabrics.



- To increase the space between the embroidery foot and the needle plate, set the [Embroidery Foot Height] to a larger number.
- In the case of thick terry cloth towels, we recommend that you place a piece of water soluble stabilizer on the top surface of the towel. This will help to reduce the nap of the toweling and result in more attractive embroidery.

Attaching Iron-on Stabilizers (Backing) to the Fabric

⚠ CAUTION

- Always use a stabilizer material for embroidery when embroidering on stretch fabrics, lightweight fabrics, fabrics with a coarse weave, or fabrics which cause pattern shrinkage. Otherwise, the needle may break and cause injury.

1 Iron the iron-on stabilizer material to the wrong side of the fabric.

- Use a piece of stabilizer which is larger than the embroidery frame being used.

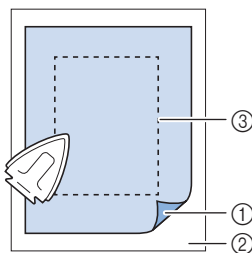

- ① Fusible side of stabilizer
- ② Fabric (wrong side)
- ③ Size of the embroidery frame

📖 Memo

- When embroidering small pieces of fabric that cannot be hooped in an embroidery frame, use stabilizer material as a base. After lightly ironing the fabric to the stabilizer material, hoop it in the embroidery frame. If stabilizer material cannot be ironed onto the fabric, attach it with a basting stitch. After completing the embroidery, remove the stabilizer material carefully.

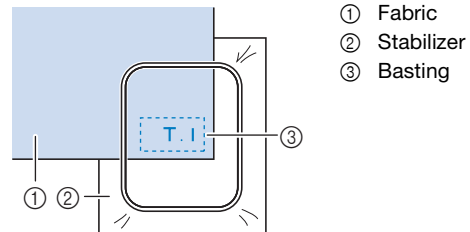

- When embroidering on thin fabrics such as organdy or lawn, or on napped fabrics such as towel or corduroy, use water soluble stabilizer (sold separately) for best results. The water soluble stabilizer material will dissolve completely in water, giving the project a more attractive finish.

Hooping the Fabric in the Embroidery Frame

Types of Embroidery Frames

Optional embroidery frames can be used. When choosing frames that do not appear on the screen, be sure to check the design size of the embroidery field of the optional frame. Check with your authorized Brother dealer for frame compatibility.

Select a frame that matches the pattern size. Available frame options are displayed on the LCD.

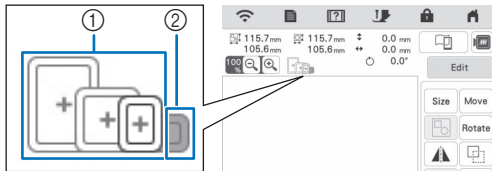

- ① Highlighted: Can be used
- ② Shaded: Cannot be used

Inserting the Fabric

Note

- If the fabric is not securely held in the embroidery frame, the pattern will embroider out poorly. Insert the fabric on a level surface, and gently stretch the fabric taut in the frame.
- Embroidery frames with factory-coded stickers can be used with the application (My Design Snap). (page 179)

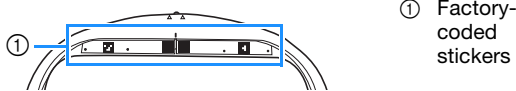

- ① Factory-coded stickers

1 Lift-up and loosen the frame adjustment screw and remove the inner frame.

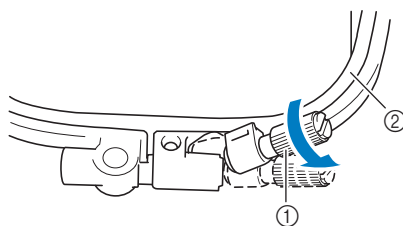

- ① Frame adjustment screw
- ② Inner frame

2 Lay the fabric right side up on top of the outer frame.

3 Insert the inner frame making sure to align the inner frame's \triangle with the outer frame's ∇ .

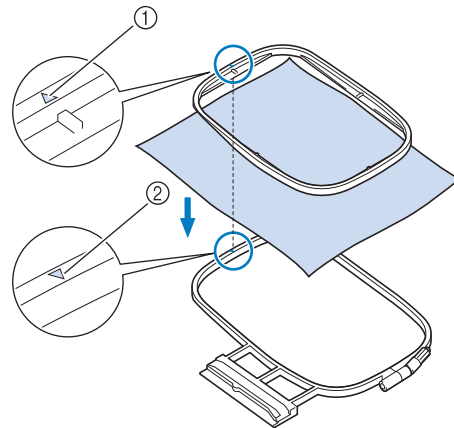

- ① Inner frame's \triangle
- ② Outer frame's ∇

4 Slightly tighten the frame adjustment screw.

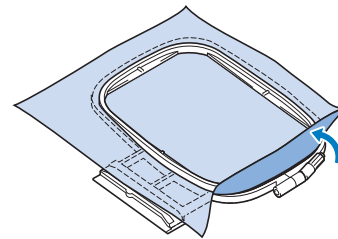

5 Gently smooth out the fabric. Make sure fabric is flat and without wrinkles.

- * After stretching the fabric, make sure the fabric is taut.

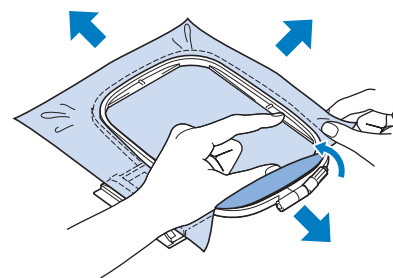

- * Make sure the inside and outside frames are even before you start embroidering.

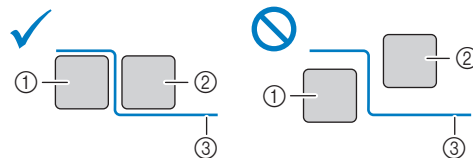

- ① Outer frame
- ② Inner frame
- ③ Fabric

- 6** Tighten the frame adjustment screw to keep the fabric from loosening while stitching.

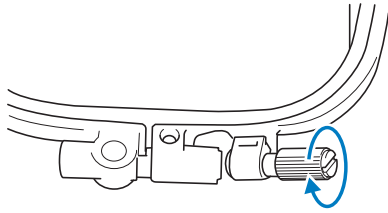

- 7** Return the frame adjustment screw to its initial position.

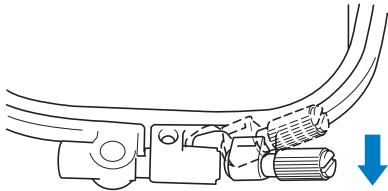

Memo

- You can use the disc-shaped screw driver, when you loosen or tighten the frame adjustment screw.

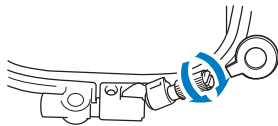

Using the Embroidery Sheet

When you want to embroider the pattern in a particular place, use the embroidery sheet with the frame.

- 1** With a chalk pencil, mark the area of the fabric you want to embroider.

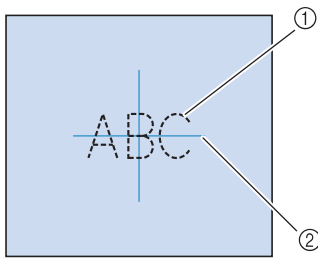

- ① Embroidery pattern
- ② Mark

- 2** Place the embroidery sheet on the inner frame. Align the guide lines on the embroidery sheet with the mark you made on the fabric.

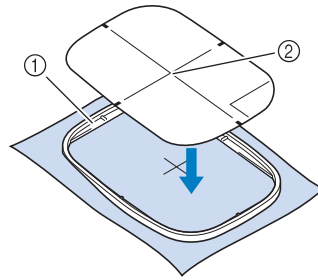

- ① Inner frame
- ② Guide line

- 3** Gently stretch the fabric so there are no folds or wrinkles, and press the inner frame into the outer frame.

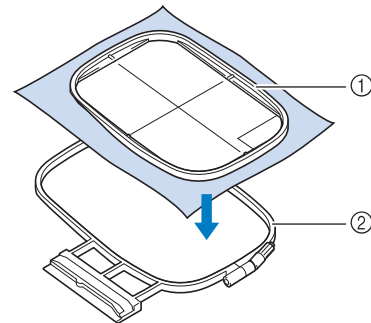

- ① Inner frame
- ② Outer frame

- 4** Remove the embroidery sheet.

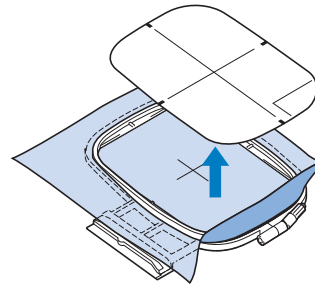

ATTACHING THE EMBROIDERY FRAME



Note

- Wind embroidery bobbin thread and insert the bobbin before attaching the embroidery frame. Check that there is enough thread in the bobbin.
- Make sure that the frame-securing lever is correctly lowered after the embroidery frame has been installed in the embroidery frame holder.

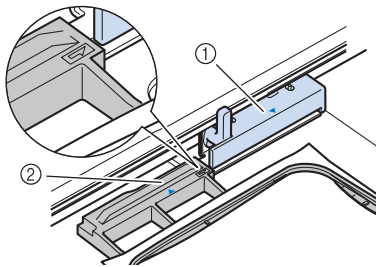
- 1 Press  (Presser foot lifter button) to raise the presser foot.
- 2 Align the embroidery frame guide with the right edge of the embroidery frame holder.



- ① Embroidery frame holder
② Embroidery frame guide

- 3 Slide the embroidery frame into the holder, making sure to align the embroidery frame's  with the holder's .

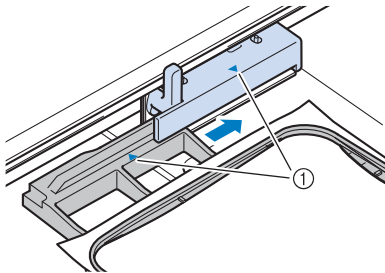

- ① Arrow mark

- 4 Lower the frame-securing lever to be level with the frame to secure the embroidery frame in the embroidery frame holder.

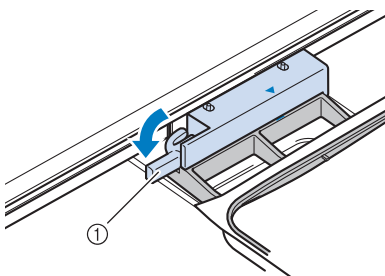

- ① Frame-securing lever

Removing the Embroidery Frame

- 1 Press  (Presser foot lifter button) to raise the presser foot.
- 2 Raise the frame-securing lever.

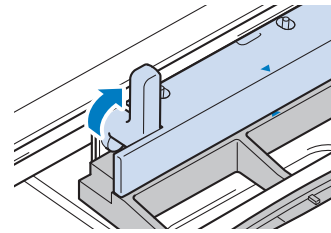

- 3 Pull the embroidery frame toward you.

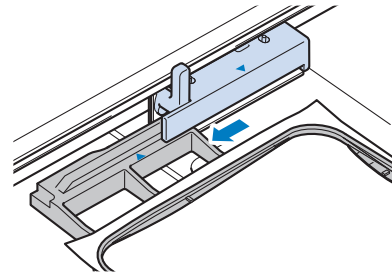

CONFIRMING THE PATTERN POSITION

The pattern is normally positioned in the center of the embroidery frame. If the pattern needs to be repositioned for better placement on the garment, you can check the layout before starting embroidery.



Checking the Needle Drop Point with the Embroidery Foot “W+” with LED Pointer

1 Touch  in the embroidery screen.

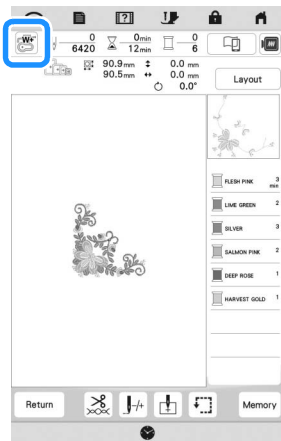
→ The LED pointer indicates the needle drop point.



Memo

- When the LED pointer turns on, the presser foot height is automatically adjusted according to the fabric thickness.
-  appears when the embroidery foot “W+” with LED pointer is attached to the machine.
- If  is not displayed, you cannot use the LED pointer.
- The LED pointer turns off automatically by lowering the presser foot or returning to the previous page.

Note

- With spongy fabric, the position may not be accurate due to the various depths of the fabric.
- With fabric that has a very uneven surface such as quilting, the fabric thickness may not be correctly measured. In this case, the pointer indication should be used only as a reference.

■ Adjusting the LED Pointer

Adjust the LED pointer if it indicates a point different than the actual needle drop point. Before adjusting the LED pointer, mark the actual needle drop point on the fabric to be embroidered, and attach the embroidery frame.

1 Touch .

→ The settings screen appears.

2 Touch .

→ The embroidery settings screen appears.

3 Display [Embroidery Foot with LED Pointer Adjustment] in the embroidery setting screen.



Note

- As a default,  appears gray. After the embroidery foot “W+” with LED pointer is attached to the machine, the key becomes available and settings can be specified.

4 Touch .



→ The Embroidery Foot “W+” with LED Pointer Adjustment screen appears.



① LED pointer adjustment

Note

- The specified setting is saved in the machine's memory. This is useful for positioning during continuous embroidering.
- For normal use, return the setting to [00].

5 Use  or  to adjust the LED pointer so that it indicates the actual needle drop point.



Memo

- In order to more accurately check the needle drop point, turn the handwheel toward you (counterclockwise) to lower the needle.

6 Touch  to return to the original screen.

■ Adjusting the Brightness of the LED Pointer

1 Follow the steps from **1** to **3** of “Adjusting the LED Pointer” on page 130 to display the embroidery foot with LED pointer adjustment screen.

2 Use  or  to adjust the brightness of the LED pointer.

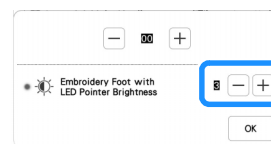

3 Touch  to return to the original screen.

Displaying a Background Image

Using a special application downloaded to a smartphone or tablet, you can transfer a photo of the hooped fabric to be embroidered to the machine to be used as a background image.

The embroidery frame is displayed in the application. You can see how the pattern will be arranged on the actual fabric.

For details, refer to "MY DESIGN SNAP APP" on page 179.

Note

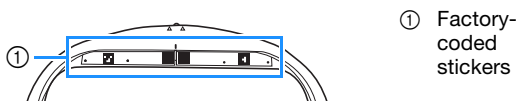

- The wireless network settings must first be specified on the machine. Refer to "WIRELESS NETWORK CONNECTION FUNCTIONS" on page 27.
- Embroidery frames with factory-coded stickers can be used with the application (My Design Snap).



① Factory-coded stickers

Displaying the Background Image on the Screen of the Machine

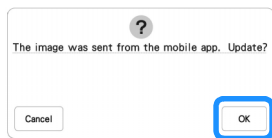

- 1 Select the pattern. (page 105)
- 2 Photograph the fabric in the frame with the easy mode of the application, and then transfer it to the machine.
For a detailed procedure, refer to the application.

- 3 Touch .
* Attach the frame used in the image before touching .



→ The transferred background image appears on the screen of the machine.

Memo



- To hide the background image, touch .
- Touch  to display the background image again.
- The transferred background image includes the embroidery frame display.

Calibrating the Position of the Background Image

By calibrating the position of the background image transferred to the machine, the pattern can be positioned more accurately.

- 1 Select a pattern. (page 105)
- 2 Set the application to advanced mode, attach the embroidery positioning sticker to the fabric in the hoop, take the photo of the background, and with the advanced mode of the application, transfer it to the machine.

For a detailed procedure, refer to the application.

- 3 Touch .
* Attach the frame used in the image before touching .



→ The carriage will move, and the LED pointer will turn on.

- 4 Use  to align the LED pointer with the center of the larger circle in the embroidery positioning sticker.

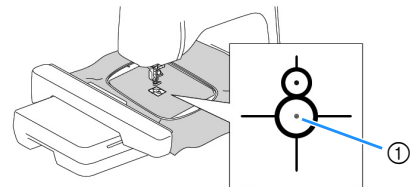

① Center of the larger circle in the embroidery positioning sticker

Memo

- The position can also be calibrated by lowering the needle with the handwheel. This method enables more accurate positioning. Slowly turn the handwheel toward you (counterclockwise) to check the needle drop point. Then, turn the handwheel away from you (clockwise) until the mark on the handwheel is at the top. The carriage cannot move if the mark on the handwheel is not at the top.

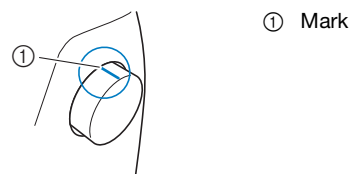

① Mark

- 5 Touch .
→ The position of the background image is calibrated.

■ **Aligning the Embroidering Position**

1 Calibrate the position of the background image. (page 131)

2 Touch .

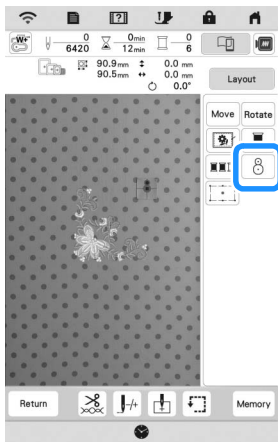

 **Memo**

- The orientation of the pattern will change depending on the orientation of the embroidery positioning sticker.

3 When the following message appears, touch .

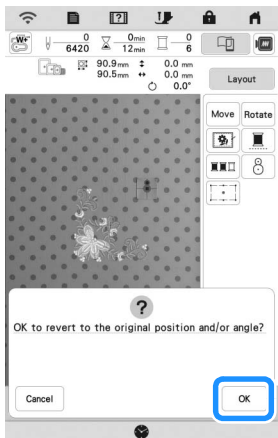

4 Select the position to be set as the reference point.



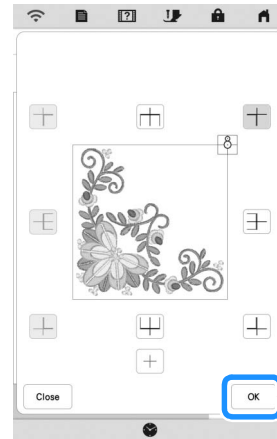

5 Touch .

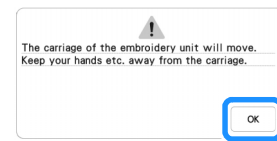

→ When the following message appears, touch .



6 Remove the embroidery positioning sticker, and then start embroidering.

- * To remove the embroidery positioning sticker more easily, touch  so that the embroidery frame moves slightly forward and away from under the needle. After the embroidery positioning sticker is removed, touch .

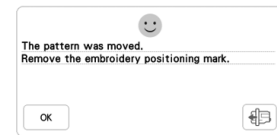

Checking the Pattern Position

The carriage moves and shows the pattern position. Watch the embroidery frame closely to make sure the pattern will be embroidered in the right place.

1 Touch .

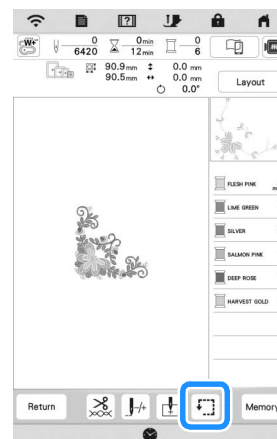

- 2 From , touch the key for the position that you want to check.

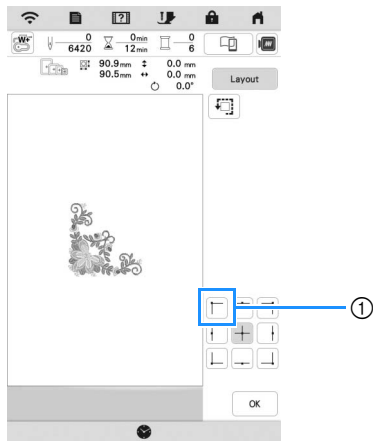

- ① Selected position
→ The carriage will move to the selected position on the pattern.

 **Memo**

- To see the entire embroidering area, touch . The carriage moves and shows the embroidery area.

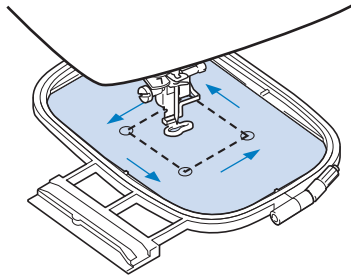

 **CAUTION**

- Do not lower the needle when the embroidery frame is moving. If the needle is down, it could break and result in injury.

- 3 Touch .

THE 2-POINT EMBROIDERY POSITIONING FUNCTION

By using the 2-point embroidery positioning function with a LED pointer, the embroidering position can easily be aligned. This is useful when embroidering in an area where it is necessary to align the pattern, as shown below.

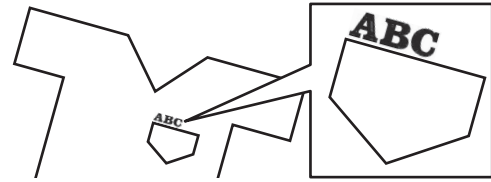

- 1 Use a chalk pencil to mark the desired embroidering position.

The line drawn for the reference direction should be longer.

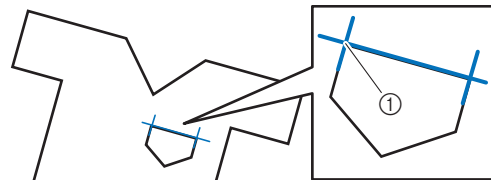

- ① Chalk pencil mark

 **Memo**

- If the desired position of the pattern can be clearly established, such as when embroidering along a pocket, it is not necessary to mark the position with a chalk pencil.

- 2 Hoop the fabric in the embroidery frame.

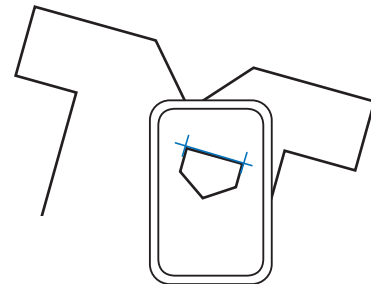

 **Note**

- When hooping the fabric in the embroidery frame, make sure that the embroidery pattern will fit within the embroidering area of the frame being used.

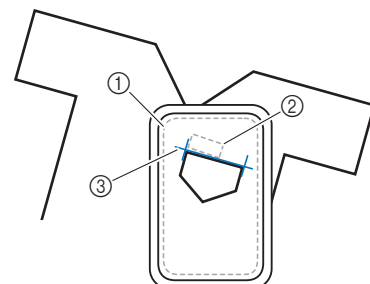

- ① Embroidering area
② Embroidery pattern size
③ Chalk pencil mark

- 3 Select the pattern.
- 4 Touch **Embroidery** to display the embroidery screen.
- 5 Touch **Layout** and then touch .

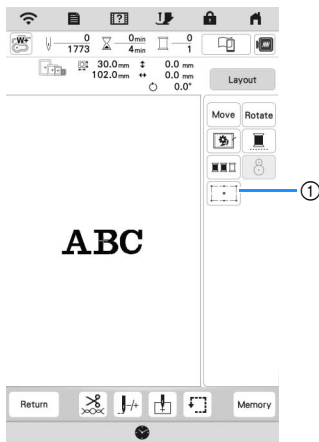

1 Switch on/off the 2-point embroidery positioning function with a LED pointer.

Memo

- The LED pointer lights up to indicate the needle drop point.
- When the LED pointer is turned on, the embroidery foot height is automatically adjusted according to the fabric thickness.
- If the surface of the fabric is too uneven or rough, check and adjust the alignment of the light of the LED pointer and the needle drop point before starting to embroider.

- 6 If a message appears, indicating that the move and rotate settings will return to the original ones, touch **OK**.

- 7 From the reference points shown in the screen, select the point to be used for aligning the pattern.
For this example, select the point in the lower-left corner of the pattern.

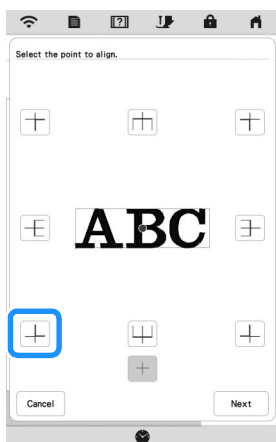

- 8 Touch **Next**.
- 9 Select the direction (from the reference point) to be used as a reference for aligning the pattern.
For this example, select the arrow pointing to the right as the reference direction.

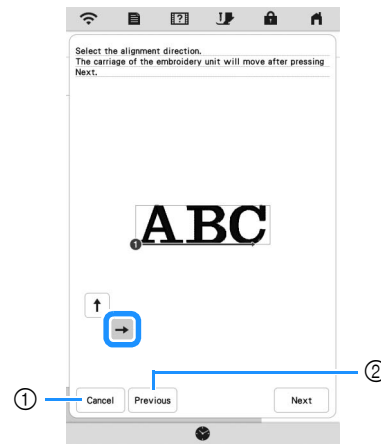

1 Cancel the pattern alignment settings.
2 Return to the previous screen.

- 10 Touch **Next**.

- 11 Touch the positioning keys to move the embroidery frame until the position of the LED pointer and the center of the first mark are aligned.

To change the speed that the frame moves, use the frame movement speed keys. If it is difficult to make a precision alignment, touch a frame movement speed key for a slower speed.

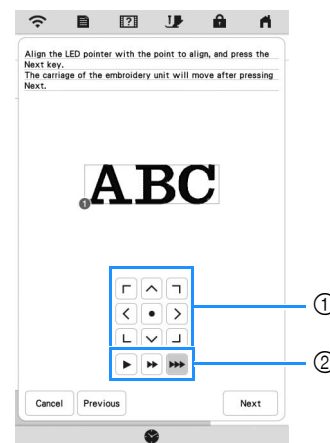

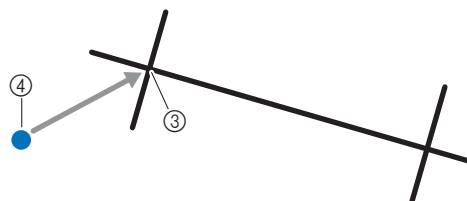

1 Positioning keys
2 Frame movement speed keys



3 Center of the first mark
4 Light of the LED pointer

Note

- If  is displayed to the left of the positioning keys, the LED pointer has shifted from its initial position. Touch  to adjust the position.

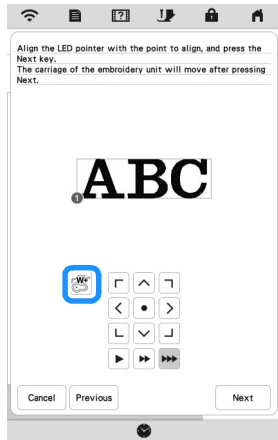

12 Touch  .

13 Touch the positioning keys to move the embroidery frame until the position of the LED pointer and the center of the second mark are aligned.

To change the speed that the frame moves, use the frame movement speed keys. If it is difficult to make a precision alignment, touch a frame movement speed key for a slower speed.

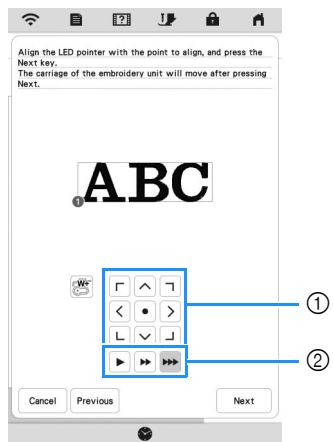

- ① Positioning keys
- ② Frame movement speed keys

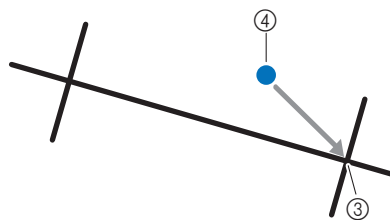

- ③ Center of the second mark
- ④ Light of the LED pointer

Note

- Set the position of the LED pointer to a position that is not too close to the first reference point. If it is too close, a message will appear, prompting you to reposition it.
- In order to increase the accuracy of the pattern alignment, align the position of the LED pointer above the second mark (③) and as far away from the center mark as possible.

14 Touch  .

→ The pattern is repositioned.

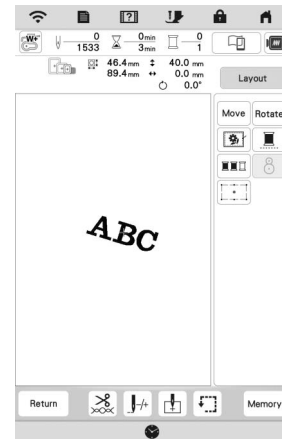

15 Press the “Start/Stop” button to start embroidering.

Another example

By specifying an alignment point and direction, embroidery patterns can be positioned and aligned for various purposes.

In this example, a pattern is aligned at the left center of the towel.

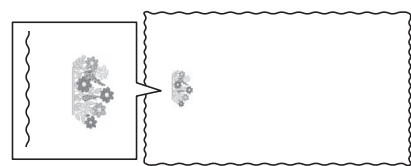

1 Use a chalk pencil to mark the desired embroidering position.

The line drawn for the reference direction should be longer.

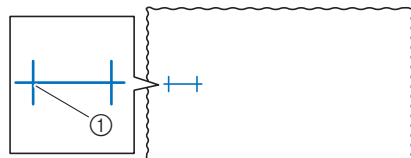

- ① Chalk pencil mark

2 Hoop the fabric in the embroidery frame.

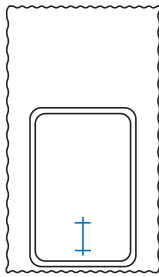

3 Select the pattern.

4 Touch **Embroidery** to display the embroidery screen.

5 Touch **Layout** and then touch

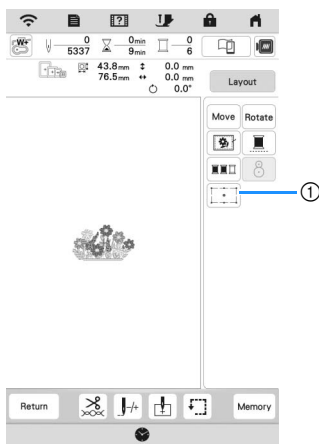

1 Switch on/off the 2-point embroidery positioning function with a LED pointer.

6 If a message appears, indicating that the move and rotate settings will return to the original ones, touch **OK**.



7 From the reference points shown in the screen, select the point to be used for aligning the pattern.

For this example, select the point in the lower-center of the pattern.

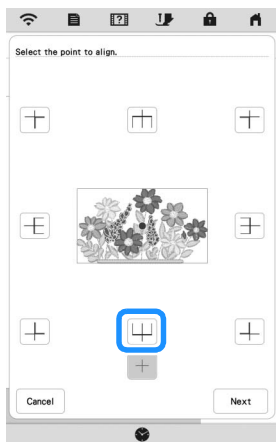

8 Touch **Next**.

9 Select the direction (from the reference point) to be used as a reference for aligning the pattern.

For this example, select the arrow pointing upward as the reference direction.

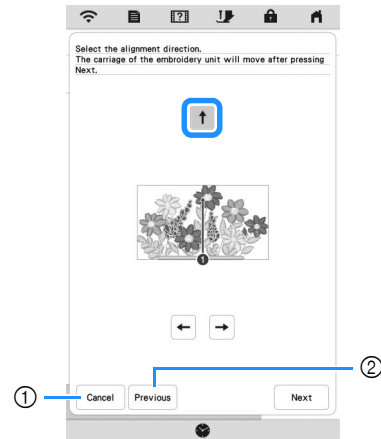

1 Cancel the pattern alignment settings.
2 Return to the previous screen.

10 Touch **Next**.

11 Touch the positioning keys to move the embroidery frame until the position of the LED pointer and the center of the first mark are aligned.

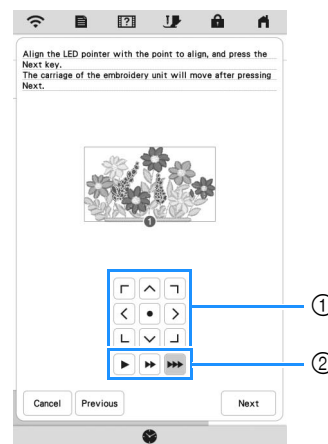

1 Positioning keys
2 Frame movement speed keys

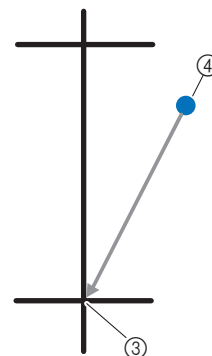

3 Center of the first mark
4 Light of the LED pointer

12 Touch **Next**.

13 Touch the positioning keys to move the embroidery frame until the position of the LED pointer and the center of the second mark are aligned.

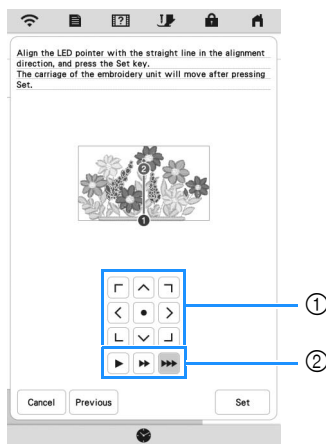

- ① Positioning keys
- ② Frame movement speed keys

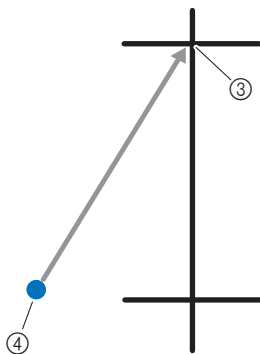

- ③ Center of the second mark
- ④ Light of the LED pointer

14 Touch **Set**.

→ The pattern is repositioned.

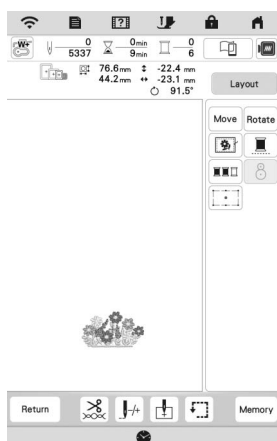

15 Press the "Start/Stop" button to start embroidering.

EMBROIDERING A PATTERN

Embroidering Attractive Finishes

Many factors are involved in achieving a beautiful embroidery result. Using the appropriate stabilizer (page 126) and hooping the fabric in the frame (page 127) are two important factors mentioned earlier. Another important point is the appropriateness of the needle and thread being used. See the explanation of threads below. Included with this machine are two bobbin cases. Follow the explanation below.

Thread	Upper thread	Use embroidery thread intended for use with this machine.
	Bobbin thread	Use embroidery bobbin thread intended for use with this machine.

Memo

- If you use threads other than those listed above, the embroidery may not embroider out correctly.

Bobbin case (recommended for sewing and for embroidering with included 60 weight bobbin thread)

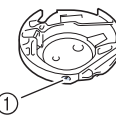

- ① Standard bobbin case (green marking on the screw)

Standard bobbin case originally installed in the machine has a green marking on the screw. We recommend using the included embroidery bobbin thread with this bobbin case. Do not adjust the tension screw on this bobbin case with the green marked screw.

Bobbin case (for prewound or other embroidery bobbin threads)

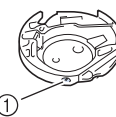

- ① Bobbin case (no color on the screw)

The bobbin case with no color on the screw is set with tighter tension for embroidery with different weights of bobbin threads and a variety of embroidery techniques. This bobbin case is identified with a dark colored mark on the inside of the bobbin cavity. The tension screw on this case can be adjusted if necessary. For details, refer to "Adjusting the Alternate Bobbin Case (with No Color on the Screw)" on page 148.

⚠ CAUTION

- When embroidering on large items (especially jackets or quilts), do not let the fabric hang off of the table. Otherwise, the embroidery unit cannot move freely and the embroidery frame may strike the needle, causing the needle to break and possibly causing injury.

■ Embroidery Needle Plate Cover

Under some conditions, based on the type of fabric, stabilizer, or thread being used, there may be some looping in the upper thread. In this case, attach the included embroidery needle plate cover to the needle plate. Attach the cover by inserting the two projections on the underside of the cover into the notches on the needle plate as shown below.

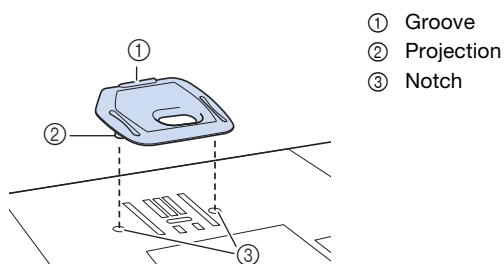

To remove the embroidery needle plate cover, place your fingernail in the groove and lift the plate out.

⚠ CAUTION

- Push the embroidery needle plate cover as far as possible to attach it. If the embroidery needle plate cover is not securely attached, it may cause the needle to break and cause injury.

Embroidering Patterns

- Prepare embroidery threads of the colors shown on the screen.

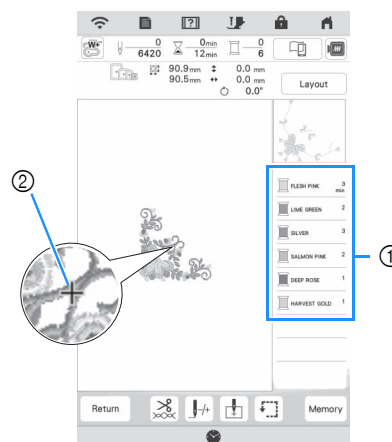

- Embroidery color order
- Cursor

📖 Memo

- The [+] cursor moves over the pattern, showing which part of the pattern is being embroidered.

- Using the automatic needle threader, thread the machine for the first color. (page 36)

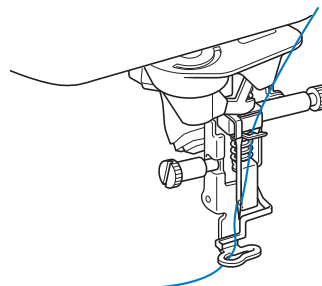

- Lower the presser foot, then press the "Start/Stop" button to start embroidering.

→ When the first color is completely embroidered, the machine will automatically trim the threads and stop. The embroidery foot will then automatically be raised. On the embroidery color order display, the next color will move to the top.

Memo

- If you want to get more attractive finishes, try the procedures below;
 - After 5-6 stitches, press the “Start/Stop” button again to stop the machine.
 - Trim the excess thread at the beginning of the pattern. If the excess thread tail is under the embroidery foot, raise the embroidery foot, then trim the excess thread.

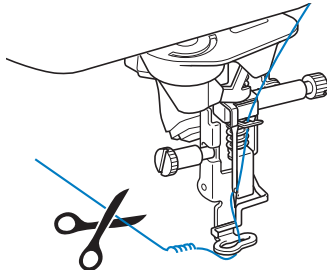

- If there is thread left over from the beginning of embroidering, it may be embroidered over as you continue embroidering the pattern, making it very difficult to deal with the thread after the pattern is finished. Trim the threads at the beginning of each thread change.

4 Remove the upper thread for the first color from the machine. Thread the machine with the next color.

5 Repeat the same steps for embroidering the remaining colors.

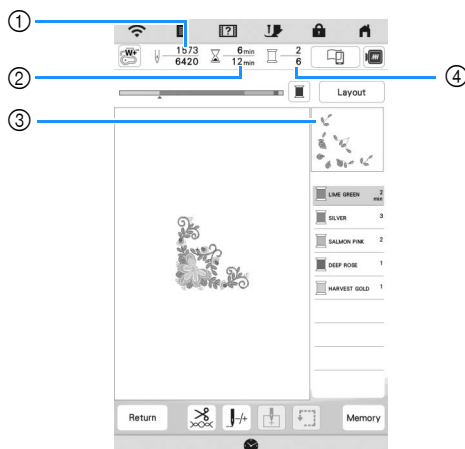

- ① Current stitch numbers/Total stitch numbers
- ② Current time/Total time
- ③ Part of pattern to be embroidered next
- ④ Embroidered colors/Total colors

→ When the last color is embroidered, [Finished embroidering] will appear on the display. Touch

, and the display will return to the original screen.

Memo

- The thread trimming function is originally set to trim excess thread jumps (threads linking parts of the pattern, etc.). Depending on the type of thread and fabric that are used, an end of upper thread may remain on the surface of the fabric at the beginning of the stitching. After embroidering is finished, cut off this excess thread.

If the setting has been turned off, trim the excess thread jumps using scissors after the pattern is finished. Refer to page 150 for information on the thread trimming function.

Using Appliqués

When the color embroidering order display shows

[] (APPLIQUE MATERIAL),

[] (APPLIQUE POSITION) or

[] (APPLIQUE)], follow the procedure below.

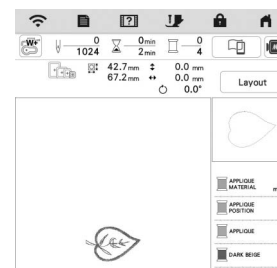

Required materials

- Fabric for the appliqué piece
- Fabric for the appliqué base
- Stabilizer material
- Fabric glue or temporary spray adhesive
- Embroidery thread

Note

- Refer to “Embroidery Design Guide” to review the recommended method for built-in appliqué patterns. Please visit <https://s.brother/cmekb/>. Some appliqué patterns differ from the procedure described in this manual.
- The correct names and numbers of the thread colors to be used will not appear. Use the thread colors depending on those in the appliqué pattern.

1. Creating an Appliqué Piece

- 1** Attach stabilizer material to the wrong side of the fabric for the appliqué piece.
- 2** Sew the cutting line of the appliqué piece. Remove the fabric for the appliqué piece from the embroidery frame, and then carefully cut along the sewn cutting line.



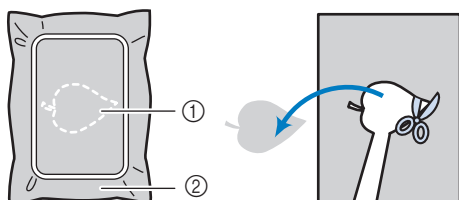

- ① Outline of appliqué
- ② Fabric for appliqué piece

Note

- If the appliqué piece is cut out along the inside of the cutting line, it may not be correctly attached to the fabric. Therefore, carefully cut out the appliqué piece along the cutting line.
- After cutting out the appliqué piece, carefully remove the thread.

2. Sewing the Appliqué Position on the Base Fabric

1 Attach stabilizer material to the wrong side of the fabric for the appliqué base.

2 Sew the appliqué position.

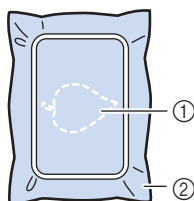

- ① Position of appliqué
- ② Base fabric

3 Remove the embroidery frame from the embroidery unit.

Note

- Do not remove the base fabric from the embroidery frame until all embroidering is finished.

3. Affixing the Appliqué Piece to the Base Fabric

1 Lightly apply fabric glue or temporary spray adhesive to the back of the appliqué piece, and then attach it to the base fabric within the outline of the position sewn in step **2** of "2. Sewing the Appliqué Position on the Base Fabric".

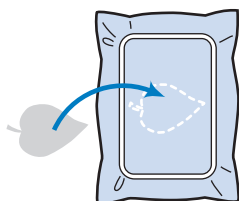

Note

- If the appliqué piece cannot be attached to the base fabric with fabric glue or temporary spray adhesive, securely baste it in place with basting stitches.
- If thin fabric is used for the appliqué piece, reinforce and secure it in place with an iron-on adhesive sheet. An iron can be used to attach the appliqué piece to the appliqué location.

2 After the appliqué piece is attached, attach the embroidery frame to the machine. Thread the machine with the embroidery thread, lower the presser foot lever, and then press the "Start/Stop" button to embroider the appliqué.

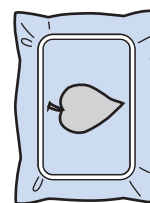

4. Embroidering the Remainder of the Pattern

1 Change the embroidery thread according to the embroidery color order display, and then finish embroidering the remainder of the pattern.

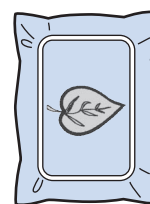

Memo

- Since glue may become attached to the presser foot, needle or needle plate, clean off any glue after finishing embroidering the appliqué pattern.
- For best results, trim all excess threads each time the thread color is changed.

ADJUSTMENTS DURING THE EMBROIDERY PROCESS

If the Thread Breaks or the Bobbin Runs out of Thread During Embroidering

1 Redo the upper threading or replace the bobbin.

If the upper thread breaks, stop the machine, trim the bobbin thread, and then rethread the machine.

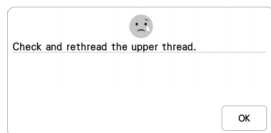

If the bobbin thread is almost empty or broken, touch  of the displayed message, remove the embroidery frame, and then replace the bobbin.

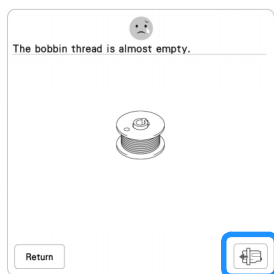

Note

- If [Upper and Bobbin Thread Sensor] in the settings screen of the machine is set to [OFF], the message shown above does not appear.



2 Touch .

3 Touch , , or to move the needle back the correct number of stitches before the area where the thread broke, and then touch .

- Touch  to restart from the beginning.

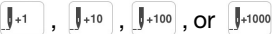

Memo

- If you cannot move back to the spot where the thread broke, touch  or  to select the color and move to the beginning position of that color, then use  to move ahead to slightly before where the thread broke.

4 Lower the presser foot and press the "Start/Stop" button to continue embroidering.

Resuming Embroidery after Turning off the Power

The current color and stitch number are saved when embroidery is stopped. The next time the machine is turned on, you have the option to continue or delete the pattern.

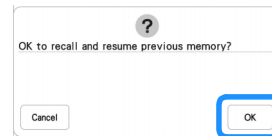

Chapter 5 ADVANCED EMBROIDERY

VARIOUS EMBROIDERING FUNCTIONS



Basting Embroidery

Before embroidering, basting stitches can be sewn along the outline of the pattern. This is useful for embroidering fabric that cannot have stabilizer material affixed with an iron or adhesive. Basting stitches can be used to attach material that cannot be hooped to stabilizer, making it possible to be embroidered.

Note

- It is recommended to finish combining and editing the pattern before selecting the basting setting. If the pattern is edited after selecting the basting setting, the basting and pattern may become misaligned, and the basting under the pattern may be difficult to remove after embroidering is complete.

1 Touch .



2 Use  and  to specify the distance from the pattern to the basting stitching.



Memo

- The higher the setting, the farther the basting is from the pattern.
- The setting remains selected even if the machine is turned off.

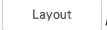
3 Touch  to return to the embroidering screen.

4 Touch , and then touch  to select the basting setting.

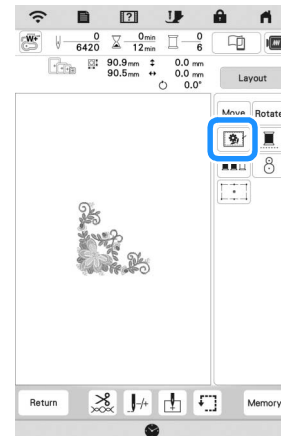

Note

- When  is touched, the pattern is moved to the center. After selecting the basting setting, move the pattern to the desired position.

→ Basting is added to the beginning of the embroidering order.

5 Press the "Start/Stop" button to start embroidering.

6 When embroidering is finished, remove the basting stitching.

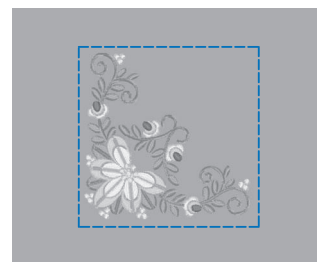

Creating an Appliqué Piece

Creating an appliqué piece is convenient for fabrics that cannot be embroidered or when you wish to attach an appliqué to a garment.

■ Creating an Appliqué Piece

The following pattern will be used to create an appliqué piece.



💡 Note

- Felt or denim fabrics are recommended to make the appliqué piece. Depending on the pattern and fabric used, lighter weight fabrics may cause the stitching to appear smaller.
- For best results, be sure to use stabilizer material for embroidering.
- When making appliqué pieces, do not use the optional border embroidery frame. Depending on the pattern density and fabric used, shrinkage of the stitching may occur.

1 Select the pattern, and edit it if necessary.

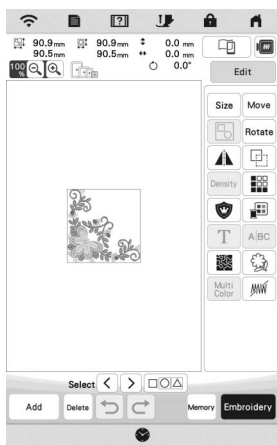

💡 Note

- Finish combining and editing the pattern before selecting the appliqué setting. If the pattern is edited after selecting the appliqué setting, the appliqué stitching and pattern may become misaligned.
- Since an outline is added, the pattern for an appliqué piece (when the appliqué setting is selected) will be larger than the original pattern. First, adjust the size and position of the pattern as shown below.

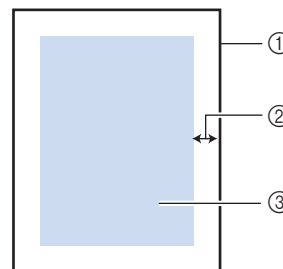

- ① Embroidering area
- ② About 1 cm (approx. 1/2 inch)
- ③ Pattern size

2 Touch **Edit** and then, touch .

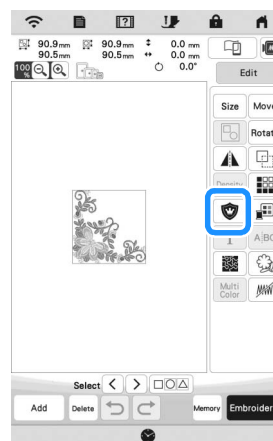

3 Specify the distance between the pattern and the appliqué outline, and then touch **OK**.



→ The pattern and appliqué outline are grouped.

4 Touch Embroidery

→ The steps for creating the appliqué piece are added to the embroidering order.

Memo

- Three steps are added to the embroidering order: appliqué cutting line, position of pattern placement on the stabilizer material, and appliqué stitching.

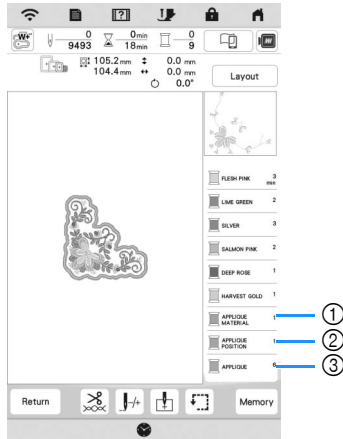

- ① Cutting line for appliqué
- ② Position of pattern placement on stabilizer material
- ③ Appliqué stitching

- When setting the [Thread color] to [#123] (thread number) in the settings screen, the following screen is displayed.

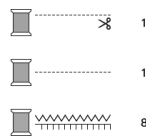

Note

- An appliqué piece cannot be created if the pattern is too large or too complicated or a combined pattern is separated. Even if the selected pattern fits within the embroidering area, the entire appliqué pattern may exceed the embroidering area when the outline is added. If an error message appears, select a different pattern or edit it.

5 Fuse or stick a piece of stabilizer to the back of the felt or denim fabric to be used as the appliqué piece.

6 Hoop the fabric for the appliqué piece in the embroidery frame, attach the embroidery frame to the machine, and then start embroidering.

7 After the pattern is embroidered, thread the machine with the thread for the cutting line, and then sew the cutting line (APPLIQUE MATERIAL).

① Cutting line for appliqué

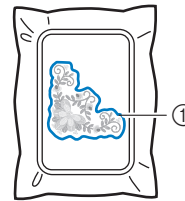

Memo

- We recommend using thread for the cutting line that is closest to the color of the fabric.

8 Remove the fabric for the appliqué piece from the embroidery frame, and then carefully cut along the stitching. After cutting, carefully remove all of the cutting line thread.

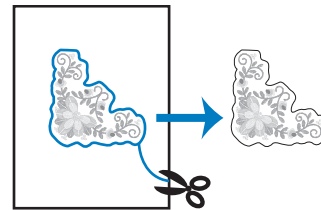

Note

- Depending on the pattern density and fabric used, there may be shrinking of the pattern, or the appliqué may be misaligned with the placement line. We recommend cutting slightly outside of the cutting line.
- When using patterns that are vertically and horizontally symmetrical, use a chalk pencil to indicate the pattern orientation before cutting it out.
- Carefully cut out the pattern on the outline you just sewed. Do not cut inside the cutting line, otherwise the appliqué fabric will not be caught by the appliqué stitch.

- 9** Use two layers of adhesive water soluble stabilizer material with their sticky sides together, and then hoop them in the embroidery frame.

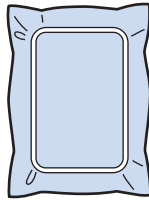

Note

- If water soluble stabilizer is used, it is not necessary to remove the stabilizer material after sewing the appliqué outline. To reduce shrinkage of the pattern, we recommend using water soluble stabilizer.
- Put together two layers of water soluble stabilizer, otherwise the stabilizer material may tear during embroidering.

- 10** Thread the machine with the thread for the outline, and then sew the placement line for the appliqué position (APPLIQUE POSITION).

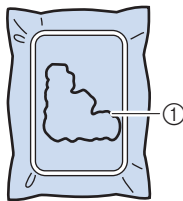

① Pattern placement line

- 11** Lightly apply glue or spray adhesive, and paste the appliqué piece so that it aligns with the placement line.

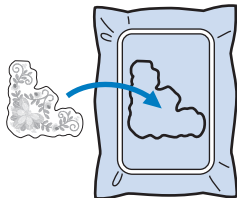

Note

- Before pasting the appliqué piece down, make sure the appliqué piece is positioned correctly within the placement line.

- 12** With the machine threaded using the thread for the outline from step 10, embroider the outline (APPLIQUE).

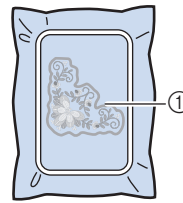

① Outline of appliqué piece

Memo

- The outline is sewn using satin stitching.
- Since glue may become attached to the presser foot, needle or needle plate, clean off any glue after finishing embroidering the appliqué pattern.

- 13** After embroidering is finished, remove the stabilizer material from the embroidery frame.

- 14** Use scissors to cut the excess water soluble stabilizer from outside the appliqué outline.

- 15** Soak the appliqué piece in water to dissolve the water soluble stabilizer.

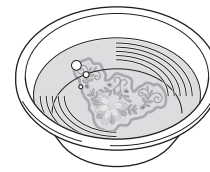

- 16** Dry the appliqué piece, and then iron it if necessary.

Note

- Do not apply a strong force when ironing, otherwise the stitching may be damaged.

MAKING EMBROIDERY ADJUSTMENTS

Adjusting Thread Tension

When embroidering, the thread tension should be set so that the upper thread can slightly be seen on the wrong side of the fabric.

The following screen appears when you touch .

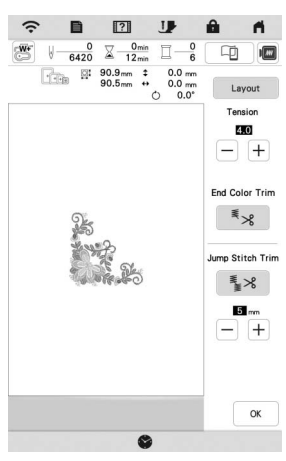
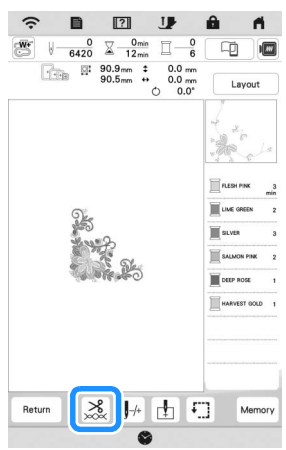

- Memo**
- If the thread tension is changed from the default setting, the new setting will remain after turning the machine off and on. This new setting will apply to any selected design.

- Correct Thread Tension**
- The pattern can be seen from the wrong side of the fabric. If the thread tension is not set correctly, the pattern will not finish well. The fabric may pucker or the thread may break.

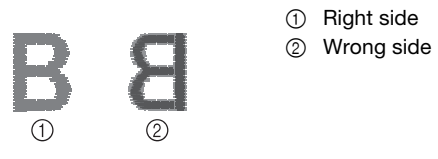

Follow the operations described below to adjust thread tension according to the situation.

- Note**
- If the thread tension setting is made extremely loose, the machine may stop during embroidering. This is not the sign of a malfunction. Increase the thread tension slightly, and start embroidering again.

- Memo**
- If the thread tension is changed from the default setting, the new setting will remain after turning the machine off and on. This new setting will apply to any selected design.

- Upper Thread Is Too Tight**
- The tension of the upper thread is too tight, resulting in the bobbin thread being visible from the right side of the fabric.

- Note**
- If the bobbin thread was incorrectly threaded, the upper thread may be too tight. In this case, refer to "Setting the Bobbin" on page 34 and rethread the bobbin thread.

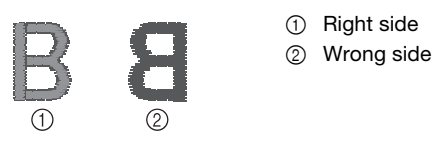

Touch  in **Tension** to weaken the upper thread tension. (The tension number will decrease.)

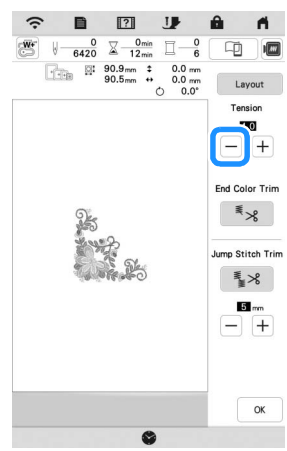

Upper Thread Is Too Loose

The tension of the upper thread is too loose, resulting in a loose upper thread, loose thread locks, or loops appearing on the right side of the fabric.

Note

- If the upper thread was incorrectly threaded, the upper thread may be too loose. In this case, refer to "Upper Threading" on page 36 and rethread the upper thread.

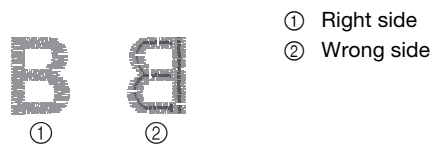

Touch **+** in **Tension** to tighten the upper thread tension. (The tension number will increase.)

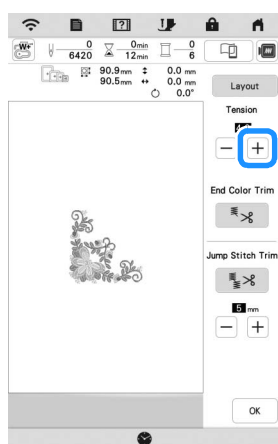

Adjusting Overall Upper Thread Tension

When embroidering, if the overall tension of the upper thread is too tight or too loose, adjust it from the setting screen. The selected setting will be applied to all patterns. If an individual embroidery pattern needs additional fine tuning, refer to "Adjusting Thread Tension" on page 147.

- Touch .
→ The settings screen appears.
- Touch .
→ The embroidery settings screen appears.
- Display [Embroidery Tension] in the embroidery settings screen.
- Use **+** **-** to adjust the upper thread tension.
 - * **+** : Tighten the upper thread tension.
 - * **-** : Loosen the upper thread tension.

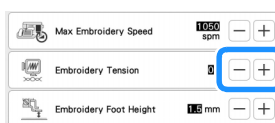

- Touch **OK** .

Adjusting the Alternate Bobbin Case (with No Color on the Screw)

When using the embroidery bobbin thread provided, please be sure to choose the green marked bobbin case when performing utility stitch sewing and embroidery functions. When in the embroidery function mode, the alternate bobbin case (with no color on the screw) should be selected when substitute embroidery bobbin threads (other than what is accompanied with your machine) are being used. The alternate bobbin case (with no color on the screw) can be easily adjusted when bobbin tension changes are required to accommodate different bobbin threads. Refer to "Embroidering Attractive Finishes" on page 137.

To adjust the bobbin tension for embroidery function, using the alternate bobbin case (with no color on the screw), turn the slotted screw (-) with a (small) screwdriver.

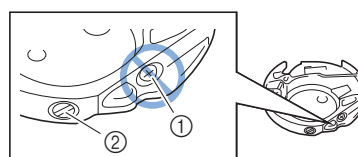

- Do not turn a phillips screw (+).
- Adjust with a screwdriver (small).

Correct Tension

Upper thread slightly appears on the wrong side of fabric.



Bobbin Thread Is Too Loose

Bobbin thread appears slightly on the right side of fabric.



If this occurs, turn the slotted screw (-) clockwise, being careful not to over-tighten the screw, approximately 30-45 degrees to increase bobbin tension.

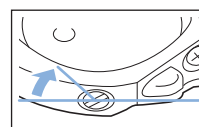

■ Bobbin Thread Is Too Tight

Upper thread on the right side of fabric seems to be lifting/looping and bobbin thread is not seen on the wrong side of fabric.



- ① Right side
- ② Wrong side

If this occurs, turn the slotted screw (-) counterclockwise, being careful not to over-loosen the screw, approximately 30-45 degrees to decrease bobbin tension.

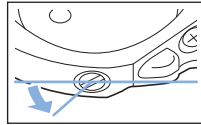



IMPORTANT

- **DO NOT** adjust the position of the phillips (+) screw on the alternate bobbin case as this may result in damage to the bobbin case, rendering it unusable.
- If the slotted screw (-) is difficult to turn, do not use force. Turning the screw too much or providing force in either (rotational) direction may cause damage to the bobbin case. Should damage occur, the bobbin case may not maintain proper tension.

Note

- When adjusting the alternate bobbin case, be sure to remove the bobbin from the alternate bobbin case.

Using the Automatic Thread Cutting Function (End Color Trim)

The automatic thread cutting function  will cut the thread at the end of embroidering each color. This function is initially turned ON. To turn this function OFF, touch  and then .

- * This setting returns to its default  when the machine is turned off.

1 Touch .

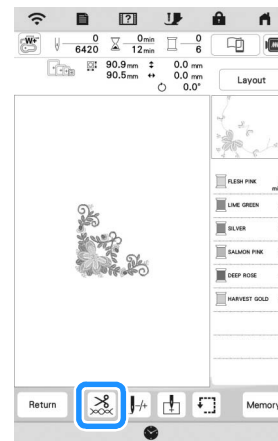

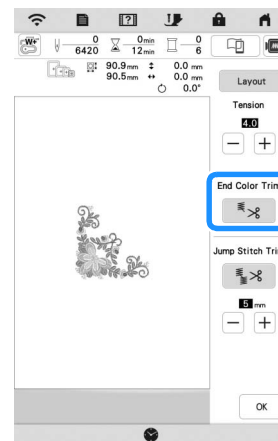

2 Touch  to turn off the automatic thread cutting function.



→ The key will display as . When one color thread is embroidered, the machine will stop without cutting the thread.

Using the Thread Trimming Function (Jump Stitch Trim)

The thread trimming function  will automatically trim any excess thread jumps within the color. This function is initially turned ON. To turn this function OFF, touch  key and then .

* Your customized setting remains after turning the machine off and on.

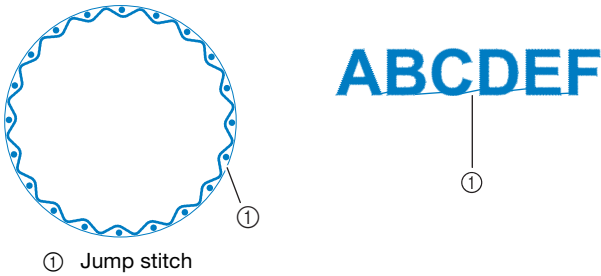

- 1 Touch .
- 2 Touch  to turn off the thread trimming function.

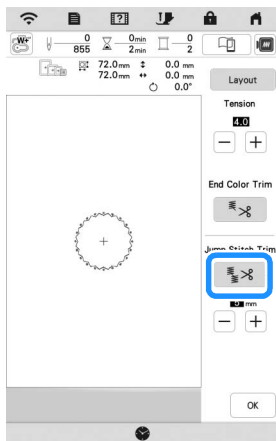

→ The key will display as . The machine will not trim the thread before moving to the next stitching.

Selecting the Length Of Jump Stitch Not to Trim

When the thread trimming function  is turned on, you can select the length of the jump stitch. Select a setting from 5 mm to 50 mm in 5 mm increments.

* Your customized setting remains after turning the machine off and on.

Touch  or  to select the length of jump stitch.



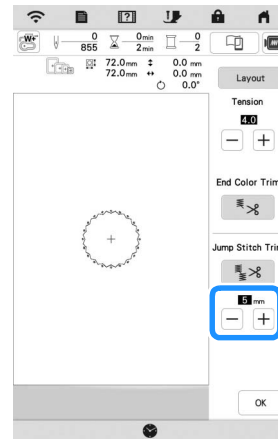

For example: Touch  to select 25 mm (approx. 1 inch) and the machine will not trim a jump stitch of 25 mm or less before moving to the next stitching.



Note

- If design has many trims it is recommended to select a higher jump stitch trim setting in order to reduce the amount of excess tails on backside of fabric.
- The higher number of the jump stitch length selected, the fewer number of times the machine will trim. In this case, more jump stitches remain on the surface of the fabric.

Adjusting the Embroidery Speed

- 1 Touch .
 - The settings screen appears.
- 2 Touch .
 - The embroidery settings screen appears.
- 3 Display [Max Embroidery Speed] in the embroidery settings screen.
- 4 Use   to change the maximum embroidery speed.

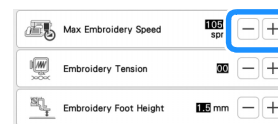

Memo

- SPM is the number of stitches embroidered in one minute.
- Decrease the embroidery speed when embroidering on thin, thick, or heavy fabrics and when using a specialty thread like a metallic thread.
- The setting specified before the main power is set to OFF remains selected the next time that the machine is turned ON.

- 5 Touch .

Changing the Thread Color Display

You can display the name of the thread colors or embroidery thread number.

Memo

- Colors on the screen may vary slightly from actual spool colors.
- [Original], imported data remains the brand thread created with the software, is set as a default.



1 Touch .

→ The settings screen appears.



2 Touch .

→ The embroidery settings screen appears.

3 Display [Thread color] in the embroidery settings screen.

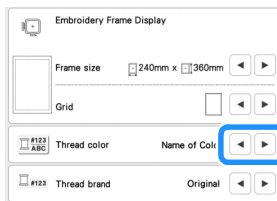
4 Use   to display the name of the thread colors or the embroidery thread number.



5 Use   to select a thread brand.

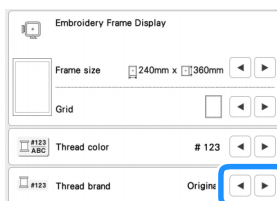

6 Touch .

Aligning the Pattern and the Needle

Example: Aligning the lower left side of a pattern and the needle

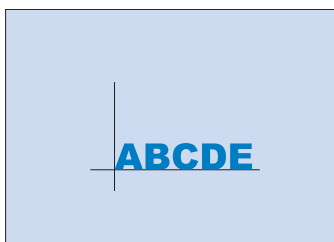

1 Mark the embroidery start position on the fabric, as shown.

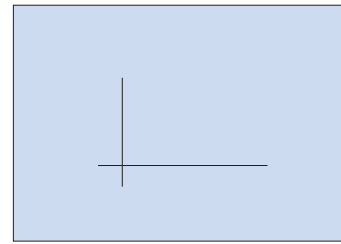

2 Touch .



3 Touch .

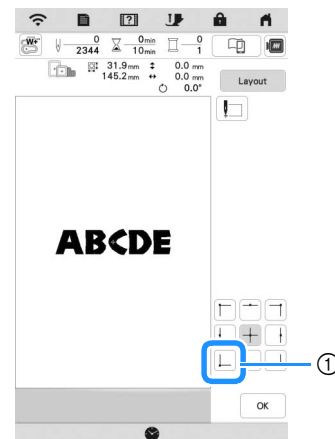

① Start position

→ The needle is positioned in the lower-left corner of the pattern. The carriage moves so that the needle is positioned correctly.

4 Touch .

5 Touch  and then, touch .

6 Use  to align the needle and the mark on the fabric, and start embroidering the pattern.

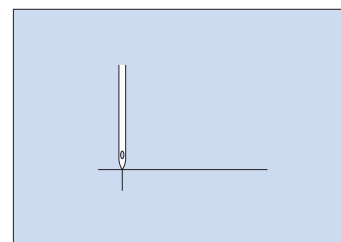

Embroidering Linked Characters

Follow the procedure described below to embroider linked characters in a single row when the entire pattern extends beyond the embroidery frame.

Example: Linking "FG" to the characters "ABCDE"

ABCDEF G

1 Select the character patterns for "ABCDE".

2 Touch .



3 Touch .

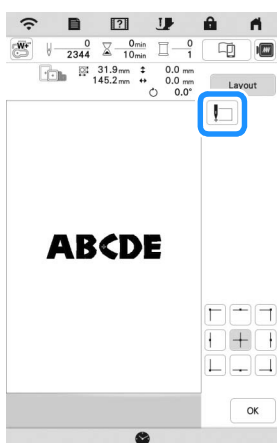

→ The needle is positioned in the lower-left corner of the pattern. The carriage moves so that the needle is positioned correctly. The machine is set to embroider until the first stitch of the next character pattern (F).

Note

- To cancel the starting point setting and return the starting point to the center of the pattern, touch

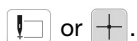



- Using  can select a different starting point for embroidering. However, the starting point setting is canceled.

4 Touch .

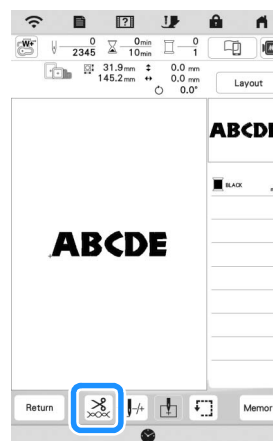
5 Touch .



6 Touch  to turn off the thread cutting function and then touch .

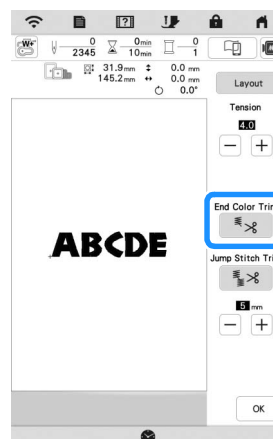

7 Press the "Start/Stop" button.

8 After the characters are embroidered, cut the threads to a generous length, remove the embroidery frame, reposition the fabric in the hoop so that the remaining characters ("FG") can be embroidered, and then attach the embroidery frame.

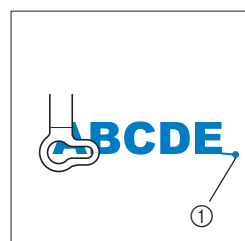



① End of the embroidering

9 As in step 1, select the character patterns for "FG".

10 Touch .

11 Touch .

→ The needle is positioned in the lower-left corner of the pattern. The carriage moves so that the needle is positioned correctly.

12 Touch , then  and use  to align the needle with the end of embroidering for the previous pattern.



13 Touch .

14 Press the "Start/Stop" button to start embroidering the remaining character patterns.



USING THE MEMORY FUNCTION

Saving Embroidery Patterns

Note

- Do not turn the main power to OFF while the [Saving...] screen is displayed. You will lose the pattern you are saving.

1 Touch  when the pattern you want to save is in the embroidering screen.

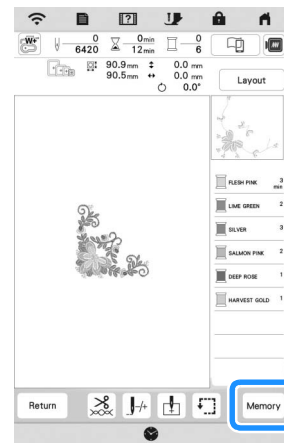

Memo

- You can also save the pattern by touching  in the embroidery edit screen.

2 When saving the embroidery pattern in a USB media, insert the USB media into the USB port on the machine.

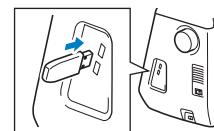

3 Touch the desired destination to start saving.

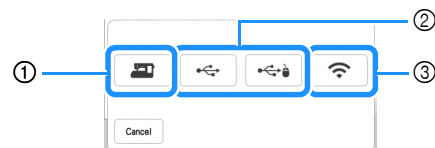

- 1 Save to the machine's memory.
- 2 Save to the USB media. The pattern is saved in a folder labeled [bPocket].
- 3 Save to the wireless function pocket. For the detailed procedure, refer to the manual for PE-DESIGN (version 11 or later).

Retrieving Embroidery Patterns

1 When retrieving the embroidery patterns from a USB flash drive, insert the USB flash drive into the USB port on the machine.

To retrieve embroidery patterns via wireless network, use PE-DESIGN (version 11 or later) or Design Database Transfer to transfer the patterns in advance. For details on transferring embroidery patterns, refer to the manual for PE-DESIGN or Design Database Transfer.

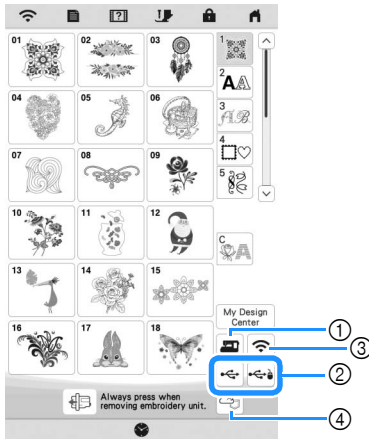

- ① Retrieve from the machine's memory.
- ② Retrieve from a USB media.
- ③ Retrieve the pattern via the wireless network connection. For detailed procedures, refer to PE-DESIGN manual (Version 11 or later).
- ④ Retrieve from Artspira App. (pages 180)

Memo

- If the embroidery pattern to be retrieved is in a folder of the USB media, touch the key for that folder. Touch to return to the previous screen.
- You can save all or multiple data to the machine by touching .

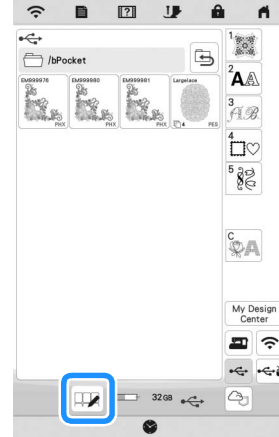

- To select multiple patterns, touch their thumbnails.
- : Select all patterns.
- : Deselect all patterns.
- : Save the selected patterns to the machine.
- * To cancel the selection, touch again.

2 Touch .

- * Touch to delete the embroidery pattern.

EMBROIDERY APPLICATIONS

Using a Frame Pattern To Make an Appliqué

Note

- If you change the size or position of the patterns when making an appliqué, make a note of the size and the location.

Method 1

You can use framed patterns of the same size and shape to create an appliqué. Embroider one pattern with a straight stitch and one pattern with a satin stitch.

- 1 Select a straight stitch frame pattern. Embroider the pattern onto the fabric for the appliqué piece, then cut neatly around the outside of the shape.

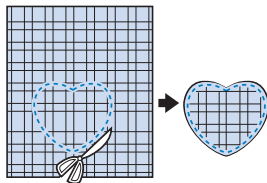
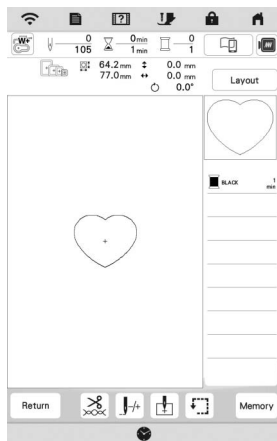

- 2 Embroider the same pattern from step 1 onto the base fabric.
- 3 Apply two-sided stabilizer material to the back of the fabric for the appliqué piece created in step 1. Attach the appliqué to the base fabric matching the shapes.

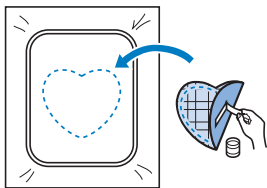

- 4 Select the satin stitch frame pattern of the same shape as the appliqué. Embroider over the fabric for the appliqué piece and base fabric from step 3 to create the appliqué.

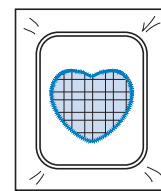
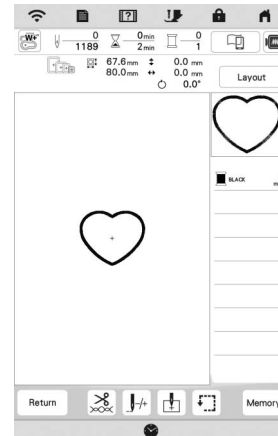
**Method 2**

- 1 Select a straight stitch frame pattern, and embroider the pattern onto the base fabric.

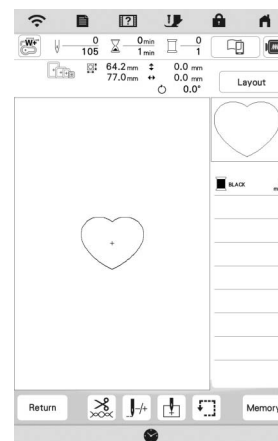

- 2 Place the fabric for the appliqué piece over the pattern embroidered in step 1 and embroider the same pattern on the fabric for the appliqué piece.

* Be sure that the fabric for the appliqué piece completely covers the stitched line.

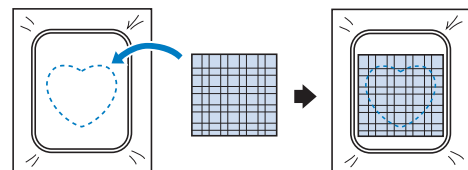

- Remove the embroidery frame from the embroidery unit, and cut around the outside of the stitches of the fabric for the appliqué piece. And then, reattach the embroidery frame to the embroidery unit.

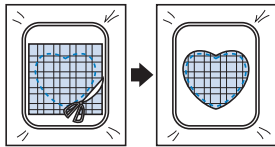

Note

- Do not remove the fabric from the embroidery frame to cut it. Also, do not pull or push on the fabric. Otherwise, the fabric may loosen in the frame.

- Select the satin stitch frame pattern of the same shape as the appliqué and embroider the satin stitch pattern to create an appliqué.

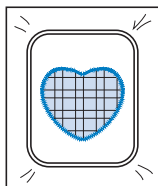
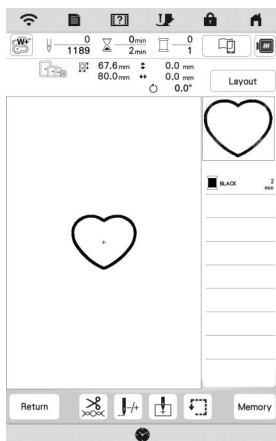

Embroidering Couching Patterns

Couching patterns can be embroidered using yarn.



CAUTION

- When using yarn, we recommend selecting yarn of weight 4 (MEDIUM (4)). Medium yarn is often referred to as worsted weight, 20 knitted stitches per 10 cm, or 9-11 wraps per inch. The diameter of the yarn is approximately 2-3 mm (approx. 1/12-1/8 inch). If the yarn is extremely thin or thick, has an unusual shape (flat or furry), or more than 2 yarns, the best finishing results may not be achieved, or injuries or damage may result.

Note

- If the spool stand in the procedure is not included with your machine, purchase the optional spool stand from your Brother authorized dealer or our web site <https://s.brother/coeka/>.
- Before embroidering your project, do trial embroidery on a scrap piece of fabric that is the same as that used in your project.

■ Preparing for Embroidery Couching

- Turn off the machine. Attach the embroidery unit.
- Install a bobbin wound with embroidery bobbin thread.
- Turn on the machine.
- Touch , and then touch .



5 Select the desired pattern from the desired category.

And then touch .

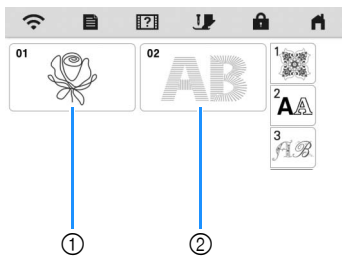

- ① Couching patterns
- ② Fill couching embroidery font

6 Touch to lock all keys and buttons, and then raise the presser foot lever.

7 Attach embroidery couching foot "Y".

- * Attach the embroidery couching foot through the front of the buttonhole lever.

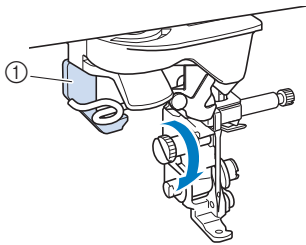

- ① buttonhole lever

! CAUTION

- When using the embroidery couching foot "Y", make sure the machine is in embroidery mode. Otherwise, the needle will strike the embroidery couching foot, causing the needle to break and possibly causing injury.

8 Rotate the handwheel and check that the needle is in the left half of the hole in embroidery couching foot "Y".

If the needle is not in the left half, use the multi-purpose screwdriver to turn the screw of embroidery couching foot "Y" to adjust the position of the embroidery foot. Turn the screw toward you to move the embroidery foot to the right. Turn the screw toward the back to move the embroidery foot to the left. After making adjustments, rotate the handwheel and check that the needle does not touch the presser foot.

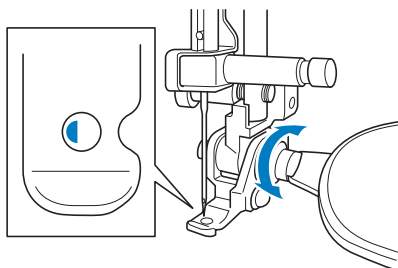

9 Attach the spool stand (included with some models) to the machine.

At this time, do not raise the telescopic thread guide shaft.

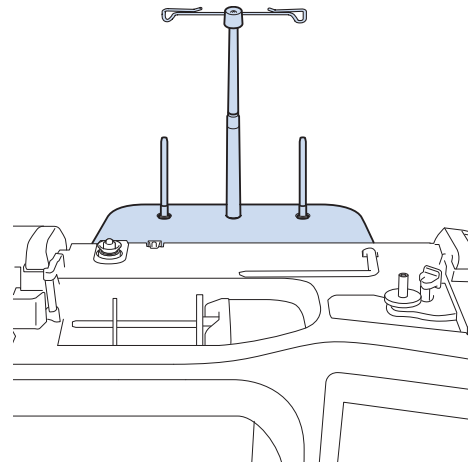

- * Refer to "Using the Spool Stand" on page 41.

10 Insert the yarn guide for embroidery couching into the slot on the top left of the machine.

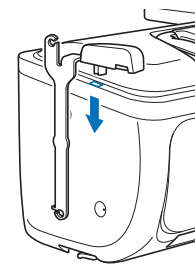

11 Pass the yarn through the telescopic thread guide and the yarn guide (①) to (②).

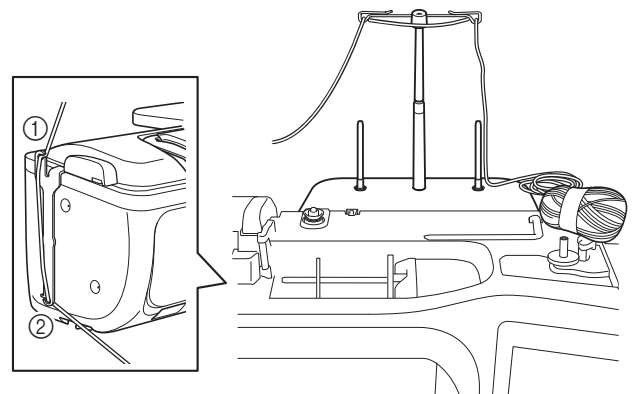

Note

- Pull off an appropriate amount of yarn from the ball so that the yarn does not become taut.
- Make sure that the yarn does not become entangled as you work.

- 12 Pass the yarn through the guide on embroidery couching foot “Y”.

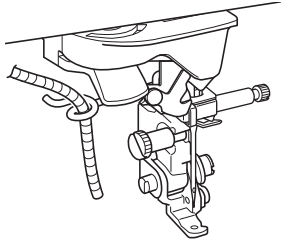

- 13 Thread the yarn through embroidery couching foot “Y”.
Pass the yarn through the loop in the yarn threader, and then pass the threader from top to bottom through the hole in embroidery couching foot “Y”. Pull the yarn to the front of the machine.

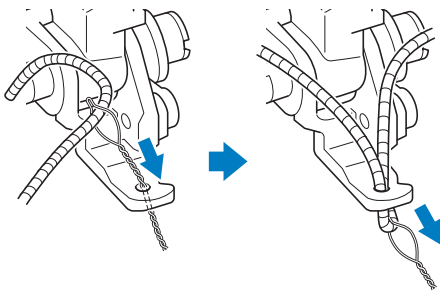

Memo

- Place a sheet of paper under the presser foot to smoothly pass the yarn threader through the hole in embroidery couching foot “Y”.

- 14 Touch  to unlock all keys and buttons.

- 15 Thread the machine with the upper thread.

Note

- Do not use the spool stand for upper thread. Otherwise thread may tangle with yarn.

Memo

- For best results, use an upper thread that is the same color as the yarn.

- 16 Press  (Presser foot lifter button) twice to raise the presser foot and then attach the embroidery frame to the embroidery unit.

■ Embroidering a Couching Pattern

- 1 Touch .

- 2 Make sure that about 20 cm (approx. 8 inches) of yarn is pulled to the front of the machine.

- 3 While holding the yarn in your hand in front of you, press the “Start/Stop” button.

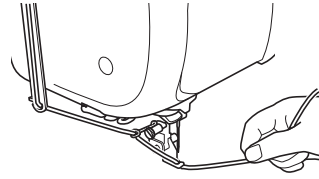

CAUTION

- Pulling the yarn upwards may cause it to catch on the needle, causing it to break. Be careful not to allow the yarn to catch on the needle.

Note

- Before embroidering, make sure that there is enough yarn, upper thread and bobbin thread.
- Make sure that the yarn passes smoothly through the guides. Unravel as much yarn from the ball as necessary so that the yarn does not become taut.
- Use yarn that has no knots.

- 4 After embroidering several stitches, release the yarn.

→ When embroidering is finished, the machine will automatically trim the threads and stop.

Memo

- When using a high-density yarn, the upper thread tension may be disturbed. If this happens, it is possible to improve it by raising the [Embroidery Foot Height] by about 1 mm on the settings screen.

- 5 Cut the yarn, leaving about 20 cm (approx. 8 inches).

- 6 Punch a hole through the fabric with an awl or tapestry needle and then use the yarn threader to pull the excess yarn to the wrong side of the fabric.

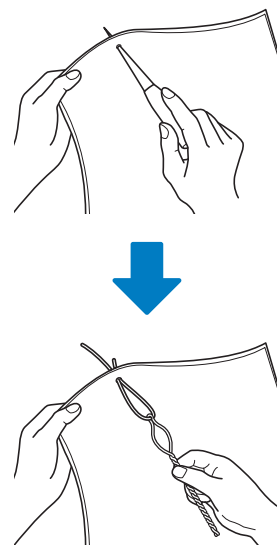

- 7 Tie the end of the yarn so it cannot be pulled out, and then use scissors to cut off any excess yarn.

Creating Stippling, Echo Quilting, or Decorative Fill Patterns around a Design

Stippling, echo quilting, and decorative fill patterns can be created around the machine's built-in patterns or original embroidery data without using My Design Center.

Memo

- If this simple stippling operation is used with batting sandwiched between two layers of fabric, the embroidery pattern and stippling may become misaligned.

Stippling can be added in My Design Center after the pattern is embroidered. For details, refer to "Decorative Stitching around a Pattern in Embroidery (a Quilting Function)" on page 176.

1 Select the pattern that stippling will be added around.

- * To select multiple patterns, refer to "Selecting Multiple Patterns at the Same Time" on page 110.



2 Touch in the embroidery edit screen.

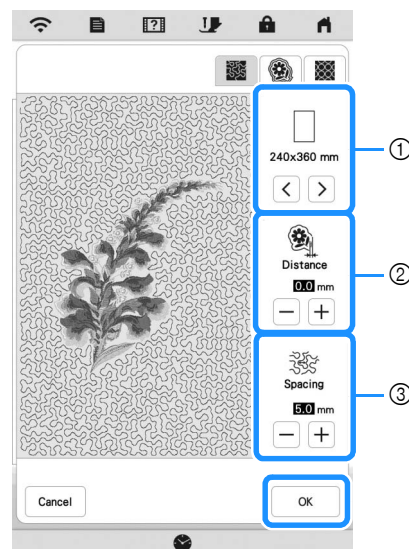

→ Stippling is automatically applied around the selected pattern.

3 After specifying the stitch settings for the stippling, touch , and then touch .



- ① The stippling is added within the area of the selected frame size. If the pattern is larger than the selected frame size, the area indicating the frame size will appear in gray, and stippling will not be added.
 - ② Specify the distance from the outline of the pattern to the stippling.
 - ③ Specify the spacing for the stippling.
- * Touch  in the stippling settings screen to create an echo quilting pattern.
 - * Touch  in the stippling settings screen to create a decorative fill pattern.

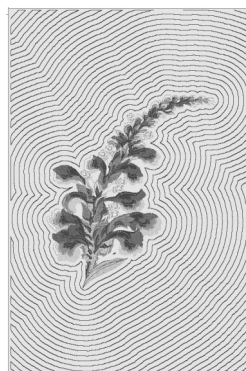

①



②

- ① Echo quilting pattern
- ② Decorative fill pattern

Embroidering Split Embroidery Patterns

Split embroidery patterns created with PE-DESIGN Ver. 7 or later can be embroidered. With split embroidery patterns, embroidery patterns larger than the embroidery frame are divided into multiple sections, which combine to create a single pattern after each section is embroidered.

For details on creating split embroidery patterns and for more detailed embroidery instructions, refer to the Instruction manual included with PE-DESIGN Ver. 7 or later.

- 1 Insert the USB media containing the created split embroidery pattern, and then select the split embroidery pattern to be embroidered. (page 154)

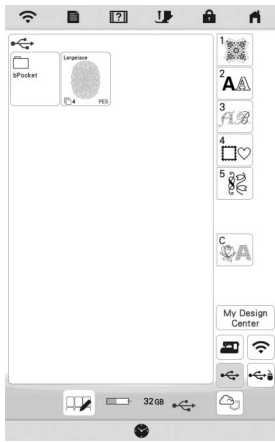

- 2 Select section 001 to be embroidered.

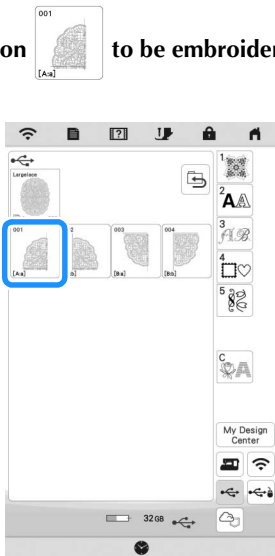

- 3 Touch **Set**.

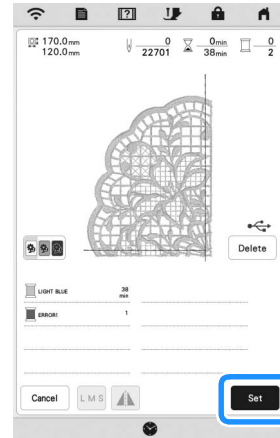

- 4 If necessary, touch **Edit** and edit the pattern.

Touch **Embroidery** to display the embroidery screen.

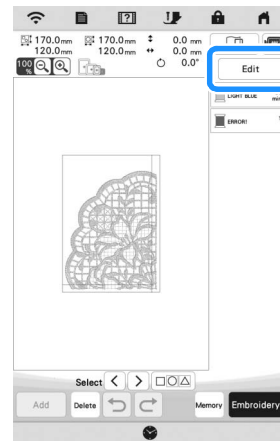

- 5 Embroider the pattern section.

- 6 When embroidering is finished, the following screen appears. Touch **OK**.

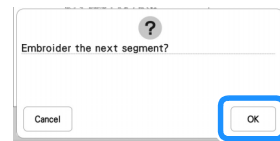

→ A screen appears so that a section of the split embroidery pattern can be selected.

- 7 Repeat steps 2 through 6 to embroider the remaining sections of the pattern.

Chapter 6 MY DESIGN CENTER

ABOUT MY DESIGN CENTER

With My Design Center, you can use the functions listed below:

- Hand-drawn functions - creating embroidery patterns by drawing on the LCD screen
- Loading functions - creating embroidery patterns by transferring data from the application or USB media.

You can also combine patterns that you have created with the machine's built-in patterns.

Start My Design Center by touching  in the home page screen or touching  in the embroidery pattern selection screen.

PATTERN DRAWING SCREEN

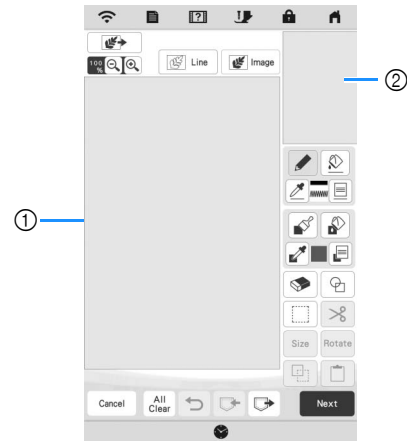

- ① Pattern drawing area
- ② Pattern preview area

Memo

- The actual dimension of the pattern area is the size of the embroidery frame, which is shown in the pattern preview area. The pattern you drew may be bigger than you expected. Please resize the pattern after converting the design to the embroidery pattern.
- When the pattern is enlarged so that only a part of it appears in the pattern drawing area, the entire pattern is displayed in the pattern preview area. The red frame in the pattern preview area indicates the part of the pattern displayed in the pattern drawing area. Move the red frame in the pattern preview area with the touch pen (stylus) or your finger to display the corresponding area in the pattern drawing area.

■ Key Functions

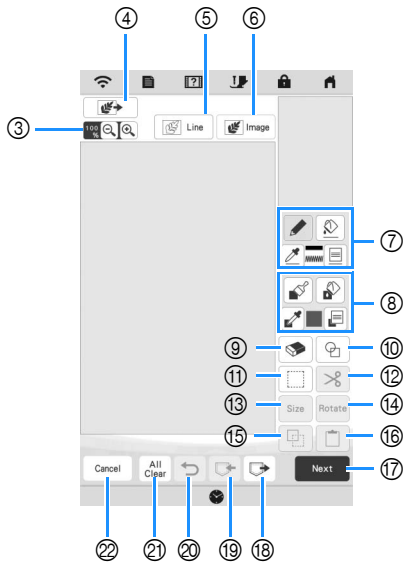

No.	Display	Explanation	Page
	Name		
③		Magnify the pattern.	164
	Magnify key		
④		Load the fabric as the background or the picture as the reference when creating the pattern. You can load the image file from the application or USB media.	169
	Load key		
⑤		Load a line drawing, then edit and convert it to embroidery data. You can load a line drawing from the application or USB media to create the embroidery design.	170
	Line design key		
⑥		Load an image, then edit and convert it to embroidery data. You can load an image from the application or USB media to create the embroidery design.	172
	Image design key		
⑦		Draw lines and set the color. You can select the line type, stitch type and color as you need. Touch to pick up the color, line type and stitch type from a line in the pattern within the pattern drawing area. The picked up color is shown as the currently selected line color beside the button and as the selected color in the Line Property screen.	163
	Line tool key		
⑧		Paint with brush and set the color. You can select the brush type, fill type and color as you need. Painted lines and regions will be converted to the pattern to be embroidered with fill stitch. Touch to pick up the color, brush type and fill type from a region in the pattern within the pattern drawing area. The picked up color is shown as the currently selected region color in the color bar and the Region Property screen.	164
	Brush tool key		

No.	Display	Explanation	Page
	Name		
⑨		Erase lines and shapes that have been drawn. You can select the size/shape of the eraser.	166
	Erase key		
⑩		Select the stamp shape for pattern drawing.	165
	Stamp key		
⑪		Select a section for moving, copying, deleting, changing size and rotating lines and shapes that have been drawn.	166
	Select key		
⑫		Cut out the selected section.	—
	Cut key		
⑬		Change the size of the selected section.	174
	Size key		
⑭		Rotate the selected section.	—
	Rotate key		
⑮		Duplicate the selected section. The temporarily positioned section can immediately be rotated, enlarged, reduced or moved.	—
	Duplicate key		
⑯		Paste in the selected section duplicated with the duplicate key or a selected section using the cut key.	—
	Paste key		
⑰		Proceed to the stitch settings screen.	—
	Next key		
⑱		Recall image data created with My Design Center from the machine's memory or the USB media.	—
	Recall key		
⑲		Store the pattern being created to the machine's memory or the USB media.	—
	Memory key		
⑳		Undo the last operation that was performed and return to the previous state. Each touch of this key will undo one operation.	—
	Undo key		
㉑		Clear all the lines and shapes and start from the beginning. The background image is also cleared.	—
	All Clear key		
㉒		Exit from My Design Center. All lines and shaped are erased when you touch this key.	—
	Cancel key		

Before Creating Designs

The pattern preview displays the design smaller than the actual size. You can view the actual pattern size by setting the [Embroidery Frame Display].

With [Embroidery Frame Display] in the settings screen, the embroidery frame and grid can be specified separately.

- 1 Touch .
→ The settings screen appears.
- 2 Touch .
→ The embroidery settings screen appears.
- 3 Display [Embroidery Frame Display] in the embroidery settings screen.
- 4 Select the embroidery frame display.

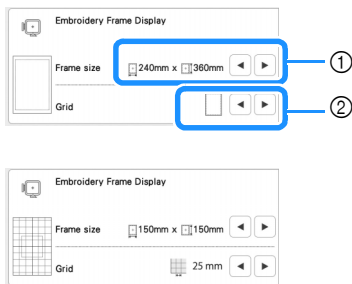

- ① Embroidery frame types
- ② Grid types

Drawing Lines

- 1 Touch and draw lines.

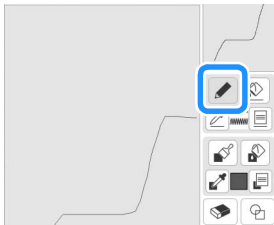

Memo

- When is touched, all regions will be displayed in the background to clarify the drawing lines on the screen.

Setting the Line Types, Stitch Types and Colors

You can set or change the line types, stitch types and colors anytime. You can also specify the line types, stitch types and colors before drawing lines.

- 1 Touch to set the line types, stitch types and colors.

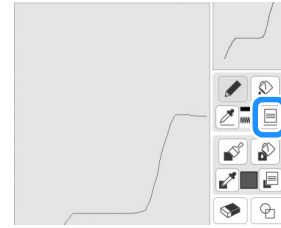

→ The settings screen appears.

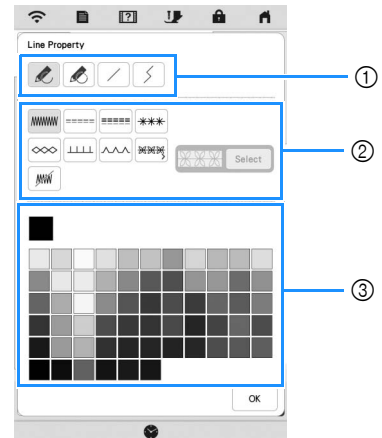

- ① Line types
- ② Stitch types
- ③ Line color selection: touch the color palette to activate the drawing pen color.

Line types

	Freehand line with the end open.
	Freehand line closing the end automatically.
	Straight line with one stroke
	Straight line changing directions to the point you select. If the end point is created near the start point, a closed object will be created.

Stitch types

	Zigzag stitch
	Running stitch
	Triple stitch
	Candlewicking stitch
	Chain stitch
	E stitch
	V stitch
	Select motif stitches Displays motif stitch selection screen, where can be touched to select a pattern.
	Line without stitch for creating a region. Created region will be defined by the gray line.

2 Touch to return to the pattern drawing screen.

→ You can check the selected stitch type and color.

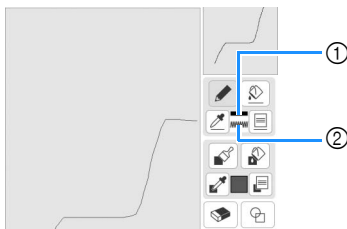

- ① Color bar
- ② Stitch type

3 Touch then touch on the line to change its color.

→ The connected line will be changed to the selected color.

Memo

- Touch to magnify the image when you cannot touch on the line correctly.
- Touch , and then select a color within the pattern drawing area to apply the same color to other lines or parts of the pattern.

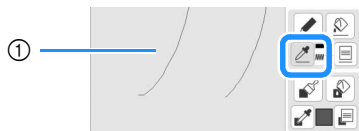

① Use to select the line color.

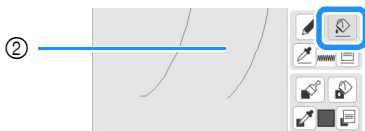

② Touch for changing the line color, and then select the pattern to be changed.

Drawing Regions

1 Touch and draw with brush.

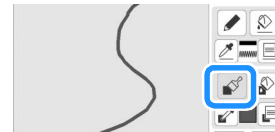

■ Setting the Brush Types, Fill Patterns and Fill Colors

1 Touch to set the brush types, fill patterns and fill colors.

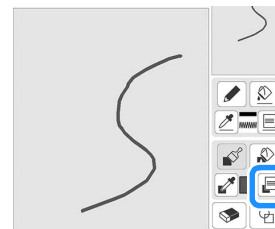

→ The setting screen appears.

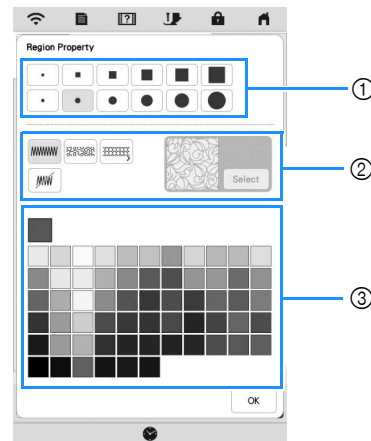

- ① Brush types
- ② Fill stitch types
- ③ Fill color selection: touch the color palette to activate the paint brush color.

Brush shapes/sizes



Fill stitch types

	Fill stitch pattern
	Stippling pattern

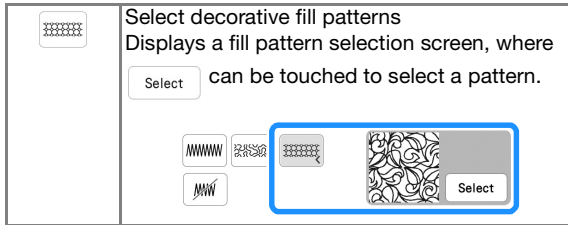

Select decorative fill patterns
Displays a fill pattern selection screen, where
Select can be touched to select a pattern.

Select when you don't want fill stitch.

2 Touch to return to the pattern drawing screen.

→ The color bar on the brush tool key is changed to the selected color. If a stippling pattern or decorative fill pattern has been selected, the stitch pattern is displayed.



① Color bar

3 Touch and touch on the brush line to change color and fill stitch type. You can also set the fill color, stitch type and fill pattern of a closed area made of the lines and brush lines.

Memo

- Touch to magnify the image when you cannot touch on the fill correctly.
- Touch , and then select a pattern color in the pattern drawing area to apply that fill color and stitch type to other patterns.

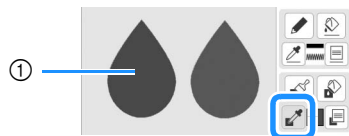

① Use to select the fill color.

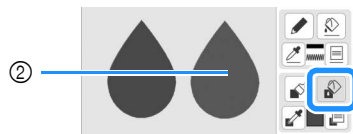

② Touch for changing the fill color and stitch type, and then select the pattern to be changed.

Using the Stamp Key

1 Touch .

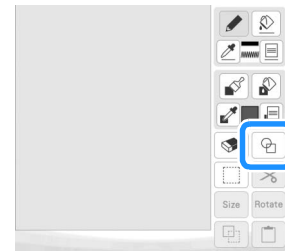

2 Select a stamp type and stamp shape.

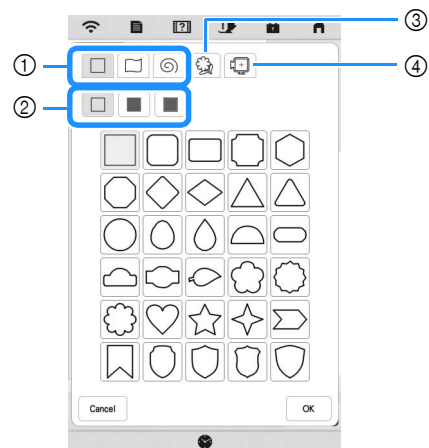

- ① Stamp shapes
- ② Stamp types
- ③ Saved outlines
- ④ Frame embroidering areas

Stamp shapes

	Basic shapes
	Closed shapes
	Open shapes

Stamp types (Only for Basic shapes)

	Outline
	Fill stitch
	Outline and fill stitch

* Select the outline () , fill stitch () , or outline and fill stitch () of a basic shape.

Saved outlines

	<p>Embroidery pattern outlines can be registered as stamp shapes. When registering stamp shapes, select from the last 20 embroidery patterns used. If more than 20 shapes are registered, the oldest one is automatically erased. For details on registering a stamp shape, refer to “Decorative Stitching around a Pattern in Embroidery (a Quilting Function)” on page 176.</p>
---	---

Frame embroidering areas

	<p>Select an embroidering area in order to arrange the pattern to fit an embroidery frame.</p>
---	--

* Touch to return to the pattern drawing screen.

3 Touch to set the selected stamp.

→ The pattern drawing screen appears.

* You can change size of, rotate or move the shape right after you create it by touching or .

Using the Erase Key

1 Touch .

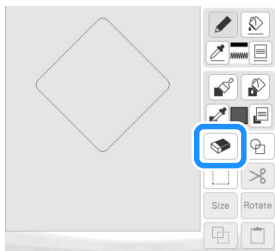

2 Select the shape of the eraser.

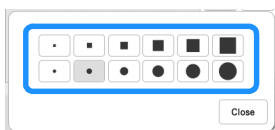

→ The pattern drawing screen appears.

3 Drag along the area or line that you want to erase while the key appears as .

Using the Select Key

You can select the part of the design to move and/or edit. Some keys are available only after you select the part.

1 Touch .

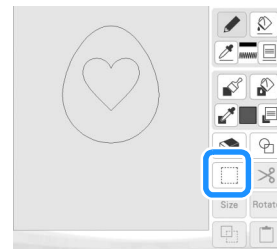

2 Select the area you want to edit.

* Drag to create the red box around your selected area to be edited.

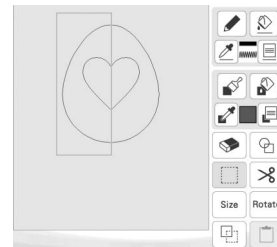

3 Edit the design with available keys. (Refer to “Key Functions” on page 162 for the details of each key function.)

4 Touch , and then specify the stitch setting.

STITCH SETTINGS SCREEN

After creating the pattern drawing data (.pm9) in the drawing screen (page 161), you will have an opportunity to:

- Check and change the stitch settings for each line and region.
- Save the pattern drawing data (.pm9).
- Convert the data to an embroidery pattern (.phx), proceed to the embroidery edit screen, and/or save the embroidery pattern.

Specifying Individual Stitch Settings

Select a pattern in the stitch settings screen to specify its line and region stitch settings. If multiple patterns are selected, the settings are applied to those patterns.

Line Settings

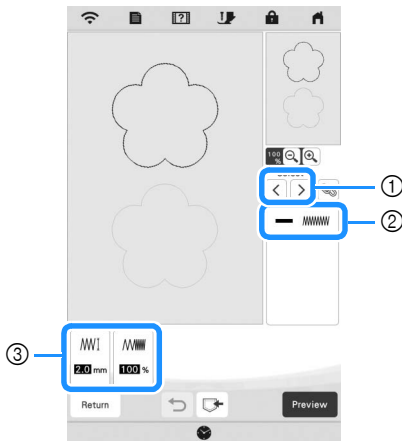

- 1 Select the line to be changed.
- 2 Shows the stitch type and color for the selected line.
- 3 Shows the stitch settings for the selected line.

Line stitch settings

Select the type of stitching you want applied to your line art.

Zigzag stitch

[Zigzag width]	Specifies the width of the stitch.
[Density]	Specifies the density of the stitch.

Running stitch / Triple stitch

* Both includes an under sewing.

[Run Pitch]	Specifies the length of the stitch.
-------------	-------------------------------------

Candlewicking Stitch

[Size]	Increases/reduces the size of the stitch.
[Spacing]	Specifies the spacing of the stitch.

Chain stitch

[Size]	Increases/reduces the size of the stitch.
[Thickness]	Sets repeated embroidering at the same part.

E stitch

[Stitch width]	Increases/reduces the size of the pattern.
[Spacing]	Specifies the spacing of the E stitch.
[Thickness]	Sets repeated embroidering at the same part.
[Flip]	Specifies if the decorative line shows up inside or outside.

V stitch

[Stitch width]	Increases/reduces the size of the pattern.
[Spacing]	Specifies the spacing of the V stitch.
[Thickness]	Sets repeated embroidering at the same part.
[Flip]	Specifies if the decorative line shows up inside or outside.

Motif stitch



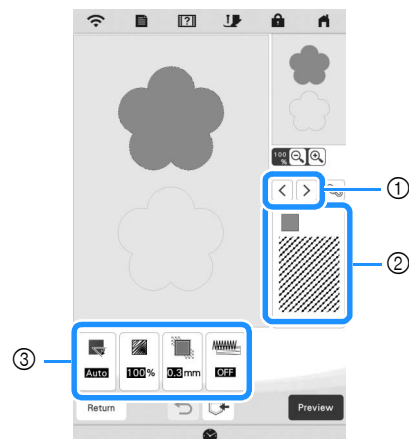

[Size]	Increases/reduces the size of the pattern.
[Spacing]	Specifies the spacing of the motif stitch.
[Flip]	Specifies if the decorative line shows up inside or outside.

Region Settings





- 1 Select the region to be changed.
- 2 Shows the stitch type and color for the selected region.
- 3 Shows the stitch settings for the selected region.



Fill stitch settings 

 [Direction]	Specifies the embroidering direction. Select Manual to change to the desired direction of fill stitch.
 [Density]	Specifies the stitch density of fill stitch.
 [Pull compensation]	Specifies to correct the shrinkage of the pattern by slightly shortening or lengthening the stitching. Change the setting after you test embroider the pattern and can check the shrinkage.
 [Under sewing]	Select if you need or do not need the under sewing for the stabilized fabric.



Stippling stitch settings 

 [Run Pitch]	Specifies the length of a stitch of the stippling stitch.
 [Spacing]	Specifies the spacing between the stitches when embroidering the stippling stitch.
 [Distance]	Specifies the offset from the pattern outline.

Decorative fill stitch settings 

 [Size]	Increases/reduces the size of the pattern.
 [Direction]	Specifies the rotation angle of the pattern.
 [Outline]	Select whether [ON] or [OFF] the outline is also converted to embroidery data. If [ON] is selected, the number of thread jumps can be reduced.

1 Use   to select the line or region to be changed.



→ Each touch of   moves the highlighting of the selected pattern in order.

2 Select the setting to be changed, and then change the setting in the screen that appears. (In this example, the embroidering direction will be changed.)

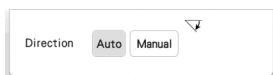

→ The setting screen appears.



3 Touch **Manual**, and then use   to change the direction.

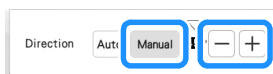



4 Touch **Set** to apply the setting.

- *  appears on the tab for settings that were changed.
- * Change other settings in the same way.

Specifying Global Stitch Settings

The same stitch settings can be changed at the same time for multiple patterns of the same type.

1 Use   to select the stitch whose settings are to be changed, and then touch .

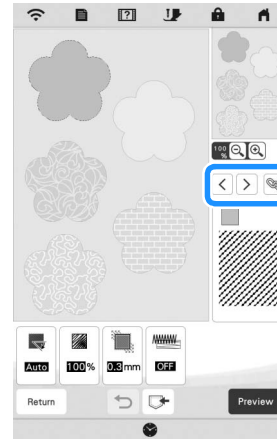

→ The same stitch type lines or regions will be selected at the same time.

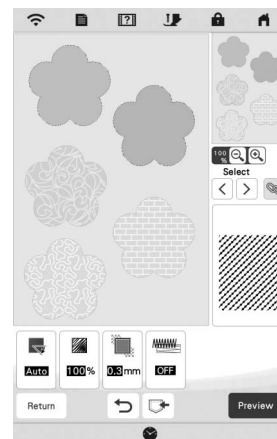

2 Follow steps 2 through 4 in “Specifying Individual Stitch Settings” on page 167 to change the settings.

3 Touch **Preview** to create the embroidery pattern.

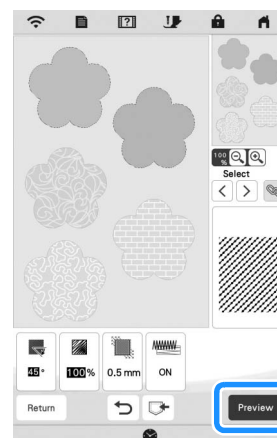

→ When the following message appears, touch .

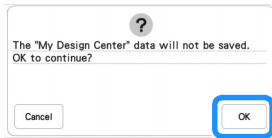

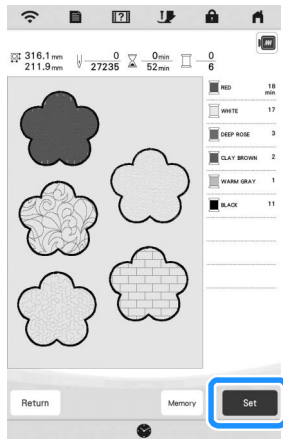

4 Touch  to display the pattern editing screen.

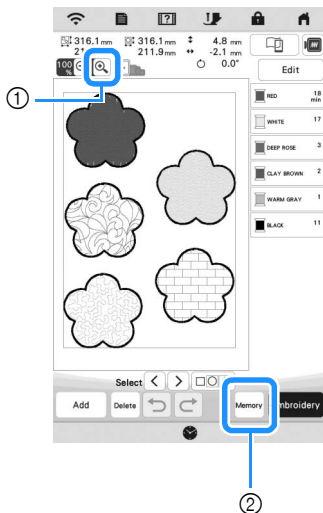
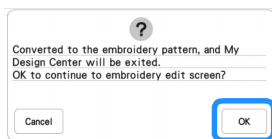

→ When the following message appears, touch .



- ①  : Check an enlarged view of the pattern.
- ②  : Save the embroidery data.

Loading the Background Image

Prepare the data file of your favorite picture so that you can create an embroidery pattern. Load the image file from the application “MY DESIGN SNAP APP” on page 179 or a USB media.

1 Touch .



2 Select the device you saved the data to.



3 Select the data, and then touch .

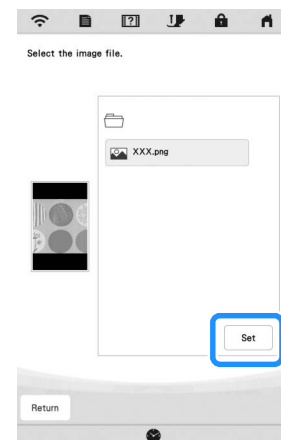

4 The selected image is displayed transparently in the pattern drawing area.





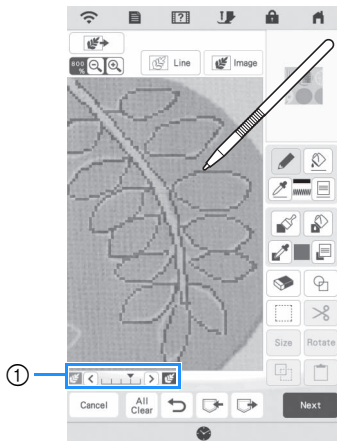

5 Using the included touch pen (stylus), touch , and then draw lines to trace the image.

* For details on drawing lines, refer to “Drawing Lines” on page 163.



① Transparency adjustment

* Touch  or  to adjust the transparency of the background.

Each touch of  lightens the background, making the line pattern darker. Each touch of  darkens the background, making the line pattern lighter.

6 After editing the pattern, touch  to specify the settings for pattern.

7 Touch  to create the embroidery pattern.

LINE CONVERSION

Custom patterns can be created from drawings. You can create patterns by loading an image on the application “MY DESIGN SNAP APP” on page 179 or a USB media.

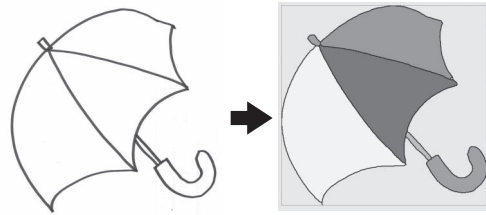

Recommended line drawings for Line Conversion

- Line drawings must be drawn clearly using lines with approximately 1 mm thickness.
- Line drawings should be drawn in a strong contrast.
- If the lines are too short or gathered too densely, they will not be loaded correctly.

Note

- For details on creating patterns using color illustrations, refer to “ILLUSTRATION CONVERSION” on page 172.
- If you cannot convert the drawings as expected, you can edit the design in My Design Center. Refer to “PATTERN DRAWING SCREEN” on page 161.
- Line drawings are converted without recognizing the thickness of lines. If you want to change the thickness of lines, specify in the settings screen. Refer to “STITCH SETTINGS SCREEN” on page 167.
- Line drawings are converted as black lines. If you want to change the colors, specify in My Design Center. Refer to “Drawing Lines” on page 163.

Create a Pattern with Line Conversion

1 Touch .

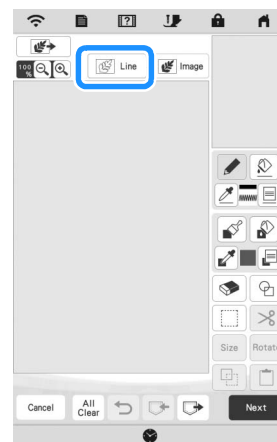

→ The image display screen appears.

2 Select the device you saved the data to.



3 Select the data, and then touch **Set**.

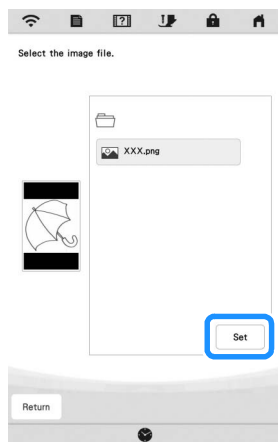

4 When loading is finished, specify the [Gray-Scale Detection level] on the screen if necessary.

The [Gray-Scale Detection level] can change the black and white threshold for the image.



- * If you do not know how the settings should be changed, first continue the operation without specifying settings and check the results.
- * To stop loading and return to the screen in step 2, touch **Cancel**. The loaded image will be deleted when you return to the previous screen.

5 Move to frame the image for the pattern.

6 Touch **OK**.

→ The screen for confirming the converted image appears.

7 In the screen for confirming the converted image, you can adjust the [Gray-Scale Detection level] again, if necessary.

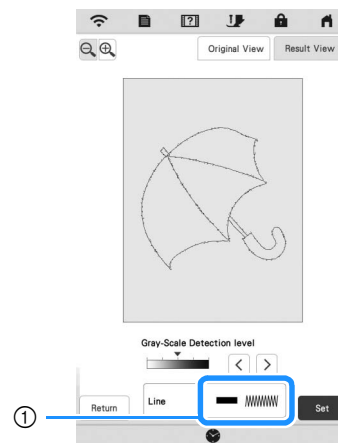

① The settings for the lines to be embroidered appear.

- * If you do not know how the settings should be changed, first continue the operation without specifying settings and check the results.

- *  : Enlarge the image.

- * **Original View** : Display the image before being converted. Compare the images before and after being converted, and then change the settings if necessary.

- * **Return** : Return to the previous screen.

→ After changes to the settings for [Gray-Scale Detection level] are applied, **Set** changes to **Retry**. Touch **Retry** to check that the image is as desired.

8 Touch **Set**.

→ The pattern drawing screen appears.

9 If necessary, edit the loaded image.

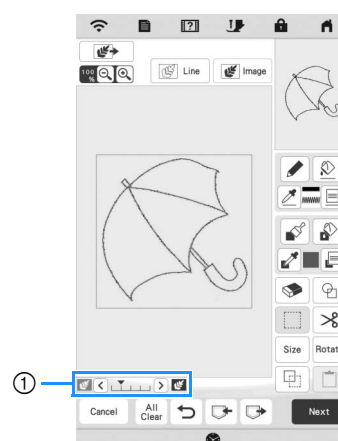



- * After the loaded image is converted to stitching, it appears as a background in the pattern drawing screen. Use gauge ① to adjust the transparency of the background. Each touch of  lightens the background, making the line pattern darker. Each touch of  darkens the background, making the line pattern lighter.

ILLUSTRATION CONVERSION

Custom patterns can be created from color illustrations. You can create patterns by loading an image on the application "MY DESIGN SNAP APP" on page 179 or a USB media.

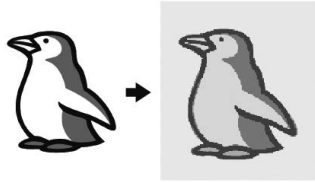

Recommended illustrations for Illustration Conversion

- Illustrations that are clearly drawn, with no gradation, fading or blurriness.
- Illustrations that are at least a 5 mm square
- Illustrations that are extremely simple images

Create a Pattern with Illustration Conversion

1 Touch Image .

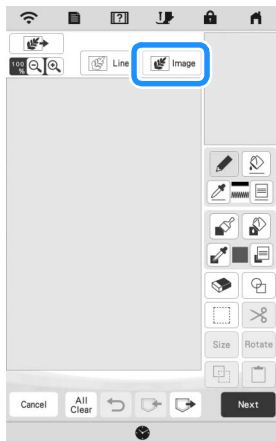

→ The image display screen appears.

2 Select the device you saved the data to.



3 Select the data, and then touch .



4 When loading is finished, specify the necessary settings in the loaded image confirmation screen.

Change the settings to adjust the image so it can easily be converted to the desired pattern.

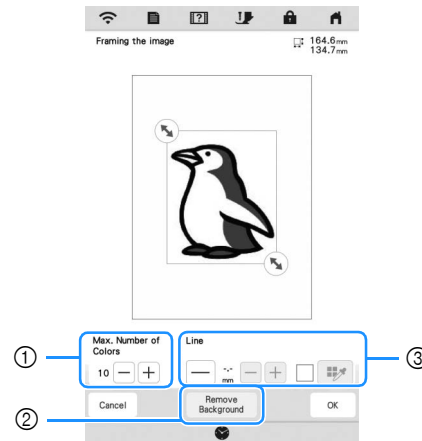



①	[Max. Number of Colors]	The number of colors in an image will be reduced less than the number specified here, and then the outline will be extracted.
②	[Remove Background]	Select whether or not the background color will be included as one of the colors.
③	[Line]	Select whether or not the outline will be detected as a line. A thick outline can also be detected as a region. When detected as a line, the line thickness and color can be specified.

* To stop loading and return to the screen in step 2, touch .

Memo

- Touch  to detect the outline.
Line thickness can be specified from 1.0 mm (approx. 1/16 inch) to 5.0 mm (approx. 3/16 inch).



- Touch  to select the outline color. Select by touching the color, or moving  icon using



in the color selection screen.





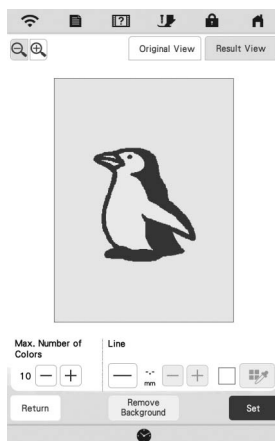

- 5 Move  to frame the image for the pattern.

- 6 Touch .

→ The screen for confirming the converted image appears.

- 7 In the screen for confirming the converted image, adjust the image as necessary as in step 4.





- *  : Enlarge the image.
 - *  : Display the image before being converted. Compare the images before and after being converted, and then change the settings if necessary.
 - *  : Return to the previous screen.
- After changes to the settings described above have been applied,  changes to . Touch  to check that the image is as desired.

- 8 Touch .

→ The pattern drawing screen appears.

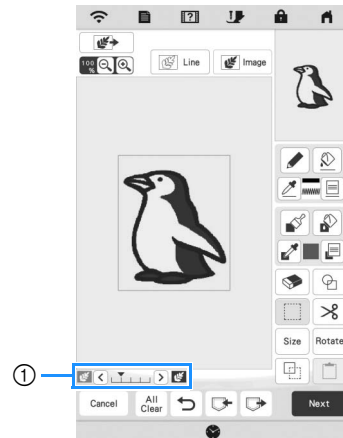
- 9 If necessary, edit the loaded image.



- * After the loaded image is converted to stitching, it appears as a background in the pattern drawing screen. Use gauge ① to adjust the transparency of the background. Each touch of  lightens the background, making the illustration pattern darker. Each touch of  darkens the background, making the illustration pattern lighter.

STIPLING

Basic Stippling with My Design Center

Create a stippling design with the basic procedure.

Example:



Note

- You can load a line drawing to create a stippling stitch or use image design function of a fabric pattern and incorporate the stippling stitch.

1 Touch  .

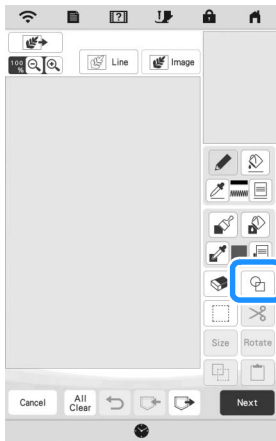

2 Select the square shape, and then touch .

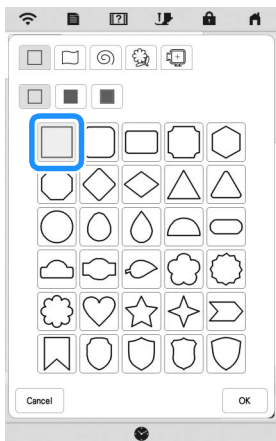

3 Touch  .

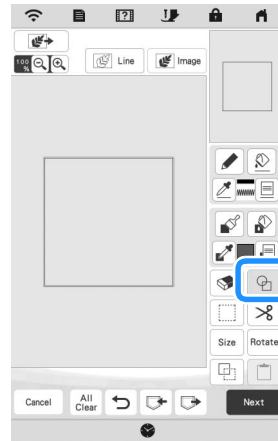

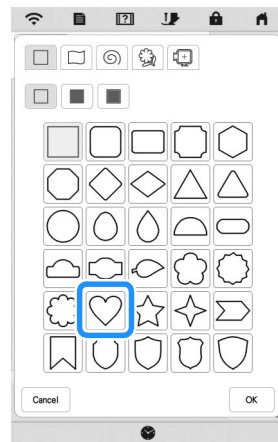

4 Select the heart shape, and then touch .



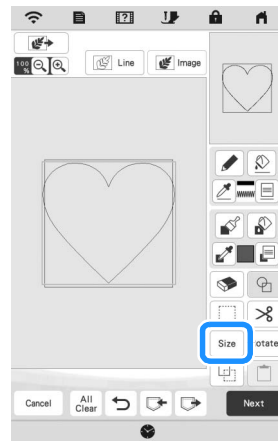

5 Touch .

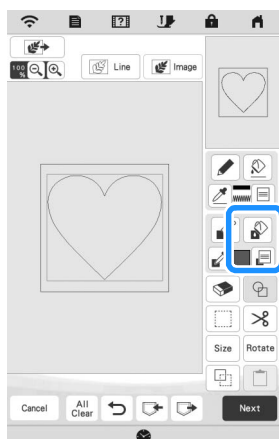

6 Touch  until the heart shape fits in the square shape, and then touch .

7 Touch , and then touch .



8 Touch , and then select the stitch color. Touch after setting the color.

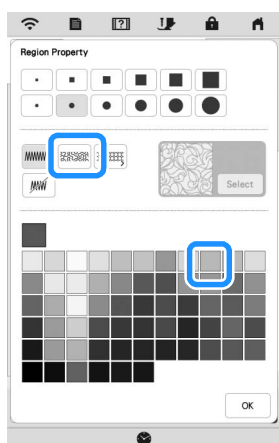

9 Select the region you want to set stippling effect.

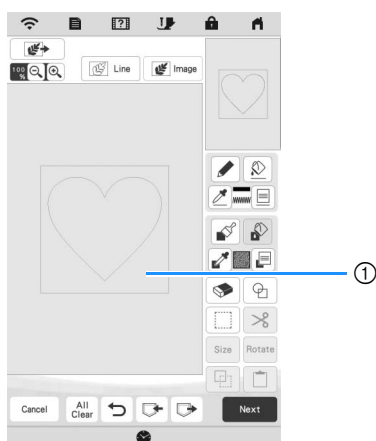

① Select this region.

10 Touch .

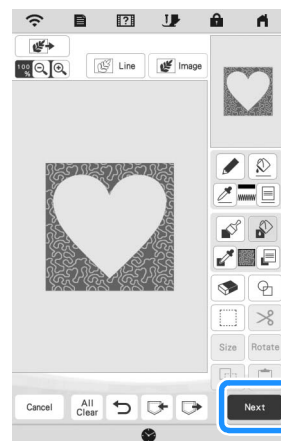

11 Adjust the stippling stitch settings to create the desired effect, and then touch .

* For details, refer to "Specifying Individual Stitch Settings" on page 167.

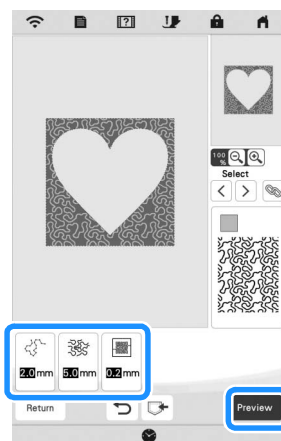

→ When the following message appears, touch .

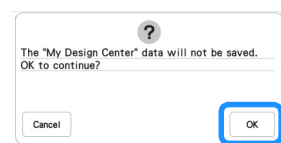

12 Touch **Set** to convert into embroidery.

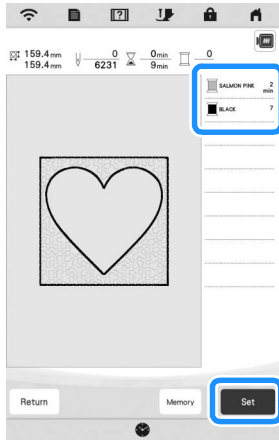

→ When the following message appears, touch **OK**.

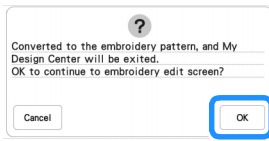



13 Follow the procedure described on “EDITING PATTERNS” on page 111 to edit the pattern as desired.

Decorative Stitching around a Pattern in Embroidery (a Quilting Function)

Memo

- For best results, reduce the embroidery speed. (page 22)
- For best results, hoop the stabilizer and fabric and embroider the design prior to adding the batting and backing under the hoop for quilting.

A quilt can be created with stippling stitch around an embroidery pattern.

1 Touch  in the home page screen and select the pattern that decorative stitching will be added around, and then touch  in the embroidery edit screen.

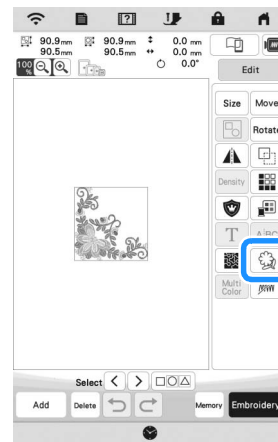

→ The outline of the pattern is displayed.



2 Set the distance and touch **Memory**.



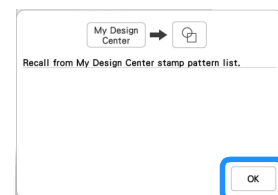

→ A message appears, and the pattern outline is registered as a stamp shape in My Design Center.

Touch **OK**.



- 3 Touch **Embroidery** to continue to the embroidery screen, and then embroider the pattern at the center.
- 4 Remove the embroidery frame from the carriage.
- 5 Photograph the embroidery frame with the application.
- 6 Attach the embroidery frame to the carriage again.
- 7 Place the batting and bottom layer of fabric under the embroidery frame.
- 8 Touch  in the home page screen to start My Design Center.
- 9 Touch  to load the embroidered fabric. Refer to "Loading the Background Image" on page 169 for details.



- 10 Touch , touch  to recall the stamp shape registered in step 2, and then arrange it over the loaded pattern.



- 11 Use a stamp or rectangular frame to determine the region to be stitched.

Note

- If the region is to be drawn by hand, be sure to draw a completely closed shape. If the region is not closed, it will not be correctly closed with any of the fill stitches.

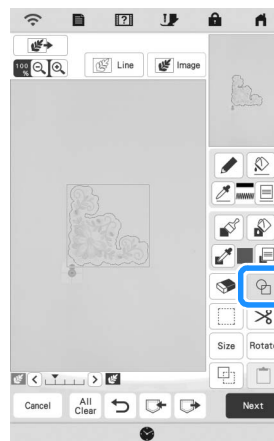





- 12 Touch  to select the pattern and color of the decorative stitching.

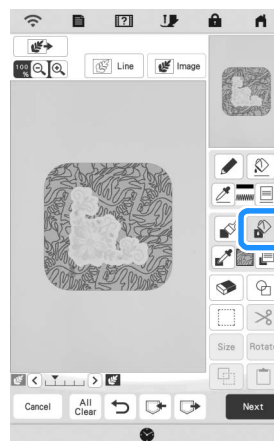

- 13 Touch , and then fill the region to be stitched outside of the stamp shape outline.





14 If you select the stamp shapes to determine the region on step **11**, touch  for the line tool keys to select . Touch , then select the frame outline, and then touch .

* Stitch settings can be adjusted in the stitch settings screen. For details, refer to “STITCH SETTINGS SCREEN” on page 167.

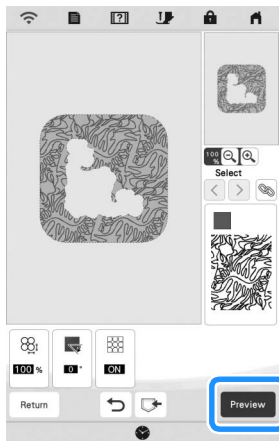

15 Specify the stitch spacing and length in the stitch settings screen, and then touch .



→ Check the pattern, and then touch .



16 Embroider the stippling stitch around the embroidery pattern.

MY STITCH MONITOR APP

With the My Stitch Monitor App installed on your smart device and the machine and smart device connected to the same wireless network, you can check the operating status of the machine. In addition, you can receive notifications when the machine stops.

■ Installing the App

1 Use your smart device to scan the appropriate QR code below to visit Google Play™ or the App Store.



Android™: <https://s.brother/msmagi>



iOS: <https://s.brother/msmggi>

2 Install [My Stitch Monitor].



My Stitch Monitor

Memo

- To download and install the app, you can also search for [My Stitch Monitor] in Google Play™ or the App Store.
- For more information on how to use this application, visit the following web site. <https://s.brother/cpeae/>

■ Monitoring

Memo

- The app will be updated from time to time. The following descriptions may differ from the actual screens and operations.

- 1 **Connect the machine to your wireless network.**
 - * Refer to "WIRELESS NETWORK CONNECTION FUNCTIONS" on page 27.
 - 2 **Confirm that your smart device and your machine are connected to the same network.**
 - 3 **Tap the icon for [My Stitch Monitor] on the smart device to start the app.**
 - 4 **Follow the instructions that appear in the app to connect the app to your machine.**
 - * Select the name that appears beside [Machine name] in the settings screen on your machine.
- The machine can now be monitored.

MY DESIGN SNAP APP

With My Design Snap app, you can position your embroidery designs on the fabric, by capturing image of the hooped fabric and sending the image to your machine.

■ Installing the My Design Snap App

- 1 **Use your smart device to scan the appropriate QR code below to visit Google Play™ or the App Store.**



Android™: <https://s.brother/mdsgfi>



iOS: <https://s.brother/mdsafi>

- 2 **Install [My Design Snap].**



My Design Snap

Memo

- To download and install the app, you can also search for [My Design Snap] in Google Play™ or the App Store.
- For more information on how to use this application, visit the following web site.
<https://s.brother/cpeae/>

ARTSPIRA APP COMPATIBLE

Functions have been added for the Artspira App. With these functions, you can transfer content published on the app to the embroidery machine and enjoy creating original works using the functions on the app.

For more information about the app, refer to the official website. For details on how to operate the embroidery machine using the app, see the Artspira Quick Guide on Artspira support page (<https://s.brother/csyai/>).

Chapter 7 APPENDIX

CARE AND MAINTENANCE

⚠ CAUTION

- Be sure to unplug the machine before cleaning it. Otherwise, injury may result.

Cleaning the LCD

If the surface of the LCD is dirty, lightly wipe it with a soft dry cloth.

Cleaning the machine surface

When wiping dirt off the machine, firmly wring a soft cloth soaked in (lukewarm) water.

After cleaning the machine, dry it with a soft, dry cloth.

Restrictions on Oiling

In order to prevent damaging this machine, it must not be oiled by the user. This machine was manufactured with the necessary amount of oil applied to ensure correct operation, making periodic oiling unnecessary.

If problems occur, such as difficulty turning the handwheel or an unusual noise, immediately stop using the machine, and contact your authorized Brother dealer or the nearest Brother authorized service center.

Precautions on Storing the Machine

Do not store the machine in any of the locations described below, otherwise damage to the machine may result, for example, rust caused by condensation.

- * Exposed to extremely high temperatures
- * Exposed to extremely low temperatures
- * Exposed to extreme temperature changes
- * Exposed to high humidity or steam
- * Near a flame, heater or air conditioner
- * Outdoors or exposed to direct sunlight
- * Exposed to extremely dusty or oily environments

💡 Note

- In order to extend the life of this machine, periodically turn it on and use it. Storing this machine for an extended period of time without using it may reduce its efficiency.

Cleaning the Race

- 1 Press  (Needle position button) to raise the needle.
- 2 Turn the main power to OFF, and then unplug the machine.
- 3 Remove the needle and presser foot (page 42, page 45).
- 4 Remove the flat bed attachment or the embroidery unit if either is attached.
- 5 Insert the multi-purpose screwdriver into the hole, and tilt the multi-purpose screwdriver to the left and then to the back, as shown in the illustration.

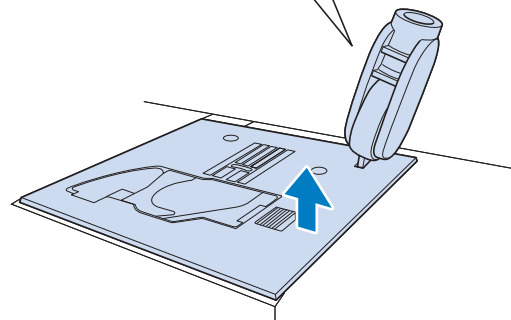
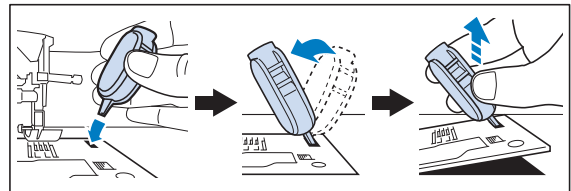

- 6 Slide out the needle plate with your right hand to remove it.

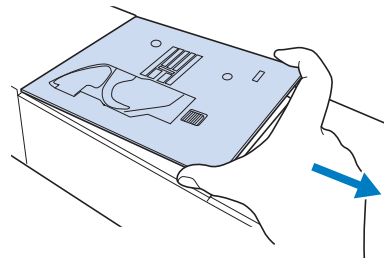

- 7 Grasp the bobbin case, and then gently lift out.

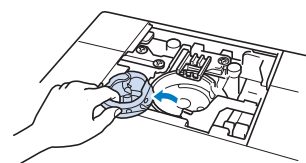

- 8** Use the cleaning brush or a vacuum cleaner to remove any lint and dust from the race and bobbin thread sensor and the surrounding area.

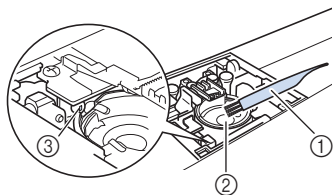

- ① Cleaning brush
- ② Race
- ③ Bobbin thread sensor

IMPORTANT

- Do not apply oil to the bobbin case.

Memo

- If lint or dust collects on the bobbin thread sensor, the sensor may not operate correctly.

- 9** Insert the bobbin case so that the ▲ mark on the bobbin case aligns with the ● mark on the machine.

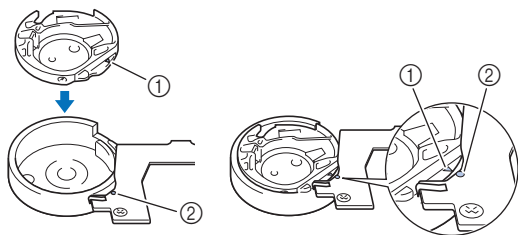

- * Align the ▲ and ● marks.

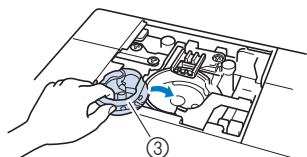

- ① ▲ mark
- ② ● mark
- ③ Bobbin case

- * Make sure that the indicated points are aligned before installing the bobbin case.

CAUTION

- Never use a bobbin case that is scratched or has a burr on it. Otherwise the upper thread may become tangled, and the needle may break and cause injury. For a new bobbin case, contact your nearest Brother authorized service center.
- Be sure that the bobbin case is correctly installed, otherwise the needle may break and cause injury.

- 10** Insert the tabs on the needle plate into the notches in the machine.

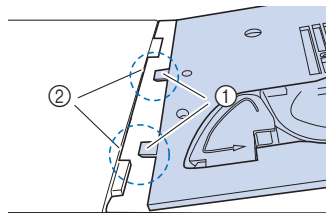

- ① Tabs
- ② Notches

- 11** Press down on the right side of the needle plate to secure it.

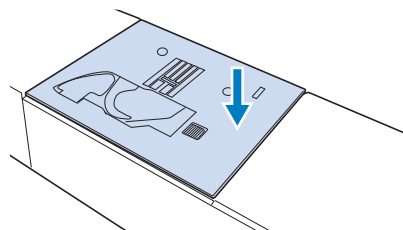

Cleaning the Cutter in the Bobbin Case Area

The cutter below the needle plate should be cleaned. If dust or lint accumulate on the cutter, it will be difficult to cut the thread when  (Thread cutter button) is pressed or the automatic thread cutting function is used. Clean the cutter when the thread is not easily cut.

- 1** Follow steps 1 through 7 in “Cleaning the Race” to remove the needle plate and the bobbin case.
- 2** Use the cleaning brush or a vacuum cleaner to remove any lint and dust from the cutter in the bobbin case area.

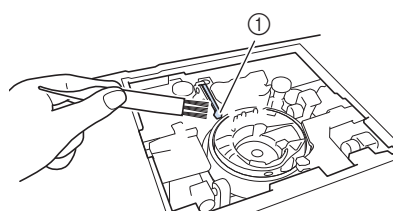

- ① Cutter

CAUTION

- Do not touch the cutter, otherwise injuries may result.

- 3** Insert the bobbin case and attach the needle plate following steps 9 through 11 in “Cleaning the Race”.



Note

- If the needle plate has been removed, check machine operations to confirm that installation has been completed correctly. Refer to “Checking Machine Operations” on page 186.

BEFORE LENDING OR DISPOSING OF THE PRODUCT

Please be sure to reset the settings of your machine to delete the following data.

- all saved data
- customized settings
- network information

1 Touch , and then touch  beside [Reset to Default].

2 Touch .

Note

- Do not turn the main power to OFF while the [Deleting...] screen is displayed.

ADJUSTING THE SCREEN

Touch Panel is Malfunctioning

If the screen does not respond correctly when you touch a key (the machine does not perform the operation or performs a different operation), follow the steps below to make the proper adjustments.

1 Holding your finger on the screen, turn the main power switch to OFF and back to ON.



→ The touch panel adjustment screen appears.

2 Using the included touch pen, lightly touch the center of each +, in order from 1 to 13.

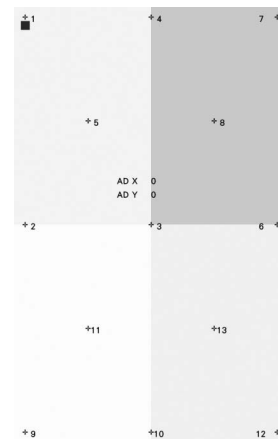

Note

- Only use the included touch pen to touch the screen. Do not use a mechanical pencil, pin, or other sharp object. Do not press too hard on the screen. Otherwise, damage may result.

3 Turn the main power to OFF, then turn it back to ON.

Note

- If you finish the screen adjustment and the screen still does not respond, or if you cannot do the adjustment, contact your authorized Brother dealer.

TROUBLESHOOTING

If the machine stops operating correctly, check the following possible problems before requesting service. You can solve most problems by yourself. If you need additional help, the Brother Support website offers the latest FAQs and troubleshooting tips.

Visit us at <https://s.brother/cpeae/>.

If the problem persists, contact your authorized Brother dealer or the nearest Brother authorized service center.

Frequent Troubleshooting Topics

Detailed causes and remedies for common troubleshooting topics are described below. Be sure to refer to this before contacting your authorized Brother dealer.

■ Upper Thread is Too Tight	page 184
■ Tangled Thread on Wrong Side of Fabric	page 184
■ Incorrect Thread Tension	page 185
■ Fabric is Caught in the Machine and Cannot Be Removed	page 185
■ If the Thread Becomes Tangled Under the Bobbin Winder Seat	page 186

Upper Thread is Too Tight

■ Symptom

- * The upper thread appears as a single continuous line.
- * The bobbin thread is visible from the right side of the fabric. (Refer to the illustration below.)
- * The upper thread has tightened up, and comes out when pulled.
- * The upper thread has tightened up, and wrinkles appear in the fabric.
- * The upper thread tension is tight, and the results do not change even after the thread tension is adjusted.

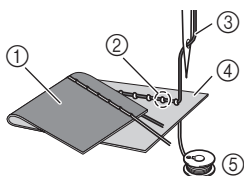

- ① Wrong side of fabric
- ② Bobbin thread visible from right side of fabric
- ③ Upper thread
- ④ Right side of fabric
- ⑤ Bobbin thread

■ Cause

Incorrect bobbin threading

If the bobbin thread is incorrectly threaded, instead of the appropriate tension being applied to the bobbin thread, it is pulled through the fabric when the upper thread is pulled up. For this reason, the thread is visible from the right side of the fabric.

■ Remedy

Correctly install the bobbin thread. (page 34)

Tangled Thread on Wrong Side of Fabric

■ Symptom

- * The thread becomes tangled on the wrong side of the fabric.

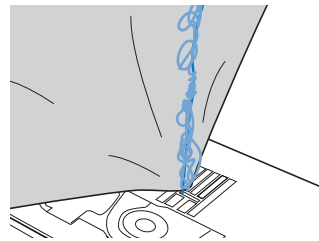

- * After starting sewing, a rattling noise is made and sewing cannot continue.
- * Looking under the fabric, there is tangled thread in the bobbin case.

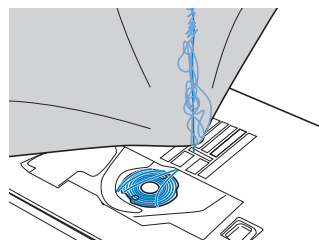

■ Cause

Incorrect upper threading

If the upper thread is incorrectly threaded, the upper thread passed through the fabric cannot be firmly pulled up and the upper thread becomes tangled in the bobbin case, causing a rattling noise.

■ Remedy

Remove the tangled thread, and then correct the upper threading.

1 Remove the tangled thread. If it cannot be removed, cut the thread with scissors.

- * Refer to "Cleaning the Race" on page 181.

2 Remove the upper thread from the machine.

3 Correct the upper threading by following the instructions in "Upper Threading" on page 36.

- * If the bobbin was removed from the bobbin case, refer to "Setting the Bobbin" on page 34 to correctly install the bobbin.

Incorrect Thread Tension

Symptoms

- Symptom 1: The bobbin thread is visible from the right side of the fabric.
- Symptom 2: The upper thread appears as a straight line on the right side of the fabric.
- Symptom 3: The upper thread is visible from the wrong side of the fabric.
- Symptom 4: The bobbin thread appears as a straight line on the wrong side of the fabric.
- Symptom 5: The stitching on the wrong side of the fabric is loose or has slack.

 Symptom 1

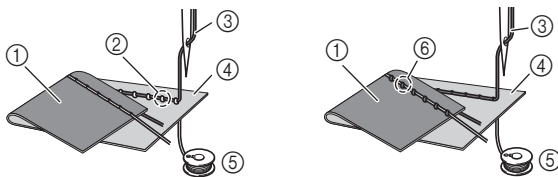
 Symptom 3

- ① Wrong side of fabric
- ② Bobbin thread visible on right side of fabric
- ③ Upper thread
- ④ Right side of fabric
- ⑤ Bobbin thread
- ⑥ Upper thread visible from wrong side of fabric

Cause/Remedy

 Cause 1

The machine is not correctly threaded.

<With symptoms 1 and 2 described above>

The bobbin threading is incorrect.

Return the upper thread tension to the standard setting, and then refer to "Setting the Bobbin" on page 34 to correct lower threading.

<With symptoms 3 through 5 described above>

The upper threading is incorrect.

Return the upper thread tension to the standard setting, and then refer to "UPPER THREADING" on page 36 to correct the upper threading.

 Cause 2

A needle and thread appropriate for the fabric are not being used.

The machine needle that should be used depends on the type of fabric sewn and the thread thickness.

If a needle and thread appropriate for the fabric are not being used, the thread tension will not be adjusted correctly, causing wrinkles in the fabric or skipped stitches.

- * Refer to "FABRIC/THREAD/NEEDLE COMBINATIONS" on page 44 to check that a needle and thread appropriate for the fabric are being used.

 Cause 3

An appropriate upper tension is not selected.

Select an appropriate thread tension. Refer to "Setting the Thread Tension" on page 58.

The appropriate thread tension differs according to the type of fabric and thread being used.

- * Adjust the thread tension while test sewing on a piece of scrap fabric that is the same as that used in your project.

Note

- If the upper threading and bobbin threading are incorrect, the thread tension cannot be adjusted correctly. Check the upper threading and bobbin threading first, and then adjust the thread tension.

* When the bobbin thread is visible on the right side of the fabric.

Set the upper thread tension to a lower number. (Loosen the thread tension.)

* When the upper thread is visible on the wrong side of the fabric.

Set the upper thread tension to a higher number. (Tighten the thread tension.)



Fabric is Caught in the Machine and Cannot Be Removed

If the fabric is caught in the machine and cannot be removed, the thread may have become tangled under the needle plate. Follow the procedure described below to remove the fabric from the machine. If the operation cannot be completed according to the procedure, instead of attempting to complete it forcefully, contact your nearest Brother authorized service center.

Removing the Fabric From the Machine

1 Immediately stop the machine.

2 Turn off the machine.

3 Remove the needle.

If the needle is lowered into the fabric, turn the handwheel away from you (clockwise) to raise the needle out of the fabric, and then remove the needle.

- * Refer to "CHANGING THE NEEDLE" on page 42.

4 Remove the presser foot.

If the thread is entangled on the presser foot, remove the entangled thread, and then raise the presser foot lever to remove the presser foot. Otherwise, the presser foot may be damaged.

- * Refer to "CHANGING THE PRESSER FOOT" on page 45.

5 Lift up the fabric and cut the threads below it.

If the fabric can be removed, remove it. Continue with the following steps to clean the race.

6 Remove the needle plate and bobbin case.

If threads remain in the bobbin case, remove them.

- * Refer to "Cleaning the Race" on page 181.

7 Remove any threads in the race and around the feed dogs.

* Refer to step **8** on page 182.

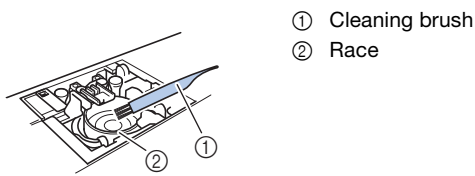

8 Insert the bobbin case and then attach the needle plate.

* Refer to steps **9** through **11** on page 182.

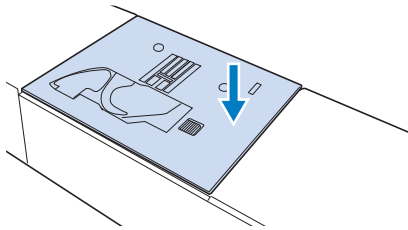

9 Check the condition of the needle, and then install it.

If the needle is in a poor condition, for example, if it is bent, be sure to install a new needle.

* Refer to "CHANGING THE NEEDLE" on page 42.

Checking Machine Operations

If the needle plate has been removed, check machine operations to confirm that installation has been completed correctly.

1 Turn on the machine.

2 Select Straight stitch (Middle).

Note

- Do not yet install the presser foot and thread.

3 Slowly turn the handwheel toward you (counterclockwise), and look from all sides to check that the needle falls at the center of the opening in the needle plate.

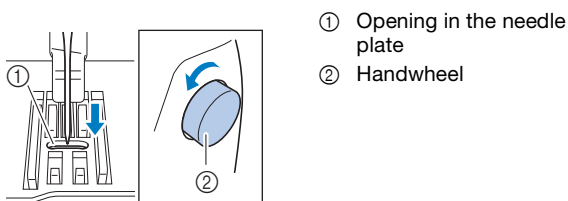

If the needle or feed dogs contact the needle plate, the machine may be malfunctioning; therefore, contact your authorized Brother dealer or the nearest Brother authorized service center.

4 Turn off the machine, and then install the bobbin and presser foot.

Never use a scratched or damaged presser foot. Otherwise, the needle may break, or sewing performance may suffer.

* Refer to "Setting the Bobbin" on page 34 and "CHANGING THE PRESSER FOOT" on page 45.

5 Correctly thread the machine.

* For details on the machine, refer to "UPPER THREADING" on page 36.

Note

- The thread may have become tangled as a result of incorrect upper threading. Make sure that the machine is correctly threaded.

6 Perform trial sewing with normal fabric.

Note

- Incorrect sewing may be the result of incorrect upper threading or sewing thin fabrics. If there are poor results from the trial sewing, check the upper threading or the type of fabric being used.

If the Thread Becomes Tangled Under the Bobbin Winder Seat

If the bobbin winding starts when the thread is not passed through the pretension disk correctly, the thread may become tangled beneath the bobbin winder seat.

Wind off the thread according to the following procedure.

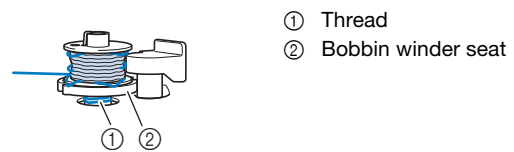

CAUTION

- Do not remove the bobbin winder seat even if the thread becomes tangled under the bobbin winder seat. The cutter in the bobbin winder seat may cause injury.

1 Touch to stop the bobbin winding.

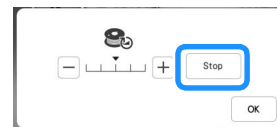

2 Cut the thread with scissors near the pretension disk.

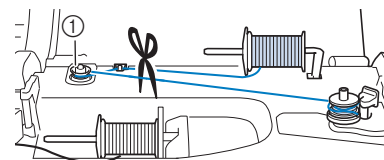

① Pretension disk

- 3 Push the bobbin winder switch to the right, and then remove the bobbin from the shaft and cut the thread leading to the bobbin in order to be able to completely remove the bobbin from shaft.

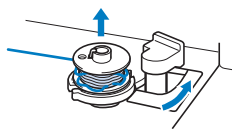

- 4 Hold the thread end with your left hand, and wind off the thread clockwise from under the bobbin winder seat with your right hand as shown below.

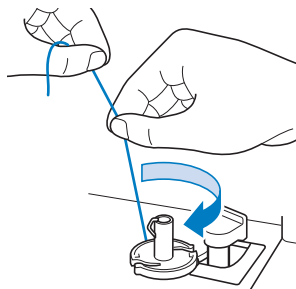



List of Symptoms

Check the following possible problems before requesting service. If the reference page is “*”, contact your authorized Brother dealer or the nearest Brother authorized service center.

■ Getting Ready

Symptom, Cause/solution	Reference
Cannot thread the needle.	
Needle is not in the correct position. • Press  (Needle position button) to raise the needle.	10
Needle is installed incorrectly.	42
Needle is turned, bent or the point is dull.	42
Upper threading is incorrect.	36
The needle threader hook is bent and does not pass through the eye of the needle.	*
The needle threader lever cannot be moved or returned to its original position.	*
A size 65/9 needle is being used. • The needle is incompatible with the needle threader. Manually pass the thread through the eye of the needle.	38

Cannot lower the presser foot with the presser foot lever.

Presser foot was raised using  (Presser foot lifter button). • Press  (Presser foot lifter button) to lower the presser foot.	10
---	----

Bobbin thread does not wind neatly on the bobbin.

The thread is not passed through the bobbin winding thread guide correctly.	31
Bobbin spins slowly.	32
The thread that was pulled out was not wound onto the bobbin correctly.	32
The empty bobbin was not set on the pin properly.	30

While winding the bobbin, the bobbin thread was wound below the bobbin winder seat.



You have not wound the bobbin thread properly when you initially wound thread on the bobbin. Ensure that the bobbin thread was properly set in the guides.	30
--	----

Symptom, Cause/solution	Reference
The bobbin thread cannot be pulled up.	
Needle is turned, bent or the point is dull.	42
Bobbin is set incorrectly.	34

Machine does not operate	
All keys and buttons have been locked by  .	42, 45

Nothing appears in the LCD.	
Main power switch is not turned on.	14
The plug of the power cord is not inserted into an electrical outlet.	14

The LCD screen does not look very clear.	
The brightness of the screen is not adjusted.	21

Nothing happens, even if the LCD display is touched	
Adjust the screen.	183
The screen has been locked. <ul style="list-style-type: none"> Touch either of the following keys to unlock the screen.   	—

The LCD screen is fogged up.	
Condensation has formed on the LCD screen. <ul style="list-style-type: none"> After a while, the cloudiness will disappear. 	—

Embroidery unit does not operate.	
Embroidery unit is not attached correctly.	104
Embroidery frame was attached before the unit was initialized.	104

Pointer of the embroidery foot “W+” with LED pointer does not indicate the position correctly	
With thick elastic fabric, the position will be misaligned only at raised parts in the fabric.	130
With fabric having a very uneven surface, the position is not correctly aligned. <ul style="list-style-type: none"> The pointer indication should be used only as a reference. 	—

■ While Operating

Symptom, Cause/solution	Reference
Machine does not operate.	
“Start/Stop” button was not pressed.	10
There is no stitch pattern selected.	49
Presser foot is not lowered.	10
“Start/Stop” button was pressed with the foot controller attached.	51
The “Start/Stop” button was pressed while the machine is set for the sewing speed controller to control the zigzag stitch width.	20, 51

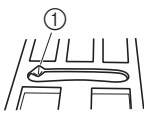
Needle breaks.	
Needle is installed incorrectly.	42
Needle clamp screw is not tightened.	43
Needle is turned or bent.	42
Using improper needle or thread for the selected fabric.	44
Wrong presser foot was used.	197
Upper thread tension is too tight.	58, 147
Fabric is pulled during sewing.	—
Spool cap is set incorrectly.	36
There are scratches around the opening in the needle plate. <ul style="list-style-type: none"> * There is a notch on the left side of the opening in the needle plate. This is not a scratch. 	*
 <p>① Notch</p>	
There are scratches around the opening in the presser foot.	*
There are scratches on the bobbin case.	*
Needle is defective.	42
A bobbin designed specifically for this machine is not used.	30
Upper threading is incorrect.	36
Bobbin is set incorrectly.	34
Presser foot is attached incorrectly.	45
Screw of the presser foot holder is loose.	45
Fabric is too thick.	65
Fabric is fed forcefully when sewing thick fabric or thick seams.	65
Stitch length is too short.	58

Symptom, Cause/solution	Reference
Stabilizer is not attached to fabric being embroidered.	126
Bobbin thread is incorrectly wound.	30

Upper thread breaks.

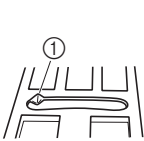
Machine is not threaded correctly (used the wrong spool cap, spool cap is loose, the thread did not catch the needle bar threader, etc.)	36
Knotted or tangled thread is being used.	—
The selected needle is not appropriate for the thread being used.	44
Upper thread tension is too tight.	58, 147
Thread is twisted.	—
Needle is turned, bent or the point is dull.	42
Needle is installed incorrectly.	42
There are scratches around the opening of the needle plate. * There is a notch on the left side of the opening in the needle plate. This is not a scratch.	*
 ① Notch	
There are scratches around the opening in the presser foot.	*
There are scratches on the bobbin case.	*
Using improper needle or thread for the selected fabric.	44
A bobbin designed specifically for this machine is not used.	30

The thread is tangled on the wrong side of the fabric.

Upper threading is incorrect.	36
Using improper needle or thread for the selected fabric.	44

The upper thread is too tight.

The bobbin thread is incorrectly installed.	34
---	----

Bobbin thread breaks.

Bobbin is set incorrectly.	34
Bobbin thread is incorrectly wound.	30
There are scratches on the bobbin or it doesn't rotate properly.	34
Thread is twisted.	—

Symptom, Cause/solution	Reference
A bobbin designed specifically for this machine is not used.	30

Fabric puckers.

There is a mistake in the upper or bobbin threading.	34, 36
Spool cap is set incorrectly.	36
Using improper needle or thread for the selected fabric.	44
Needle is turned, bent or the point is dull.	42
Stitches are too long when sewing thin fabrics.	58
Thread tension is set incorrectly.	58, 147
Wrong presser foot was used.	197

The stitch is not sewn correctly.

The presser foot that is used is not appropriate for the type of stitch that you wish to sew.	197
The thread tension is incorrect.	58
The thread is tangled, for example, in the bobbin case.	181

Skipped stitches

Machine is threaded incorrectly.	36
Using improper needle or thread for the selected fabric.	44
Needle is turned, bent or the point is dull.	42
Needle is installed incorrectly.	42
Needle is defective.	42
Dust or lint has collected under the needle plate.	181
Thin or stretch fabrics are being sewn.	66

No stitching

Needle is turned, bent or the point is dull.	42
Bobbin is set incorrectly.	34
Upper threading is incorrect.	36

High-pitched sound while sewing

Dust or lint is caught in the feed dogs.	181
Pieces of thread are caught in the race.	181
Upper threading is incorrect.	36
A bobbin designed specifically for this machine is not used.	30
There are needle holes or friction scratches in the bobbin case.	181

Symptom, Cause/solution	Reference
Fabric does not feed through the machine.	
Feed dogs are set in the down position. <ul style="list-style-type: none"> • Touch , and then turn the handwheel to raise the feed dogs. 	76
Stitches are too close together.	58
Wrong presser foot was used.	197
Needle is turned, bent or the point is dull.	42
Thread is entangled.	185
Zigzag foot “J” is slanted on a thick seam at the beginning of stitching.	65

The fabric feeds in the opposite direction.	
The feed mechanism is damaged.	*

The needle contacts the needle plate.	
The needle clamp screw is loose.	42
Needle is turned, bent or the point is dull.	42

Fabric being sewn with the machine cannot be removed.	
Thread is tangled below the needle plate.	184

A broken needle has fallen into the machine.	
<ul style="list-style-type: none"> • Turn off the machine, and then remove the needle plate. If the needle that fell into the machine can be seen, use tweezers to remove it. After removing the needle, return the needle plate to its original position. Before turning on the machine, slowly turn the handwheel toward you to check that it turns smoothly. If the handwheel does not turn smoothly or the needle that fell into the machine cannot be removed, consult your authorized Brother dealer. 	185

The handwheel feels sluggish when it is turned.	
Thread is tangled in the bobbin case.	184

■ After Sewing

Symptom, Cause/solution	Reference
Thread tension is incorrect.	
Upper threading is incorrect.	36
Bobbin is set incorrectly.	34
Using improper needle or thread for the selected fabric.	44
Presser foot holder is not attached correctly.	45
Thread tension is set incorrectly.	58, 147
Bobbin thread is incorrectly wound.	30
Needle is turned, bent or the point is dull.	42
A bobbin designed specifically for this machine is not being used.	30

Character or decorative stitch patterns are misaligned.	
Stitch pattern adjustment settings were set incorrectly.	95



Stitch pattern does not turn out.	
Wrong presser foot was used.	197
Did not use a stabilizer material on thin fabrics or stretch fabrics.	66
Thread tension is set incorrectly.	58, 147
Fabric was pulled, pushed or fed at an angle while it was being sewn. <ul style="list-style-type: none"> • Sew while guiding the fabric with your hands so that the fabric is fed in a straight line. 	49
The thread is tangled, for example, in the bobbin case.	184

Symptom, Cause/solution	Reference
The pattern is not embroidered correctly.	
Thread is twisted.	—
Thread tension is set incorrectly.	58, 147
Fabric was not inserted into the frame correctly (fabric was loose, etc.).	127
Stabilizing material was not attached. <ul style="list-style-type: none"> Always use stabilizing material, especially with stretch fabrics, lightweight fabrics, fabrics with a coarse weave, or fabrics that often cause pattern shrinkage. See your authorized Brother dealer for the proper stabilizer. 	126
There was an object placed near the machine, and the carriage or embroidery frame hit the object during embroidering.	104
Fabric outside the frame edges interferes with the arm, so the embroidery unit cannot move. <ul style="list-style-type: none"> Reinsert the fabric in the embroidery frame so that the excess fabric is away from the arm, and rotate the pattern 180 degrees. 	127
Fabric is too heavy, so the embroidery unit cannot move freely. <ul style="list-style-type: none"> Place a large thick book or similar object under the arm head to lightly lift the heavy side and keep it level. 	—
Fabric is hanging off the table. <ul style="list-style-type: none"> If the fabric is hanging off the table during embroidery, the embroidery unit will not move freely. Place the fabric so that it does not hang off the table or hold the fabric to keep it from dragging. 	138
Fabric is snagged or caught on something. <ul style="list-style-type: none"> Stop the machine and place the fabric so that it does not get caught or snagged. 	—
Embroidery frame was removed during embroidering (for example, to reset the bobbin). The presser foot was bumped or moved while removing or attaching the embroidery frame, or the embroidery unit was moved.	141
Stabilizer is incorrectly attached, for example, it is smaller than the embroidery frame.	126
Loops appear on the surface of the fabric when embroidering	
The thread tension is incorrectly set.	147
The tension of the upper thread is incorrectly set for the combination of the fabric, thread and pattern being used. <ul style="list-style-type: none"> Use the embroidery needle plate cover. 	138
The combination of the bobbin case and bobbin thread is incorrect.	137

ERROR MESSAGES

Below is an explanation of error messages. Refer to these when necessary (if you touch  or do the operation correctly while the error message is displayed, the message disappears).

	Error messages	Cause/solution
1	Cannot change the configuration of the characters.	This message is displayed when there are too many characters and the curved character configuration is impossible.
2	Cannot recognize the data for the selected pattern. The data may be corrupted.	This message is displayed when there is a possibility that the data for the selected embroidery pattern is corrupted.
3	Change to a larger embroidery frame.	This message is displayed when the machine is in embroidery mode and the small frame is attached, and the selected pattern does not fit in the small frame.
4	Data volume is too large for this pattern.	This message is displayed when the stitch patterns you are editing take up too much memory, or if you are editing too many stitch patterns for the memory. For a combined pattern, reduce the number of patterns.
5	Failed to save file.	This message is displayed when no more images can be saved on the USB media. In this case, delete a file from the USB media or use different USB media.
6	Includes a special pattern that cannot be saved to external memory. Save the pattern in the machine's memory.	This message is displayed when you try to save a copyright protected pattern to USB media. According to copyright laws, patterns that are illegal to reproduce or edit cannot be saved to USB media. If this message displays, save the pattern in the machine's memory.
7	Lower the presser foot lever.	This message is displayed when  (Presser foot lifter button) is pressed while the presser foot lever is raised and the needle is lowered.
8	Not enough available memory to save the data. Delete some patterns or use a different media.	This message is displayed when the memory is full and the stitch pattern or embroidery pattern cannot be saved.
9	OK to recall and resume previous memory?	This message appears if the machine is turned off while embroidering, then turned on again. Touch  to return the machine to the condition (pattern position and number of stitches) when it was turned off. Follow the procedure described in "If the Thread Breaks or the Bobbin Runs out of Thread During Embroidering" on page 141 to align the needle position and embroider the remainder of the pattern.
10	OK to separate the combined border pattern?	This message is displayed when rotating a saved combined pattern in the embroidery screen.
11	Pattern extends to the outside of embroidery frame.	This message is displayed when the machine is in embroidery mode, and the character pattern combination is too large to fit in the embroidery frame.
12	Pattern extends to the outside of embroidery frame. If you plan to add more patterns, rotate the pattern combination.	This message is displayed when the machine is in embroidery mode and the combined character pattern is too large for the embroidery frame. You can rotate the pattern 90 degrees and continue combining characters.
13	Preventive maintenance is recommended.	This message is displayed when the machine needs to be maintained. Once this message appears, it is recommended to take your machine to an authorized Brother dealer or the nearest Brother authorized service center for a regular maintenance check. Although this message will disappear and the machine will continue to function once you touch  , the message will display several more times until the appropriate maintenance is performed.
14	Remove Dual Feed module from the machine.	This message appears when you try to start embroidering with the dual feed foot attached to the machine. Remove the dual feed foot before entering the embroidery mode.
15	Set the clock.	This message appears when the time/date is not set. Set time/date. (page 14)
16	The "Start/Stop" button does not operate with the foot controller attached. Remove the foot controller.	This message is displayed when the "Start/Stop" button is pushed to sew Utility stitches or Character/Decorative stitches while the foot controller is connected.

	Error messages	Cause/solution
17	The bobbin thread is almost empty.	This message is displayed when the bobbin thread is running out. Although a few stitches can be sewn when the "Start/Stop" button is pressed, replace with a wound bobbin immediately. When embroidering, touch  , touch  , remove the embroidery frame, and then replace the bobbin with one wound with plenty of embroidery bobbin thread. If [Upper and Bobbin Thread Sensor] in the general settings screen of the machine setting mode is set to [OFF], this message does not appear.
18	The bobbin winder safety device has activated. Is the thread tangled?	This message is displayed when the bobbin is being wound, and the motor locks because the thread is tangled, etc.
19	The safety device was activated since the main shaft motor was heated. Is the thread tangled?	This message is displayed when the temperature of the motor increases, activating the safety device. Wait until the temperature decreases. If the error persists, contact your nearest authorized Brother dealer.
20	The safety device was activated since the main shaft motor seized. Is the thread tangled?	This message is displayed when the motor locks due to tangled thread or for other reasons related to thread delivery.
21	The safety device was activated since the needle position sensor malfunctioned.	This message is displayed when an error in the needle position sensor is detected, activating the safety device. Turn the machine off, then on again. If the message continues to appear, the machine may be damaged. Contact your nearest authorized Brother dealer.
22	Turn off the machine before attaching or removing the needle plate.	This message is displayed when you try to sew with a stitch other than a middle needle position stitch while the straight stitch needle plate is installed. This message is displayed when the needle plate is removed with the machine on or when the machine is turned on and embroidery mode is selected.
23	This file cannot be used.	This message appears if the file format is incompatible with this machine. Check the list of compatible file formats. (page 194)
24	This file exceeds the data capacity and cannot be used. Use a suitable size file.	This message is displayed when the file size exceeds the data capacity of the machine. Confirm the file size and format. (page 194)
25	This key cannot be used at this time.	This message is displayed when you touch [Sewing Guide] in the screen other than the Utility Stitch, or touch [Pattern Explanation] in the screen other than the Utility Stitch or Character/Decorative Stitch.
26	This USB media cannot be used.	This message is displayed when you try to use incompatible media. For a list of compatible USB media, visit https://s.brother/cpeae/ .
27	Turn off the power and replace the needle plate.	<ul style="list-style-type: none"> This message is displayed when the machine is set to embroidery mode or utility decorative stitch mode from the home page screen while the straight stitch needle plate or no needle plate is installed. This message is displayed when the straight stitch needle plate is installed while a stitch pattern that cannot be used with that needle plate is selected.
28	USB media error	This message is displayed when an error occurs with the USB media. For a list of compatible USB media, visit https://s.brother/cpeae/ .
29	When the speed controller is set to control the zigzag stitch width, the "Start/Stop" button does not operate.	This message is displayed when the speed control lever is set to control the zigzag stitch width, and the "Start/ Stop" button is pressed. Set [Width Control] to [OFF] in the settings screen to use the "Start/Stop" button (page 20), or use the foot controller to operate the machine (page 75).

SPECIFICATIONS

Item	Specification		
Dimensions of machine	Approx. 662 mm (W) × 348 mm (H) × 321 mm (D) (approx. 26-1/16 inches (W) × 13-11/16 inches (H) × 12-5/8 inches (D))		
Weight of machine	Approx. 17 kg (approx. 37.5 lb)		
Dimensions of machine with embroidery unit attached	Approx. 916 mm (W) × 348 mm (H) × 524 mm (D) (approx. 36-1/16 inches (W) × 13-11/16 inches (H) × 20-5/8 inches (D))		
Weight of machine with embroidery unit attached	Approx. 20.7 kg (approx. 45.6 lb)		
Sewing speed	70 to 1050 stitches per minute		
Maximum embroidery speed	1050 stitches per minute		
Interfaces	Wireless LAN ^{*1}		
Memory	Stitch patterns	1 MB	
	Embroidery patterns	10 MB	
	My Design Center	100 MB	
Data Types	Stitch patterns ^{*2}	.pmv .pmx .pmu .pmi	
	Embroidery patterns ^{*3}	.pes .phc .phx .dst .pen	
	Data that can be loaded when using My Design Center	.jpg (up to 2 MB), .png (up to 2 MB), .bmp (up to 3 MB)	
Number of decorative stitch pattern combinations	Up to 70		
Maximum embroidering area	360 mm (H) × 240 mm (W) (approx. 14 inches (H) × 9-1/2 inches (W))		
Types of USB Devices/Media that can be Used ^{*4}	Stitch patterns, Embroidery patterns	Data can be saved to or recalled from USB media. Use media that meets the following specifications. • USB Flash drive (USB Flash memory) Embroidery data can be recalled only from; • USB External CD/DVD drives	
Condition of the [Eco Mode] and [Shutoff Support Mode]	[Eco Mode]	Available time	OFF, 10 - 120 (minute)
		"Start/Stop" button	Green flashing
		Suspended function	Machine light, Screen display, LED pointer, Guideline marker
		After recovering	The machine starts from the previous operation.
	[Shutoff Support Mode]	Available time	OFF, 1 - 12 (hour)
		"Start/Stop" button	Green slow flashing
		Suspended function	All functions
		After recovering	An error message appears. You need to turn off and on the machine to restart.
Compatible image files of the Screen Saver Image	Format	.jpg	
	File size	Max. 150 KB for each image	
	File dimension	1280 × 1280 pixels or less (If the width is between 800 and 1279 pixels, the image will be displayed at 800 pixels.)	
	Number allowed	5 or less	
Videos that can be played	MP4 file format	Video - H.264/MPEG-4 AVC, Audio - AAC	
	Size	450 (H) × 800 (W)	
	Maximum file size	1 GB	

^{*1} The wireless network connection complies with IEEE 802.11b/g/n standards and uses the 2.4 GHz frequency.

A wireless network cannot be set up with WPA™/WPA2™ Enterprise.

Use Design Database Transfer or PE-DESIGN version 11 or later to transfer data from your computer to the machine. For the operating systems compatible with the software, visit our website <https://s.brother/cnekd/>.

^{*2} ".pmu" stitch data files can be retrieved; however, when the machine is used to save the file, it is saved as a ".pmv" stitch data file. Using data other than that created using this machine or the machine which create ".pmu" data file, may cause the machine to malfunction.

^{*3} • Using data other than that saved using our data design systems or this machine may cause this machine to malfunction.

When the machine is used to save a file with any extension, it is saved as a .phx data file.

- Since Tajima (.dst) data does not contain specific thread color information, it is displayed with our default thread color sequence. Check the preview and change the thread colors as desired.

- *4 Some USB media may not be usable with this machine. Please visit our website <https://s.brother/cpeae/> for more details.
- * Please be aware that some specifications may change without notice.

Note

- We recommend using the 26 letters of the alphabet (uppercase and lowercase), the numbers 0 through 9, “-”, and “_” for the name of the file/folder.

IMPORTANT

- **When using embroidery data other than our original patterns, the thread or needle may break when embroidering with a stitch density that is too fine or when embroidering three or more overlapping stitches. In that case, use one of our original data design systems to edit the embroidery data.**

UPDATING YOUR MACHINE'S SOFTWARE

You can update your machine's software using the following two procedures.

Update Procedure Using USB Media

When an update program is available on <https://s.brother/cpeae/>, please download the files following the instructions on the website and steps below.

Note

- When using USB media to update the software, check that no data other than the update file is saved on the USB media being used before starting to update.

1 While pressing  (Automatic threading button), turn the main power to ON.

2 Touch .



3 Insert the USB media into the primary (top) USB port on the machine.

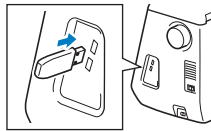

4 Touch .

→ When updating is finished, the completion message appears.

5 Turn the machine off, remove the USB media, and turn the machine on again.

Update Procedure Using Wireless LAN Connection

If the machine is connected to a wireless network with a strong, reliable connection, update files can be downloaded directly to the machine using this network.

For details on the wireless LAN connection, refer to page 28.

Memo

- The machine periodically checks if there is a new update file on the server. When there is a new update file, the wireless LAN key is displayed as .





1 Display page 10 of the settings screen.

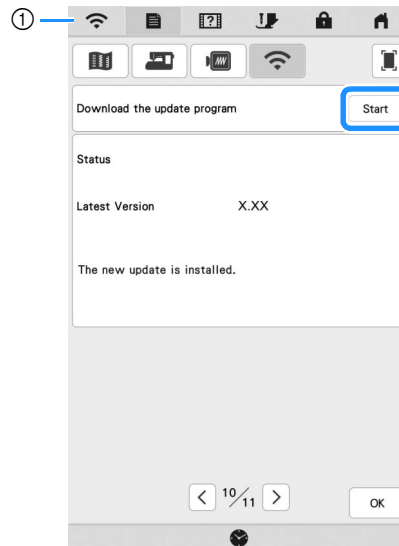

2 Touch .

- * The machine starts to download the update file, if there is a new update file on server.



- ① When the wireless LAN key appears as , touching  causes the machine to check if there is a new update file. If there is a new file, downloading begins.

Note

- Do not turn off the machine during the download.
- Touch  to pause the download. To restart, touch .

3 When downloading is finished, turn off the machine, then hold down  (Automatic threading button) while turning on the machine.

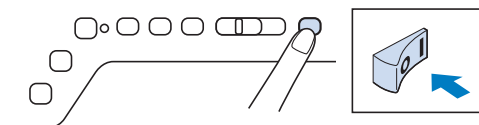

4 Touch  .

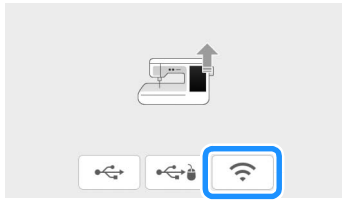

5 Touch  to update the machine.

* Do not turn off the machine during the update.

 **Memo**

- If there are changes or additions to functions, manuals available on the machine may be updated.

STITCH SETTING CHART

 **Memo**

- When any of the following stitches (reverse stitch patterns and reinforcement stitch patterns) are selected, pressing  (Reverse stitch button) will sew reverse stitches.

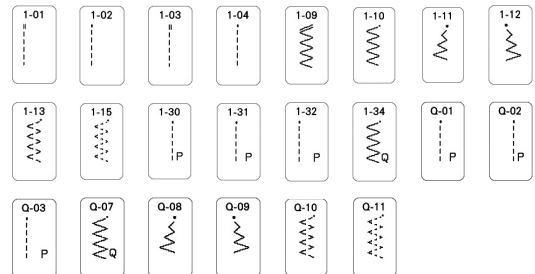

When any other stitch is selected, pressing  (Reverse stitch button) will sew reinforcement stitches.

- The stitch pattern symbols indicate the following.

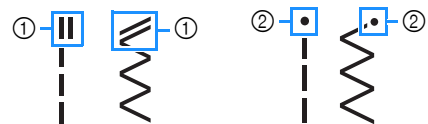





- ① Reverse stitch pattern
- ② Reinforcement stitch pattern

















- Advanced monogramming foot “N+” is displayed as “N” on the screen.
- Values and measurements provided in inches are approximate. Actual values are provided in the metric unit of measurement.















 **Note**

















- The presser foot that is displayed on each screen when Free motion mode is OFF/ON is shown in the table under “Presser foot”.

















* Twin needle can be used by attaching zigzag foot “J”.

Stitch	Presser foot	Stitch name/ Applications	Stitch width (mm (inch))	Stitch length (mm (inch))
			Auto. Manual	Auto. Manual
	J*/O	Straight stitch (Left) General sewing, gather, pintuck, etc.	0.0 (0) 0.0 - 7.0 (0 - 1/4)	2.5 (3/32) 0.2 - 5.0 (1/64 - 3/16)
	J*/O	Straight stitch (Left) General sewing, gather, pintuck, etc.	0.0 (0) 0.0 - 7.0 (0 - 1/4)	2.5 (3/32) 0.2 - 5.0 (1/64 - 3/16)
	J*/O	Straight stitch (Middle) General sewing, gather, pintuck, etc.	3.5 (1/8) 0.0 - 7.0 (0 - 1/4)	2.5 (3/32) 0.2 - 5.0 (1/64 - 3/16)
	J*/O	Straight stitch (Middle) General sewing, gather, pintuck, etc.	3.5 (1/8) 0.0 - 7.0 (0 - 1/4)	2.5 (3/32) 0.2 - 5.0 (1/64 - 3/16)

















Stitch	Presser foot	Stitch name/ Applications	Stitch width (mm inch))	Stitch length (mm inch))
			Auto. Manual	Auto. Manual
	J*/O	Triple stretch stitch General sewing for reinforcement and decorative topstitching	0.0 (0) 0.0 - 7.0 (0 - 1/4)	2.5 (3/32) 0.4 - 5.0 (1/64 - 3/16)
	J*/O	Stem stitch Reinforced stitching, sewing and decorative applications	1.0 (1/16) 0.0 - 7.0 (0 - 1/4)	2.5 (3/32) 0.4 - 5.0 (1/64 - 3/16)
	N*/O	Decorative stitch Decorative stitching, top stitching	0.0 (0) 0.0 - 7.0 (0 - 1/4)	2.5 (3/32) 0.4 - 5.0 (1/64 - 3/16)
	J/O	Basting stitch For basting.	0.0 (0) 0.0 - 7.0 (0 - 1/4)	20 (3/4) 5 - 30 (3/16 - 1-1/4)
	J*/O	Zigzag stitch For overcasting, mending.	3.5 (1/8) 0.0 - 7.0 (0 - 1/4)	1.4 (1/16) 0.0 - 5.0 (0 - 3/16)
	J*/O	Zigzag stitch For overcasting, mending.	3.5 (1/8) 0.0 - 7.0 (0 - 1/4)	1.4 (1/16) 0.0 - 5.0 (0 - 3/16)
	J*/O	Zigzag stitch (Right) Start from right needle position, zigzag sew at left.	3.5 (1/8) 2.5 - 5.0 (3/32 - 3/16)	1.4 (1/16) 0.3 - 5.0 (1/64 - 3/16)
	J*/O	Zigzag stitch (Left) Start from left needle position, zigzag sew at right.	3.5 (1/8) 2.5 - 5.0 (3/32 - 3/16)	1.4 (1/16) 0.3 - 5.0 (1/64 - 3/16)
	J*/O	2 steps elastic zigzag Overcasting (medium weight and stretch fabrics), tape and elastic	5.0 (3/16) 0.0 - 7.0 (0 - 1/4)	1.0 (1/16) 0.2 - 5.0 (1/64 - 3/16)
	J*/O	2 steps elastic zigzag Overcasting (medium weight and stretch fabrics), tape and elastic	5.0 (3/16) 0.0 - 7.0 (0 - 1/4)	1.0 (1/16) 0.2 - 5.0 (1/64 - 3/16)
	J*/O	3 steps elastic zigzag Overcasting (medium, heavyweight and stretch fabrics), tape and elastic	5.0 (3/16) 0.0 - 7.0 (0 - 1/4)	1.0 (1/16) 0.2 - 5.0 (1/64 - 3/16)
	G	Overcasting stitch Reinforcing of light and medium weight fabrics	3.5 (1/8) 2.5 - 5.0 (3/32 - 3/16)	2.0 (1/16) 0.4 - 5.0 (1/64 - 3/16)
	G	Overcasting stitch Reinforcing of heavyweight fabric	5.0 (3/16) 2.5 - 5.0 (3/32 - 3/16)	2.5 (3/32) 0.4 - 5.0 (1/64 - 3/16)
	G	Overcasting stitch Reinforcing of medium, heavyweight and easily friable fabrics or decorative stitching.	5.0 (3/16) 3.5 - 5.0 (1/8 - 3/16)	2.5 (3/32) 0.4 - 5.0 (1/64 - 3/16)
	J*/O	Overcasting stitch Reinforced seaming of stretch fabric	5.0 (3/16) 0.0 - 7.0 (0 - 1/4)	2.5 (3/32) 0.4 - 5.0 (1/64 - 3/16)
	J*/O	Overcasting stitch Reinforcing of medium stretch fabric and heavyweight fabric, decorative stitching	5.0 (3/16) 0.0 - 7.0 (0 - 1/4)	2.5 (3/32) 0.4 - 5.0 (1/64 - 3/16)















Stitch	Presser foot	Stitch name/ Applications	Stitch width (mm inch))	Stitch length (mm inch))
			Auto. Manual	Auto. Manual
	J*/O	Overcasting stitch Reinforcement of stretch fabric or decorative stitching	4.0 (3/16) 0.0 - 7.0 (0 - 1/4)	4.0 (3/16) 0.4 - 5.0 (1/64 - 3/16)
	J/O	Overcasting stitch Stretch knit seam	5.0 (3/16) 0.0 - 7.0 (0 - 1/4)	4.0 (3/16) 0.4 - 5.0 (1/64 - 3/16)
	J*/O	Single diamond overcast Reinforcement and seaming stretch fabric	6.0 (15/64) 0.0 - 7.0 (0 - 1/4)	3.0 (1/8) 0.4 - 5.0 (1/64 - 3/16)
	J*/O	Single diamond overcast Reinforcement of stretch fabric	6.0 (15/64) 0.0 - 7.0 (0 - 1/4)	1.8 (1/16) 0.4 - 5.0 (1/64 - 3/16)
	S	With side cutter Straight stitch while cutting fabrics	0.0 (0) 0.0 - 2.5 (0 - 3/32)	2.5 (3/32) 0.2 - 5.0 (1/64 - 3/16)
	S	With side cutter Zigzag stitch while cutting fabrics	3.5 (1/8) 3.5 - 5.0 (1/8 - 3/16)	1.4 (1/16) 0.0 - 5.0 (0 - 3/16)
	S	With side cutter Overcasting stitch while cutting fabrics	3.5 (1/8) 3.5 - 5.0 (1/8 - 3/16)	2.0 (1/16) 0.4 - 5.0 (1/64 - 3/16)
	S	With side cutter Overcasting stitch while cutting fabrics	5.0 (3/16) 3.5 - 5.0 (1/8 - 3/16)	2.5 (3/32) 0.4 - 5.0 (1/64 - 3/16)
	S	With side cutter Overcasting stitch while cutting fabrics	5.0 (3/16) 3.5 - 5.0 (1/8 - 3/16)	2.5 (3/32) 0.4 - 5.0 (1/64 - 3/16)
	J/O	Piecing stitch (Right) Piecework/patchwork 6.5 mm (approx. 1/4 inch) right seam allowance	5.5 (7/32) 0.0 - 7.0 (0 - 1/4)	2.0 (1/16) 0.2 - 5.0 (1/64 - 3/16)
	J/C	Piecing stitch (Middle) Piecework/patchwork	—	2.0 (1/16) 0.2 - 5.0 (1/64 - 3/16)
	J/O	Piecing stitch (Left) Piecework/patchwork 6.5 mm (approx. 1/4 inch) left seam allowance	1.5 (1/16) 0.0 - 7.0 (0 - 1/4)	2.0 (1/16) 0.2 - 5.0 (1/64 - 3/16)
	J/O	Hand-look quilting Quilting stitch made to look like hand quilting when using transparent nylon thread for the upper thread and a thread color matching the quilt for the bobbin thread. Sew with a tight thread tension so that the bobbin thread is visible from the right side of the fabric. Use a needle between 90/14 and 100/16.	0.0 (0) 0.0 - 7.0 (0 - 1/4)	2.5 (3/32) 0.4 - 5.0 (1/64 - 3/16)
	J/O	Quilting appliqué zigzag stitch Zigzag stitch for quilting and sewing on appliqué quilt pieces	3.5 (1/8) 0.0 - 7.0 (0 - 1/4)	1.4 (1/16) 0.0 - 5.0 (0 - 3/16)















Stitch	Presser foot	Stitch name/ Applications	Stitch width (mm (inch))	Stitch length (mm (inch))
			Auto. Manual	Auto. Manual
	J/O	Quilting appliqué stitch Quilting stitch for invisible appliqué or attaching binding	1.5 (1/16) 0.0 - 7.0 (0 - 1/4)	1.8 (1/16) 0.4 - 5.0 (1/64 - 3/16)
	J/O	Quilting stippling Background quilting	7.0 (1/4) 0.0 - 7.0 (0 - 1/4)	1.6 (1/16) 0.4 - 5.0 (1/64 - 3/16)
	R	Blind hem stitch Hemming woven fabrics * The stitch width setting is in neither millimeters nor inches.	00 3← - →3	2.0 (1/16) 0.4 - 5.0 (1/64 - 3/16)
	R	Blind hem stitch stretch Hemming stretch fabric * The stitch width setting is in neither millimeters nor inches.	00 3← - →3	2.0 (1/16) 0.4 - 5.0 (1/64 - 3/16)
	J*/O	Blanket stitch Appliqués, decorative blanket stitch	3.5 (1/8) 0.0 - 7.0 (0 - 1/4)	2.5 (3/32) 0.4 - 5.0 (1/64 - 3/16)
	J*/O	Blanket stitch Appliqués, decorative blanket stitch	2.5 (3/32) 0.0 - 7.0 (0 - 1/4)	2.5 (3/32) 0.4 - 5.0 (1/64 - 3/16)
	J*/O	Shell tuck edge Shell tuck edge finish on fabrics	4.0 (3/16) 0.0 - 7.0 (0 - 1/4)	2.5 (3/32) 0.2 - 5.0 (1/64 - 3/16)
	N*/O	Satin scallop stitch Decorating collar of blouse, edge of handkerchief	5.0 (3/16) 0.0 - 7.0 (0 - 1/4)	0.5 (1/32) 0.1 - 5.0 (1/64 - 3/16)
	N/O	Scallop stitch Decorating collar of blouse, edge of handkerchief	7.0 (1/4) 0.0 - 7.0 (0 - 1/4)	1.4 (1/16) 0.4 - 5.0 (1/64 - 3/16)
	J*/O	Patchwork join stitch Patchwork stitches, decorative stitching	4.0 (3/16) 0.0 - 7.0 (0 - 1/4)	1.2 (1/16) 0.2 - 5.0 (1/64 - 3/16)
	J*/O	Patchwork double overlock stitch Patchwork stitches, decorative stitching	5.0 (3/16) 0.0 - 7.0 (0 - 1/4)	2.5 (3/32) 0.4 - 5.0 (1/64 - 3/16)
	J*/O	Couching stitch Decorative stitching, attaching cord and couching	5.0 (3/16) 0.0 - 7.0 (0 - 1/4)	1.2 (1/16) 0.2 - 5.0 (1/64 - 3/16)
	J*/O	Smocking stitch Smocking, decorative stitching	5.0 (3/16) 0.0 - 7.0 (0 - 1/4)	1.6 (1/16) 0.4 - 5.0 (1/64 - 3/16)
	J*/O	Feather stitch Fagoting, decorative stitching	5.0 (3/16) 0.0 - 7.0 (0 - 1/4)	2.5 (3/32) 0.4 - 5.0 (1/64 - 3/16)
	J*/O	Fagoting cross stitch Fagoting, bridging and decorative stitching	5.0 (3/16) 0.0 - 7.0 (0 - 1/4)	2.5 (3/32) 0.4 - 5.0 (1/64 - 3/16)
	J*/O	Tape attaching Attaching tape to seam in stretch fabric	4.0 (3/16) 0.0 - 7.0 (0 - 1/4)	1.0 (1/16) 0.2 - 5.0 (1/64 - 3/16)

















Stitch	Presser foot	Stitch name/ Applications	Stitch width (mm (inch))	Stitch length (mm (inch))
			Auto. Manual	Auto. Manual
	J/O	Ladder stitch Decorative stitching	4.0 (3/16) 0.0 - 7.0 (0 - 1/4)	3.0 (1/8) 0.4 - 5.0 (1/64 - 3/16)
	J*/O	Rick-rack stitch Decorative top stitching	4.0 (3/16) 0.0 - 7.0 (0 - 1/4)	2.5 (3/32) 0.4 - 5.0 (1/64 - 3/16)
	J*/O	Decorative stitch Decorative stitching	1.0 (1/16) 0.0 - 7.0 (0 - 1/4)	2.5 (3/32) 0.4 - 5.0 (1/64 - 3/16)
	J*/O	Decorative stitch Decorative stitching	5.5 (7/32) 0.0 - 7.0 (0 - 1/4)	1.6 (1/16) 0.4 - 5.0 (1/64 - 3/16)
	N*/O	Serpentine stitch Decorative stitching and attaching elastic	5.0 (3/16) 0.0 - 7.0 (0 - 1/4)	1.0 (1/16) 0.2 - 5.0 (1/64 - 3/16)
	N*/O	Decorative stitch Decorative stitching and appliqué	6.0 (15/64) 0.0 - 7.0 (0 - 1/4)	1.0 (1/16) 0.2 - 5.0 (1/64 - 3/16)
	N/O	Decorative stippling stitch Decorative stitching	7.0 (1/4) 0.0 - 7.0 (0 - 1/4)	1.6 (1/16) 0.4 - 5.0 (1/64 - 3/16)
	N*/O	Hemstitching Decorative hems, triple straight at left	1.0 (1/16) 0.0 - 7.0 (0 - 1/4)	2.5 (3/32) 0.4 - 5.0 (1/64 - 3/16)
	N*/O	Hemstitching Decorative hems, triple straight at center	3.5 (1/8) 0.0 - 7.0 (0 - 1/4)	2.5 (3/32) 0.4 - 5.0 (1/64 - 3/16)
	N*/O	Hemstitching zigzag Decorative hems, top stitching	6.0 (15/64) 0.0 - 7.0 (0 - 1/4)	3.0 (1/8) 0.4 - 5.0 (1/64 - 3/16)
	N/O	Hemstitching Decorative hems, lace attaching pin stitch	3.5 (1/8) 0.0 - 7.0 (0 - 1/4)	2.5 (3/32) 0.4 - 5.0 (1/64 - 3/16)
	N/O	Hemstitching Decorative hems	3.0 (1/8) 0.0 - 7.0 (0 - 1/4)	3.5 (1/8) 0.4 - 5.0 (1/64 - 3/16)
	N/O	Hemstitching Decorative hems daisy stitch	6.0 (15/64) 0.0 - 7.0 (0 - 1/4)	3.0 (1/8) 0.4 - 5.0 (1/64 - 3/16)
	N/O	Hemstitching Heirloom, decorative hems	5.0 (3/16) 0.0 - 7.0 (0 - 1/4)	3.5 (1/8) 0.4 - 5.0 (1/64 - 3/16)
	N/O	Hemstitching Heirloom, decorative hems	5.0 (3/16) 0.0 - 7.0 (0 - 1/4)	3.5 (1/8) 0.4 - 5.0 (1/64 - 3/16)
	N*/O	Hemstitching Heirloom, decorative hems	5.0 (3/16) 0.0 - 7.0 (0 - 1/4)	3.5 (1/8) 0.4 - 5.0 (1/64 - 3/16)
	N*/O	Hemstitching Heirloom, decorative hems	5.0 (3/16) 0.0 - 7.0 (0 - 1/4)	4.0 (3/16) 0.4 - 5.0 (1/64 - 3/16)
	N*/O	Hemstitching Heirloom, decorative hems	4.0 (3/16) 0.0 - 7.0 (0 - 1/4)	2.5 (3/32) 0.4 - 5.0 (1/64 - 3/16)





































Stitch	Presser foot	Stitch name/ Applications	Stitch width (mm inch)	Stitch length (mm inch)
			Auto. Manual	Auto. Manual
	N*/O	Honeycomb stitch Heirloom, decorative hems	5.0 (3/16) 0.0 - 7.0 (0 - 1/4)	2.5 (3/32) 0.4 - 5.0 (1/64 - 3/16)
	N*/O	Honeycomb stitch Heirloom, decorative hems	6.0 (15/64) 0.0 - 7.0 (0 - 1/4)	3.5 (1/8) 0.4 - 5.0 (1/64 - 3/16)
	N*/O	Hemstitching Heirloom, decorative hems	6.0 (15/64) 0.0 - 7.0 (0 - 1/4)	1.6 (1/16) 0.4 - 5.0 (1/64 - 3/16)
	N/O	Hemstitching Heirloom, decorative hems	6.0 (15/64) 0.0 - 7.0 (0 - 1/4)	3.0 (1/8) 0.4 - 5.0 (1/64 - 3/16)
	N*/O	Hemstitching Heirloom, decorative hems	6.0 (15/64) 0.0 - 7.0 (0 - 1/4)	4.0 (3/16) 0.4 - 5.0 (1/64 - 3/16)
	N/O	Hemstitching Heirloom, decorative hems	4.0 (3/16) 0.0 - 7.0 (0 - 1/4)	2.5 (3/32) 0.4 - 5.0 (1/64 - 3/16)
	N*/O	Hemstitching Heirloom, decorative hems	5.0 (3/16) 0.0 - 7.0 (0 - 1/4)	2.0 (1/16) 0.4 - 5.0 (1/64 - 3/16)
	N*/O	Hemstitching Decorative hems and bridging stitch	6.0 (15/64) 0.0 - 7.0 (0 - 1/4)	2.0 (1/16) 0.4 - 5.0 (1/64 - 3/16)
	N*/O	Hemstitching Decorative hems. Fagoting, attaching ribbon	5.0 (3/16) 0.0 - 7.0 (0 - 1/4)	3.0 (1/8) 0.4 - 5.0 (1/64 - 3/16)
	N/O	Hemstitching Decorative hems, smocking	6.0 (15/64) 0.0 - 7.0 (0 - 1/4)	1.6 (1/16) 0.4 - 5.0 (1/64 - 3/16)
	N/O	Hemstitching Decorative hems, smocking	5.0 (3/16) 0.0 - 7.0 (0 - 1/4)	1.6 (1/16) 0.4 - 5.0 (1/16 - 3/16)
	N/O	Hemstitching Decorative hems, smocking	5.0 (3/16) 0.0 - 7.0 (0 - 1/4)	1.6 (1/16) 0.4 - 5.0 (1/64 - 3/16)
	N/O	Hemstitching Decorative hems	5.0 (3/16) 0.0 - 7.0 (0 - 1/4)	1.6 (1/16) 0.4 - 5.0 (1/64 - 3/16)
	N/O	Ladder stitch Decorative hems. Fagoting, attaching ribbon	7.0 (1/4) 0.0 - 7.0 (0 - 1/4)	1.6 (1/16) 0.4 - 2.5 (1/64 - 3/32)
	A	Narrow rounded buttonhole Buttonhole on light to medium weight fabrics	5.0 (3/16) 3.0 - 6.0 (1/8 - 15/64)	0.4 (1/64) 0.2 - 1.0 (1/64 - 1/16)
	A	Wide round ended buttonhole Buttonholes with extra space for larger buttons	5.5 (7/32) 3.5 - 6.0 (1/8 - 15/64)	0.4 (1/64) 0.2 - 1.0 (1/64 - 1/16)
	A	Tapered round ended buttonhole Reinforced waist tapered buttonholes	5.0 (3/16) 3.0 - 6.0 (1/8 - 15/64)	0.4 (1/64) 0.2 - 1.0 (1/64 - 1/16)















Stitch	Presser foot	Stitch name/ Applications	Stitch width (mm inch)	Stitch length (mm inch)
			Auto. Manual	Auto. Manual
	A	Round ended buttonhole Buttonholes with vertical bar tack in heavyweight fabrics	5.0 (3/16) 3.0 - 6.0 (1/8 - 15/64)	0.4 (1/64) 0.2 - 1.0 (1/64 - 1/16)
	A	Round ended buttonhole Buttonholes with bar tack	5.0 (3/16) 3.0 - 6.0 (1/8 - 15/64)	0.4 (1/64) 0.2 - 1.0 (1/64 - 1/16)
	A	Round double ended buttonhole Buttonholes for fine, medium to heavyweight fabrics	5.0 (3/16) 3.0 - 6.0 (1/8 - 15/64)	0.4 (1/64) 0.2 - 1.0 (1/64 - 1/16)
	A	Narrow squared buttonhole Buttonholes for light to medium weight fabrics	5.0 (3/16) 3.0 - 6.0 (1/8 - 15/64)	0.4 (1/64) 0.2 - 1.0 (1/64 - 1/16)
	A	Wide squared buttonhole Buttonholes with extra space for larger decorative buttons	5.5 (7/32) 3.5 - 6.0 (1/8 - 15/64)	0.4 (1/64) 0.2 - 1.0 (1/64 - 1/16)
	A	Squared buttonhole Heavy-duty buttonholes with vertical bar tacks	5.0 (3/16) 3.0 - 6.0 (1/8 - 15/64)	0.4 (1/64) 0.2 - 1.0 (1/64 - 1/16)
	A	Stretch buttonhole Buttonholes for stretch or woven fabrics	6.0 (15/64) 3.0 - 6.0 (1/8 - 15/64)	1.0 (1/16) 0.5 - 2.0 (1/32 - 1/16)
	A	Heirloom buttonhole Buttonholes for heirloom and stretch fabrics	6.0 (15/64) 3.0 - 6.0 (1/8 - 15/64)	1.5 (1/16) 1.0 - 3.0 (1/16 - 1/8)
	A	Bound buttonhole The first step in making bound buttonholes	5.0 (3/16) 0.0 - 6.0 (0 - 15/64)	2.0 (1/16) 0.2 - 4.0 (1/64 - 3/16)
	A	Keyhole buttonhole Buttonholes in heavyweight or thick fabrics for larger flat buttons	7.0 (1/4) 3.0 - 7.0 (1/8 - 1/4)	0.5 (1/32) 0.3 - 1.0 (1/64 - 1/16)
	A	Tapered keyhole buttonhole Buttonholes in medium to heavy weight fabrics for larger flat buttons	7.0 (1/4) 3.0 - 7.0 (1/8 - 1/4)	0.5 (1/32) 0.3 - 1.0 (1/64 - 1/16)
	A	Keyhole buttonhole Buttonholes with vertical bar tack for reinforcement in heavyweight or thick fabrics	7.0 (1/4) 3.0 - 7.0 (1/8 - 1/4)	0.5 (1/32) 0.3 - 1.0 (1/64 - 1/16)
	N/O	4 steps buttonhole 1 Left side of 4 step buttonhole	5.0 (3/16) 1.5 - 7.0 (1/16 - 1/4)	0.4 (1/64) 0.2 - 1.0 (1/64 - 1/16)
	N/O	4 steps buttonhole 2 Bar tack of 4 step buttonhole	5.0 (3/16) 1.5 - 7.0 (1/16 - 1/4)	0.4 (1/64) 0.2 - 1.0 (1/64 - 1/16)
	N/O	4 steps buttonhole 3 Right side of 4 step buttonhole	5.0 (3/16) 1.5 - 7.0 (1/16 - 1/4)	0.4 (1/64) 0.2 - 1.0 (1/64 - 1/16)



Stitch	Presser foot	Stitch name/ Applications	Stitch width (mm (inch))	Stitch length (mm (inch))
			Auto. Manual	Auto. Manual
	N/O	4 steps buttonhole 4 Bar tack of 4 step buttonhole	5.0 (3/16) 1.5 - 7.0 (1/16 - 1/4)	0.4 (1/64) 0.2 - 1.0 (1/64 - 1/16)
	A	Darning Darning of medium weight fabric	7.0 (1/4) 2.5 - 7.0 (3/32 - 1/4)	2.0 (1/16) 0.4 - 2.5 (1/64 - 3/32)
	A	Darning Darning of heavyweight fabric	7.0 (1/4) 2.5 - 7.0 (3/32 - 1/4)	2.0 (1/16) 0.4 - 2.5 (1/64 - 3/32)
	A	Bar tack Reinforcement at opening of pocket, etc.	2.0 (1/16) 1.0 - 3.0 (1/16 - 1/8)	0.4 (1/64) 0.3 - 1.0 (1/64 - 1/16)
	M	Button sewing Attaching buttons	3.5 (1/8) 2.5 - 4.5 (3/32 - 3/16)	—
	N/O	Eyelet For making eyelets, holes on belts, etc.	7.0 (1/4) 7.0 6.0 5.0 (1/4 15/64 3/16)	7.0 (1/4) 7.0 6.0 5.0 (1/4 15/64 3/16)
	N/O	Star eyelet For making star-shaped eyelets on holes.	—	—
	N/O	Diagonally left up (Straight) For attaching appliqué on tubular pieces of fabric and mitering corners	—	—
	N/O	Reverse (Straight) For attaching appliqué on tubular pieces of fabric and mitering corners	—	—
	N/O	Diagonally right up (Straight) For attaching appliqué on tubular pieces of fabric and mitering corners	—	—
	N/O	Sideways to left (Straight) For attaching appliqué on tubular pieces of fabric	—	—
	N/O	Sideways to right (Straight) For attaching appliqué on tubular pieces of fabric	—	—
	N/O	Diagonally left down (Straight) For attaching appliqué on tubular pieces of fabric and mitering corners	—	—
	N/O	Forward (Straight) For attaching appliqué on tubular pieces of fabric and mitering corners	—	—
	N/O	Diagonally right down (Straight) For attaching appliqué on tubular pieces of fabric and mitering corners	—	—

Stitch	Presser foot	Stitch name/ Applications	Stitch width (mm (inch))	Stitch length (mm (inch))
			Auto. Manual	Auto. Manual
	N/O	Sideways to left (Zigzag) For attaching appliqué on tubular pieces of fabric	—	—
	N/O	Sideways to right (Zigzag) For attaching appliqué on tubular pieces of fabric	—	—
	N/O	Forward (Zigzag) For attaching appliqué on tubular pieces of fabric and mitering corners	—	—
	N/O	Reverse (Zigzag) For attaching appliqué on tubular pieces of fabric and mitering corners	—	—
	J/C	Piecing stitch (Middle) Piecework/patchwork	—	2.0 (1/16) 0.2 - 5.0 (1/64 - 3/16)
	J/O	Piecing stitch (Right) Piecework/patchwork 6.5 mm (approx. 1/4 inch) right seam allowance	5.50 (7/32) 0.00 - 7.00 (0 - 1/4)	2.0 (1/16) 0.2 - 5.0 (1/64 - 3/16)
	J/O	Piecing stitch (Left) Piecework/patchwork 6.5 mm (approx. 1/4 inch) left seam allowance	1.50 (1/16) 0.00 - 7.00 (0 - 1/4)	2.0 (1/16) 0.2 - 5.0 (1/64 - 3/16)
	J/O	Hand-look quilting Quilting stitch made to look like hand quilting stitch	3.50 (1/8) 0.00 - 7.00 (0 - 1/4)	2.5 (3/32) 0.4 - 5.0 (1/64 - 3/16)
	J/O	Basting stitch Basting	3.50 (1/8) 0.00 - 7.00 (0 - 1/4)	20 (3/4) 5 - 30 (3/16 - 1-1/4)
	J/O	Stem stitch Reinforced stitching, sewing and decorative applications	1.00 (1/16) 0.00 - 7.00 (0 - 1/4)	2.5 (3/32) 0.4 - 5.0 (1/64 - 3/16)
	J/O	Quilting appliqué zigzag stitch Zigzag stitch for quilting and sewing on appliqué quilt pieces	3.50 (1/8) 0.00 - 7.00 (0 - 1/4)	1.6 (1/16) 0.0 - 5.0 (0 - 3/16)
	J/O	Zigzag stitch (Right) Start from right needle position, zigzag sew at left	3.50 (1/8) 2.50 - 5.00 (3/32 - 3/16)	1.6 (1/16) 0.3 - 5.0 (1/64 - 3/16)
	J/O	Zigzag stitch (Left) Start from left needle position, zigzag sew at right	3.50 (1/8) 2.50 - 5.00 (3/32 - 3/16)	1.6 (1/16) 0.3 - 5.0 (1/64 - 3/16)
	J/O	2 steps elastic zigzag Overcasting (medium weight and stretch fabrics), tape and elastic	5.00 (3/16) 0.00 - 7.00 (0 - 1/4)	1.0 (1/16) 0.2 - 5.0 (1/64 - 3/16)
	J/O	3 steps elastic zigzag Overcasting (medium, heavyweight and stretch fabrics), tape and elastic	5.00 (3/16) 0.00 - 7.00 (0 - 1/4)	1.0 (1/16) 0.2 - 5.0 (1/64 - 3/16)
	J/O	Quilting appliqué stitch Quilting stitch for invisible appliqué or attaching binding	2.00 (1/16) 0.00 - 7.00 (0 - 1/4)	2.0 (1/16) 0.4 - 5.0 (1/64 - 3/16)

Stitch	Presser foot	Stitch name/ Applications	Stitch width (mm inch))	Stitch length (mm inch))
			Auto. Manual	Auto. Manual
	J/O	Shell tuck edge Shell tuck edge finish on fabrics	4.00 (3/16) 0.00 - 7.00 (0 - 1/4)	2.5 (3/32) 0.2 - 5.0 (1/64 - 3/16)
	J/O	Blanket stitch Appliqués, decorative blanket stitch	3.50 (1/8) 0.00 - 7.00 (0 - 1/4)	2.5 (3/32) 0.4 - 5.0 (1/64 - 3/16)
	J/O	Quilting stippling Background quilting	7.00 (1/4) 0.00 - 7.00 (0 - 1/4)	1.6 (1/16) 0.4 - 5.0 (1/64 - 3/16)
	J/O	Overcasting stitch Stretch knit seam	5.00 (3/16) 0.00 - 7.00 (0 - 1/4)	4.0 (3/16) 0.4 - 5.0 (1/64 - 3/16)
	J/O	Tape attaching Attaching tape to seam in stretch fabric	5.50 (7/32) 0.00 - 7.00 (0 - 1/4)	1.4 (1/16) 0.2 - 5.0 (1/64 - 3/16)
	N/O	Serpentine stitch Decorative stitching and attaching elastic	5.00 (3/16) 0.00 - 7.00 (0 - 1/4)	2.0 (1/16) 0.2 - 5.0 (1/64 - 3/16)
	J/O	Feather stitch Fagoting, decorative stitching	5.00 (3/16) 0.00 - 7.00 (0 - 1/4)	2.5 (3/32) 0.4 - 5.0 (1/64 - 3/16)
	J/O	Fagoting cross stitch Fagoting, bridging and decorative stitching	5.00 (3/16) 0.00 - 7.00 (0 - 1/4)	2.5 (3/32) 0.4 - 5.0 (1/64 - 3/16)
	J/O	Couching stitch Decorative stitching, attaching cord and couching	5.00 (3/16) 0.00 - 7.00 (0 - 1/4)	1.2 (1/16) 0.2 - 5.0 (1/64 - 3/16)
	J/O	Patchwork double overlock stitch Patchwork stitches, decorative stitching	5.00 (3/16) 0.00 - 7.00 (0 - 1/4)	2.5 (3/32) 0.4 - 5.0 (1/64 - 3/16)
	J/O	Smocking stitch Smocking, decorative stitching	5.00 (3/16) 0.00 - 7.00 (0 - 1/4)	1.6 (1/16) 0.4 - 5.0 (1/64 - 3/16)
	J/O	Rick-rack stitch Decorative top stitching	4.00 (3/16) 0.00 - 7.00 (0 - 1/4)	2.5 (3/32) 0.4 - 5.0 (1/64 - 3/16)
	N/O	Decorative stitch Decorative stitching and appliqué	6.00 (15/64) 0.00 - 7.00 (0 - 1/4)	1.0 (1/16) 0.2 - 5.0 (1/64 - 3/16)
	J/O	Decorative stitch Decorative stitching	5.50 (7/32) 0.00 - 7.00 (0 - 1/4)	1.6 (1/16) 0.4 - 5.0 (1/64 - 3/16)
	N/O	Hemstitching Heirloom, decorative hems	5.00 (3/16) 0.00 - 7.00 (0 - 1/4)	2.0 (1/16) 0.4 - 5.0 (1/64 - 3/16)
	N/O	Hemstitching Decorative hems and bridging stitch	6.00 (15/64) 0.00 - 7.00 (0 - 1/4)	2.0 (1/16) 0.4 - 5.0 (1/64 - 3/16)
	J/O	Single diamond overcast Reinforcement and seaming stretch fabric	6.00 (15/64) 0.00 - 7.00 (0 - 1/4)	3.0 (1/8) 0.4 - 5.0 (1/64 - 3/16)
	J/O	Overcasting stitch Reinforcement of stretch fabric or decorative stitching	4.00 (3/16) 0.00 - 7.00 (0 - 1/4)	4.0 (3/16) 0.4 - 5.0 (1/64 - 3/16)

Stitch	Presser foot	Stitch name/ Applications	Stitch width (mm inch))	Stitch length (mm inch))
			Auto. Manual	Auto. Manual
	N/O	Appliqué stitch Appliqués, decorative stitch	3.00 (1/8) 0.00 - 7.00 (0 - 1/4)	2.0 (1/16) 0.4 - 5.0 (1/64 - 3/16)
	N/O	Blanket stitch Appliques, decorative blanket stitch	4.00 (3/16) 0.00 - 7.00 (0 - 1/4)	2.5 (3/32) 0.4 - 5.0 (1/64 - 3/16)
	N/O	Decorative stitch Decorative stitching	7.00 (1/4) 0.00 - 7.00 (0 - 1/4)	2.5 (3/32) 0.4 - 5.0 (1/64 - 3/16)
	N/O	Decorative stitch Decorative stitching	7.00 (1/4) 0.00 - 7.00 (0 - 1/4)	2.5 (3/32) 0.4 - 5.0 (1/64 - 3/16)
	N/O	Decorative stitch Decorative stitching	7.00 (1/4) 0.00 - 7.00 (0 - 1/4)	2.5 (3/32) 0.4 - 5.0 (1/64 - 3/16)
	N/O	Decorative stitch Decorative stitching	7.00 (1/4) 0.00 - 7.00 (0 - 1/4)	2.5 (3/32) 0.4 - 5.0 (1/64 - 3/16)
	N/O	Decorative stitch Decorative stitching	7.00 (1/4) 0.00 - 7.00 (0 - 1/4)	2.5 (3/32) 0.4 - 5.0 (1/64 - 3/16)
	N/O	Decorative stitch Decorative stitching	7.00 (1/4) 0.00 - 7.00 (0 - 1/4)	2.5 (3/32) 0.4 - 5.0 (1/64 - 3/16)
	N/O	Decorative stitch Decorative stitching	7.00 (1/4) 0.00 - 7.00 (0 - 1/4)	2.5 (3/32) 0.4 - 5.0 (1/64 - 3/16)
	N/O	Decorative stitch Decorative stitching	7.00 (1/4) 0.00 - 7.00 (0 - 1/4)	0.4 (1/64) 0.1 - 5.0 (1/64 - 3/16)
	X	Free motion couching stitch Free motion couching stitch	3.50 (1/8) 2.75 - 3.75 (3/32 - 1/8)	-
	J/O	Hand-look quilting Quilting stitch made to look like hand quilting stitch	0.0 (0) 0.0 - 7.0 (0 - 1/4)	-
	J/O	Hand-look quilting Quilting stitch made to look like hand quilting stitch	0.0 (0) 0.0 - 7.0 (0 - 1/4)	-
	J/O	Hand-look quilting Quilting stitch made to look like hand quilting stitch	0.0 (0) 0.0 - 7.0 (0 - 1/4)	-
	N/O	Tapering stitch Stitch pattern can be tapered at the beginning or at the end of sewing.	7.0 (1/4) 2.5 - 7.0 (3/32 - 1/4)	1.0 (1/16) 0.1 - 5.0 (1/64 - 3/16)
	N/O	Tapering stitch Stitch pattern can be tapered at the beginning or at the end of sewing.	5.0 (3/16) 2.5 - 7.0 (3/32 - 1/4)	2.5 (3/32) 1.4 - 5.0 (1/16 - 3/16)
	N/O	Tapering stitch Stitch pattern can be tapered at the beginning or at the end of sewing.	5.0 (3/16) 2.5 - 7.0 (3/32 - 1/4)	2.5 (3/32) 1.4 - 4.0 (1/16 - 3/16)

Stitch	Presser foot	Stitch name/ Applications	Stitch width (mm (inch))	Stitch length (mm (inch))
			Auto. Manual	Auto. Manual
	N/O	Tapering stitch Stitch pattern can be tapered at the beginning or at the end of sewing.	7.0 (1/4) 2.5 - 7.0 (3/32 - 1/4)	2.0 (1/16) 1.0 - 4.0 (1/16 - 3/16)
	N/O	Tapering stitch Stitch pattern can be tapered at the beginning or at the end of sewing.	7.0 (1/4) 2.5 - 7.0 (3/32 - 1/4)	3.5 (1/8) 2.5 - 4.0 (3/32 - 3/16)
	N/O	Tapering stitch Stitch pattern can be tapered at the beginning or at the end of sewing.	7.0 (1/4) 2.5 - 7.0 (3/32 - 1/4)	3.0 (1/8) 2.0 - 5.0 (1/16 - 3/16)
	N/O	Tapering stitch Stitch pattern can be tapered at the beginning or at the end of sewing.	7.0 (1/4) 3.0 - 7.0 (1/8 - 1/4)	3.0 (1/8) 2.5 - 5.0 (3/32 - 3/16)
	N/O	Tapering stitch Stitch pattern can be tapered at the beginning or at the end of sewing.	7.0 (1/4) 3.0 - 7.0 (1/8 - 1/4)	2.5 (3/32) 2.5 - 4.0 (3/32 - 3/16)
	N/O	Tapering stitch Stitch pattern can be tapered at the beginning or at the end of sewing.	7.0 (1/4) 2.5 - 7.0 (3/32 - 1/4)	2.5 (3/32) 1.4 - 4.0 (1/16 - 3/16)
	N/O	Tapering stitch Stitch pattern can be tapered at the beginning or at the end of sewing.	7.0 (1/4) 3.0 - 7.0 (1/8 - 1/4)	2.5 (3/32) 2.0 - 4.0 (1/16 - 3/16)
	N/O	Tapering stitch Stitch pattern can be tapered at the beginning or at the end of sewing.	7.0 (1/4) 4.0 - 7.0 (3/16 - 1/4)	3.0 (1/8) 2.5 - 4.0 (3/32 - 3/16)
	N/O	Tapering stitch Stitch pattern can be tapered at the beginning or at the end of sewing.	7.0 (1/4) 2.5 - 7.0 (3/32 - 1/4)	1.0 (1/16) 0.4 - 5.0 (1/64 - 3/16)
	N/O	Tapering stitch Stitch pattern can be tapered at the beginning or at the end of sewing.	6.0 (15/64) 4.0 - 7.0 (3/16 - 1/4)	0.3 (1/64) 0.2 - 2.0 (1/64 - 1/16)
	N/O	Tapering stitch Stitch pattern can be tapered at the beginning or at the end of sewing.	6.0 (15/64) 4.0 - 7.0 (3/16 - 1/4)	0.3 (1/64) 0.2 - 2.0 (1/64 - 1/16)
	N/O	Tapering stitch Stitch pattern can be tapered at the beginning or at the end of sewing.	7.0 (1/4) 3.5 - 7.0 (1/8 - 1/4)	0.3 (1/64) 0.1 - 2.0 (1/64 - 1/16)
	N/O	Tapering stitch Stitch pattern can be tapered at the beginning or at the end of sewing.	7.0 (1/4) 4.0 - 7.0 (3/16 - 1/4)	3.5 (1/8) 2.5 - 4.0 (3/32 - 3/16)
	N/O	Tapering stitch Stitch pattern can be tapered at the beginning or at the end of sewing.	7.0 (1/4) 4.0 - 7.0 (3/16 - 1/4)	2.5 (3/32) 2.0 - 4.0 (1/16 - 3/16)
	N/O	Tapering stitch Stitch pattern can be tapered at the beginning or at the end of sewing.	7.0 (1/4) 4.5 - 7.0 (3/16 - 1/4)	2.5 (3/32) 2.0 - 4.0 (1/16 - 3/16)

Stitch	Presser foot	Stitch name/ Applications	Stitch width (mm (inch))	Stitch length (mm (inch))
			Auto. Manual	Auto. Manual
	N/O	Tapering stitch Stitch pattern can be tapered at the beginning or at the end of sewing.	7.0 (1/4) 2.5 - 7.0 (3/32 - 1/4)	2.5 (3/32) 1.6 - 4.0 (1/16 - 3/16)
	N/O	Tapering stitch Stitch pattern can be tapered at the beginning or at the end of sewing.	7.0 (1/4) 4.0 - 7.0 (3/16 - 1/4)	2.5 (3/32) 2.0 - 4.0 (1/16 - 3/16)

INDEX

A

Accessory compartment	11
Adjustments	
screen	183
Advanced multi-function foot controller	51
Air vent	9
Alphabet characters	
embroidery	107
Appliqué	
quilting	75
using an embroidery frame pattern	155
Arrow keys	100
Automatic fabric sensor system	62
Automatic thread cutting key	60
Automatic threading button	10, 36

B

Ball point needle	44
Bar tacks	88
Blind hem stitches	79
Block move key	101
Bobbin	
pulling up the bobbin thread	35
setting	34
winding	30
Bobbin case	
cleaning	181
Bobbin clip	11
Bobbin cover	9, 34
Bobbin threading	
pulling up the bobbin thread	35
setting the bobbin	34
winding the bobbin	30
Bobbin winder	9
Bobbin winding switch	32
Border key	114, 117
Button sewing	89
4 hole buttons	89
shank	89
Buttonhole lever	9
Buttonholes	
four-step	85
odd-shaped/buttons that do not fit the button holder plate	85
one-step	83

C

Character/Decorative Stitches	
adjustments	95
retrieving	98
saving	97
Cleaning	
race	181
Clock	14
Color shuffling function	121
Compact dual feed foot	46
Cord guide bobbin cover	71
Couching patterns	156

D

Darning	87
Dart seam	69
Decorative fill pattern	159
Denim	44
Deselect region setting	119

E

Echo quilting	78, 159
Eco mode	23
Editing	
embroidery edit	111
Embroidery	
2-point embroidery positioning function	133
adjusting the speed	150
automatic thread cutting function (End color trim)	149
key functions	124
resuming embroidery after turning off the power	141
selecting patterns	105
thread color display	151
thread trimming function (Jump stitch trim)	150
Embroidery appliqué	139
Embroidery edit	
changing the thread color	120
key functions	111
repeated patterns	114
Embroidery foot "W+" with LED pointer	103
Embroidery frames	
attaching	129
inserting fabric	127
removing	129
types	127
using the embroidery sheet	128
Embroidery needle plate cover	138
Embroidery patterns	
checking the position	132
editing	111
embroidering	137
linked characters	152
retrieving	154
saving	153
selecting	105
using a frame pattern to make an appliqué	155
Embroidery sheet	128
Embroidery unit	104
Error messages	192
Eyelet	90

F

Fabric	44
Fabrics	
sewing heavyweight fabrics	65
sewing lightweight fabrics	66
sewing stretch fabrics	66, 85
Fagoting	82
Favorite color scheme	123
Feed dogs	9, 76
Flat bed attachment	9, 104
Flat fell Seam	70
Foot controller	9, 51
Advanced Multi-Function Foot Controller	51
Free motion quilting	
free motion echo quilting foot "E"	78
free motion open toe quilting foot "O"	77
free motion quilting foot "C"	76
Free motion sewing mode	76

G

Gathering	69
Grid direction key	100
Guideline marker	60

H

Handle	9
--------------	---

Handwheel	9
Home page screen	16

I

Image key	113
Insert key	101

K

Key functions	
embroidery	124
embroidery edit	111
MY CUSTOM STITCH	99
utility stitches	18
Knee lifter	9, 62

L

L/R Shift	58
LCD screen	9, 16
light	21
Leather	66

M

Machine help key	24
Main power switch	9
Metallic thread	31
MPEG-4 (MP4) videos	26
Multi-directional sewing	90
MY CUSTOM STITCH	99
retrieving	101
My Design Center	161
My Design Snap App	179
My Stitch Monitor App	178

N

Needle	44
changing the needle	42
changing the needle position	67
mode	17
twin needle	39
Needle bar thread guide	9, 40
Needle mode selection key	39
Needle plate	9
Needle position	62, 67
Needle position button	10

O

Operation buttons	9, 10
Overcasting	72

P

Piecing	73
1/4 piecing foot with guide	74
Pintuck	70
Pivoting	61
Power cord	14
Power cord receptacle	9
Presser foot	
pressure	62
removing	45
types	197
Presser foot code	124
Presser foot holder	9, 45
Presser foot holder screw	9
Presser foot lever	9, 65
Presser foot lifter button	10
Presser foot/Needle exchange key	39, 42, 45
Pretension disk	9, 32, 33

Q

Quilting	73
free motion	76
with satin stitches	75

R

Race	181
Reinforcement stitch	55
Reinforcement stitch button	10
Repeated patterns	114
Retrieving	
character/decorative stitch patterns	98
embroidery patterns	154
machine's memory	98, 154
MY CUSTOM STITCH designs	101
stitch settings	59
utility stitches	59
Reverse stitch button	10
Reverse/Reinforcement stitches	55

S

Satin stitches	75
Saving	
character/decorative stitches	97
embroidery patterns	153
machine's memory	97, 153
stitch settings	59
utility stitches	59
Scallop stitches	81
Screen saver	23
Set key	100
Settings	
automatic thread cutting	60, 149
embroidery settings	22
general settings	21
machine settings key	20
sewing settings	20
stitch length	58
stitch width	57
thread tension	58, 147
thread trimming	150
Sewing speed controller (speed control slide)	9, 10, 49
Sewing type selection key	25
Shelltuck stitches	81
Shutoff support mode	23
Single/Triple stitching key	100
Smocking stitches	81
Speaker	21
Specifications	194
Spool cap	9
Spool net	31
Spool pin	9
Spool stand	34, 41
Stabilizer	126
Start/Stop button	10
Starting point key	151
Step stitch patterns	96
Stippling	159
Stitch setting chart	197
Stitch tapering function	93
Straight stitch foot	63
Straight stitch needle plate	63
Straight stitches	67
Supplemental spool pin	9, 30, 40

T

Tape or elastic attaching	82
Thread	44
thread tension	58, 147
Thread color display	151
Thread color palette	120

Thread cutter 9, 51
 Thread cutter button 10
 Thread guide 9, 31, 33, 40
 Thread guide plate 9, 33, 37
 Thread marks 117
 Touch pen 16, 183
 Transparent nylon thread 32, 44
 Trial key 132
 Troubleshooting 184
 Tutorial video 25
 Twin needle 39

U

Updating 196
 Upper thread 44
 Upper threading
 twin needle mode 39
 using the Automatic threading button 36
 USB mouse 30
 USB port 9
 Utility stitches
 key functions 18
 pattern explanation key 26
 retrieving 59
 saving 59
 sewing type selection key 25
 stitch setting chart 197

V

Vinyl fabrics 66

Z

Zigzag stitches 71
 Zipper insertion
 centered 91
 side 91







My Stitch Monitor is a mobile app that monitors the operating conditions of your machine.

Visit the Google Play™ or App Store to download.



Google Play™



App Store



My Design Snap is a mobile app that you can position your embroidery designs on the fabric, by capturing image of the hooped fabric and sending the image to your machine.

Visit the Google Play™ or App Store to download.



Google Play™



App Store



Design Database Transfer is a dedicated Windows application for wirelessly transferring embroidery data from a computer to the machine. This application can also be used to view and manage embroidery data.

Visit us at <https://s.brother/caeka/> to download the application.

Various optional accessories are available to be purchased separately.

Visit our website <https://s.brother/coeka/>.



Please visit us at <https://s.brother/cpeae/> where you can get product support and answers to frequently asked questions (FAQs).



Be sure to install the latest software.

A variety of functional improvements are being performed in the latest version.



Brother SupportCenter is a mobile app that provides the support information for your Brother product.

Visit the Google Play™ or App Store to download.



Google Play™



App Store

This machine is approved for use in the country of purchase only. Local Brother companies or their dealers will only support machines purchased in their own countries.

